

# INSTRUCTIONS

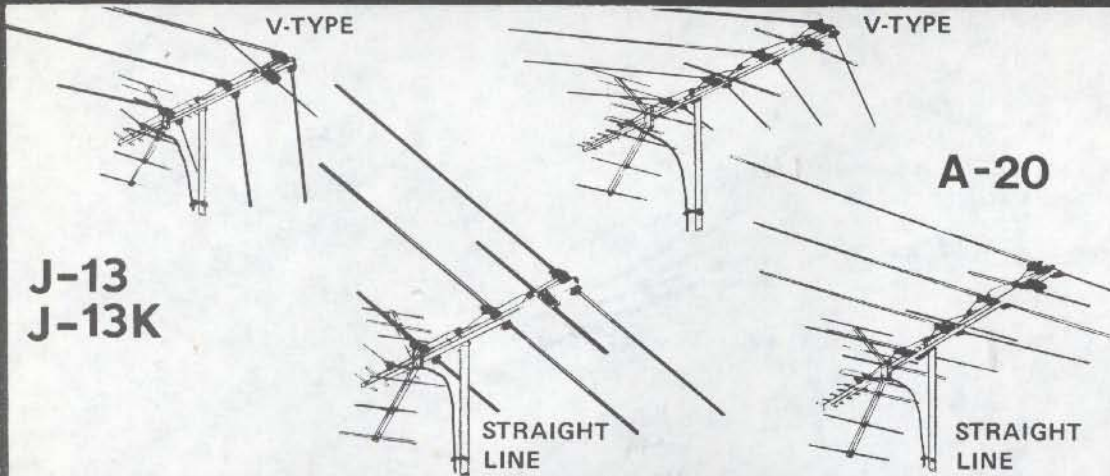

MODEL	CONTENTS
A-20 J-13	Antenna and corner reflectors, U-bolt assembly, band separator.
J-13K	Antenna and corner reflectors, U-bolt assembly, band separator and coupler, mast, lead-in wire, mounting brackets, standoffs.

There are two configurations: STRAIGHT LINE and V-TYPE. Use Straight Line in areas where channels 2 to 6 are strongest; where channels 7 to 13 are strongest, use V-Type.

**WARNING** INSTALLATION OF THIS PRODUCT NEAR POWER LINES IS DANGEROUS. FOR YOUR SAFETY, FOLLOW THE INSTALLATION DIRECTIONS.

**1**

- Open antenna rods
- For V-Type configuration, swing open until rods snap into FIRST slot on insulator – for Straight Line configuration, push rods beyond first slot, into SECOND slot.

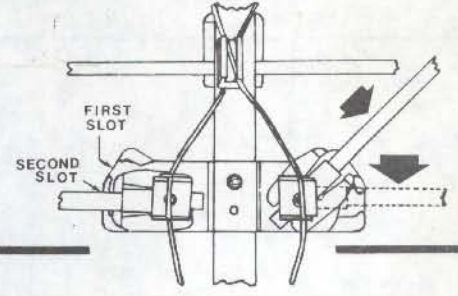

**2**

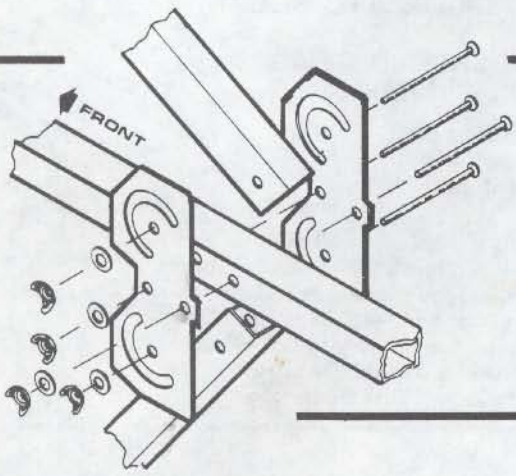

- Install corner reflectors on antenna boom with brackets and hardware as shown
- Be sure corner reflector arms snap in place at proper angle on bracket.

**3**

- Attach U-bolt assembly to antenna
- Insert mast in U-bolt assembly and tighten
- Insert plastic end caps in antenna boom and corner reflector arms.

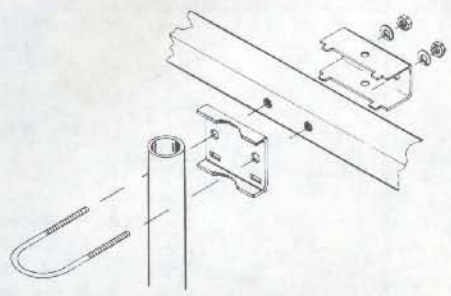

• INSTRUCTIONS CONTINUED ON OTHER SIDE •

# GEMINI

Gemini Industries Inc., 215 Entin Rd., Clifton, N.J. 07014 (201) 471-9050

## MODELS J-13, J-13K, A-20

# INSTRUCTIONS

## 4

- Split antenna wire about six inches
- Strip wire back about one inch
- Attach wires to terminals
- Place wire between washers and tighten wing nuts.

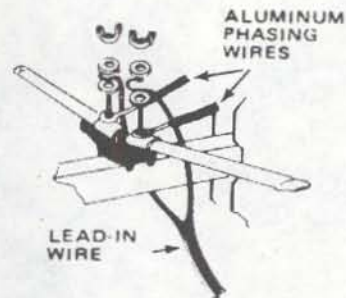
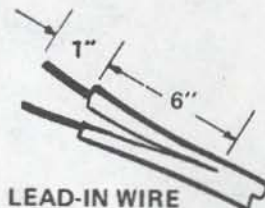

## 5

### CAUTION

KEEP LADDER AND ANTENNA AWAY FROM POWER LINES  
CONTACT MAY CAUSE ELECTROCUTION



- POWER LINES SHOULD BE AS FAR AWAY AS POSSIBLE
- Attach mast standoff to mast
- Insert wire in standoff and tighten standoff with pliers.

- Assemble U-bolts in wall mounts with lockwashers and nuts
- Secure mounts to wall with wood screws
- Separate mounts at least two feet
- Insert mast with assembled antenna into both U-bolts
- Face antenna toward TV station
- Tighten U-bolt nuts securely.

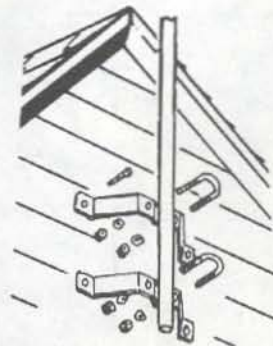

## 6

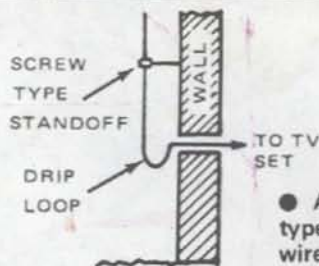

- Attach lead-in wire to house with screw-type standoffs
- Tighten standoffs after wire is installed
- Avoid sharp bends in lead-in wire
- Twist wire once about every foot
- Form a drip loop where wire enters house.

- Install VHF/UHF signal splitter as shown



# GEMINI

Gemini Industries Inc., 215 Entin Rd., Clifton, N.J. 07014 (201) 471-9050

## MODELS J-13, J-13K, A-20