

INTRODUCTION

The Owners Manual for your new Airstream Motorhome is designed to respond to the most frequent inquiries regarding the operation, function and care of the many systems that make modern motor homing a joy.

The Airstream Interstate Motorhome is integrated into a Sprinter Van, designed and manufactured by Sprinter. Operation of the Sprinter, its engine, power train, and other related components are discussed in the Sprinter Operator's Manual and other literature provided by Sprinter. As a point of reference, those systems discussed in the Sprinter literature are warranted by Sprinter or their suppliers.

Airstream realizes our customers possess varying degrees of expertise in the area of repairing and maintaining the appliances in their motorhome. For this reason, the service and trouble-shooting information found in this manual is directed toward those with average mechanical skills. We also realize you may be more familiar in one area than you are in another. Only you know your capabilities and limitations.

We want you to use this manual, and hope you will find the information contained in it helpful, however, should you ever feel you may be "getting in over your head" please see your dealer to have the repairs made.

The operation and care of component parts such as, refrigerator, furnace, water heater and others are briefly explained in this manual. However, you will also

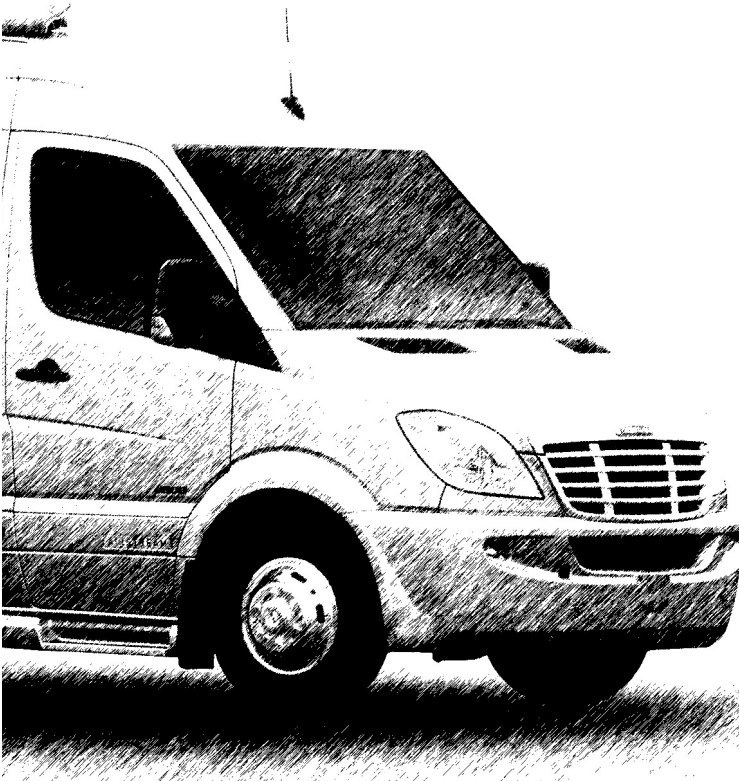

find the complete manufacturer's information supplied in a packet included with this manual.

Note: All information, illustrations and specifications contained in the literature are based on the latest product information available at the time of publication approval. Airstream reserves the right to make changes if and when new materials and/or production techniques are developed that can improve the quality of its product, or when material substitutions are necessary due to availability.

We have provided many important safety messages in this manual. Always read and obey all safety messages.



WARNING indicates a potentially hazardous situation that, if not avoided, could result in death or serious injury.



CAUTION indicates a potentially hazardous situation that, if not avoided, could result in minor or moderate injury.

NOTICE: used without the safety alert symbol indicates a situation that could result in property damage if not avoided.

NOTE: Important information regarding the maintenance of your recreational vehicle.

(Optional)

This denotes items that may be an option on all or particular models. Additionally, some optional items can only be included during the manufacturing phase and cannot be added.

The inclusion of optional items does not imply or suggest the availability, application suitability, or inclusion for any specific unit.

NOTICE: Your Sprinter Van Operator's and Warranty Manuals contain important cautions, warnings, operational, and warranty information on the Sprinter and its components. All information in the Sprinter manual should be reviewed and followed for your safety. The Airstream Interstate Owner's Manual may provide addition information and tips on the use of the Van as a motorhome, however, no information in the Airstream manual should be interpreted as advice or directions to disregard or void the warnings, cautions, or other information contained in the Sprinter's manuals.

Important Safety Precautions

You'll find many safety recommendations on this page and throughout this manual. The recommendations on the next two pages are the ones we

INTRODUCTION

consider to be the most important. Most are covered in depth in later sections of this manual.

Mold (See page D-18)

There are mold and mold spores throughout the indoor and outdoor environment. There is no practical way to eliminate all mold and mold spores in the indoor environment; the way to control indoor mold growth is to control moisture.

Towing and Weight Distribution (See section B of this manual)

Weight distribution is an important factor when loading your motorhome. A recreational vehicle with the cargo distributed properly will result in efficient, trouble-free towing. Be sure to follow the instructions in this manual.

Generator Safety (See page H-10)

Do not operate the generator in an enclosed building or in a partly enclosed area such as a garage. Nor should the generator be operated while sleeping. Be sure to follow all instructions and warnings in this manual and the generator manufacturer's manual.

Appliances and Equipment (See LP section on G-1 and Appliances on page I-1)

The appliances (stove, outdoor grills, etc.) and equipment (hot water heater, furnace generator, etc.) typically operate on propane gas. Propane gas is flammable and is contained under high pressure. Improper use may result in a fire and/or explosion. Be sure to follow all instructions and warnings in this manual (see LP Plumbing section) as well as the specific owners' manuals of the appliances and equipment.

Tire Safety (See pages C-3 through C-5 and the Tire Safety Manual Addendum)

Properly maintained tires improve the steering, stopping, traction, and load-carrying capability of your vehicle. Under inflated tires and overloaded vehicles are a major cause of tire failure. Be sure to read the Tire Safety Manual Addendum included with your owner's packet.

Chemical Sensitivity

Chemical Sensitivity

After you first purchase your new recreational vehicle and sometimes after it has been closed up for an extended period of time you may notice a strong odor and chemical sensitivity. This is not a defect in your recreational vehicle. Like your home, there are many different products used in the construction of recreational vehicles such as carpet, linoleum, plywood, insulation, upholstery, etc. Formaldehyde is also the by-product of combustion and numerous household products, such as some paints, coatings and cosmetics. However, recreational vehicles are much smaller than your home and therefore the exchange of air inside a recreational vehicle is significantly less than a home. These products, when new or when exposed to elevated temperatures and/or humidity, may “off-gas” different chemicals, including formaldehyde. This off-gassing, in combination with the minimal air exchange, may cause you to experience irritation of the eyes, nose, and throat and sometimes headache, nausea, and a variety of asthma-like symptoms. Elderly persons and young children, as well as anyone with a history of asthma, allergies, or lung problems, may be more susceptible to the effects of off-gassing.

Most of the attention regarding chemical off-gassing surrounds formaldehyde. Formaldehyde is a naturally occurring substance. It is also a key industrial

chemical used in the manufacture of the numerous consumer products which we referred to above and used in the construction of recreational vehicles. Trace levels of formaldehyde are also released from smoking, cooking, use of soaps and detergents such as carpet shampoos, cosmetics, and many other household products. Some people are very sensitive to formaldehyde while others may not have any reaction to the same levels of formaldehyde. Amounts released decrease over time.

Your Airstream motorhome was manufactured using low formaldehyde emitting (LFE) wood products, which is the typical usage in the recreation vehicle industry. Formaldehyde has an important role in the adhesives used to bind wood products used in recreation vehicles. The wood products in your motorhome are designed to emit formaldehyde at or lower than industry guidelines and should not produce symptoms in most individuals.

While LFE wood products typically do not emit formaldehyde at a level that would cause symptoms in most individuals, it is possible, though not likely, for that to occur when the trailer is not properly ventilated. Ventilation is an essential requirement for trailer use, for many reasons. Any effects of formaldehyde can be greatly reduced by actions such as opening windows, opening roof vents, running the air conditioner, or some combination thereof. In addition, the emission of formaldehyde by these products naturally decreases rapidly over time.

Airstream strongly suggests that you take measures to properly ventilate your motorhome on a regular basis.

Ventilation

To reduce or lessen exposure to chemicals from off-gassing it is of utmost importance that you ventilate your recreational vehicle. Ventilation should occur frequently after purchase and at times when the temperatures and humidity are elevated. Remember off-gassing is accelerated by heat and humidity. Open windows, exhaust vents, and doors. Operate ceiling and/or other fans, roof air conditioners, and furnaces and use a fan to force stale air out and bring fresh air in. Decreasing the flow of air by sealing the recreational vehicle increases the formaldehyde level in the indoor air. Please also follow the recommendations contained in Chapter 2 regarding tips to avoid condensation problems. Many of the recommendations contained in Chapter 2 will assist in avoiding exposure to chemicals that off-gas.

If you have any questions with respect to proper ventilation of your motorhome, please do not hesitate to contact your dealer or Airstream.

Chemical gassing is not a “Defect” in your recreational vehicle and is not covered by the Limited Warranty. Please follow the recommendations in this manual to address this concern.

Do Not Smoke

Finally, we recommend that you do not smoke inside your recreational vehicle. In addition to causing damage to your recreational vehicle, tobacco smoke releases formaldehyde and other toxic chemicals.

Medical Advice

If you have any questions regarding the health effects of formaldehyde, please consult your doctor or local health department.

TABLE OF CONTENTS

A. WARRANTY AND SERVICE

Warranty

Warranty Explanation

Service

Reporting Safety Defects

Maintenance Schedule

Smoke/CO Alarm

LP Gas Detector

Overnight Stop

Extended Stay

Winter Traveling

Countertops

Vents

Interior Bulbs

G. PLUMBING

LP (Liquid Petroleum) Gas

Water System

Water Pump

City Water Hookup

Exterior Shower

Faucets

Drain Valve Locations

Toilet

Storage and Winterizing

Drainage/Waste System

Monitor System

TV Antenna

Entertainment Center

Satellite System

Solar Power

B. DRIVING

Loading

Weighing The Motorhome

Seat Belts

Trailer Towing & Driving Tips

Towing The Motorhome

Safety Check List

E. EXTERIOR

Cleaning Exterior

Roadside Exterior Features

Curbside Exterior Features

Awning

F. INTERIOR FURNISHINGS AND ACCESSORIES

Seats

Lounge/Bed, Dinette

Vinyl Floor

Cabinets

Wet bath

Galley/Lavatory Sinks

Interior Skin

Fabric

Shades

H. ELECTRICAL

120 Volt System

Energy Management System

GFI Breakers

Generator

12-volt Operation

Battery Disconnect

I. APPLIANCES

Air Conditioner

Furnace

Refrigerator

Cooktop

Microwave Oven

Water Heater

Coffee Maker

C. SPRINTER VAN

Component Identification

Tire/Wheels

Changing a Tire

Wheel Simulator

J. SPECIFICATIONS

Dimensions

Capacities

D. CAMPING

Safety

INDEX

WARRANTY AND SERVICE

AIRSTREAM MOTORHOME LIMITED WARRANTY

WARRANTY COVERAGE

Airstream Inc. (“Airstream”) warrants that it will repair or replace defects in material or workmanship in any components of a new Airstream motorhome purchased from an authorized Airstream dealer in the United States or Canada for 36,000 miles (57,937 Kilometers) or a period of thirty-six (36) months from the date the motorhome is first delivered to the original retail purchaser. In order to obtain coverage under this Limited Warranty, you must notify an authorized Airstream dealership or Airstream of the warrantable defect no later than ten (10) days following expiration of this Limited Warranty. Airstream’s obligation to repair or replace defective materials or workmanship is the sole obligation of Airstream under this Limited Warranty. Airstream reserves the right to use new or remanufactured parts of similar quality to complete any warranty work.

LIMITATION OF IMPLIED WARRANTIES

IMPLIED WARRANTIES ARISING UNDER APPLICABLE LAW, IF ANY, INCLUDING BUT NOT LIMITED TO IMPLIED WARRANTIES OF MERCHANTABILITY OR FITNESS FOR A PARTICULAR PURPOSE, ARE HEREBY LIMITED IN DURATION TO THE TERM OF THIS LIMITED WARRANTY. ALL OTHER WARRANTIES, EXPRESS OR IMPLIED, ARE HEREBY DISCLAIMED BY AIRSTREAM. SOME STATES DO NOT ALLOW LIMITATIONS ON HOW LONG AN IMPLIED WARRANTY LASTS, SO THE ABOVE LIMITATIONS MAY

NOT APPLY TO YOU.

WHAT IS NOT COVERED BY THIS LIMITED WARRANTY

This Limited Warranty does not provide coverage for any of the following:

1. Tires, batteries, stereo, television, range/stove, furnace, refrigerator, water heater, microwave, generator, slide-out mechanisms, and other materials, parts and components warranted by persons or entities other than Airstream. Please refer to the warranties of component manufacturers for terms and conditions of coverage;
2. Any part or component of the motorhome that was not manufactured or installed by Airstream;
3. Normal deterioration due to wear or exposure, including but not limited to rust, corrosion, oxidation, and cosmetic blemishes;
4. Normal maintenance and service items, including but not limited to light bulbs, fuses, lubricants, sealants and seals, slide out adjustments, door adjustments, and awning tension;
5. After-market equipment or accessories installed on the motorhome after completion of manufacture by Airstream, or any defects or damage caused by such items;
6. Motorhomes not purchased through an authorized dealer of Airstream motorhomes, and motorhomes purchased directly or indirectly through auction, salvage, repossession, or other non-customary sale means;



WARRANTY AND SERVICE

7. Defects or damage caused by, in whole or in part, or in any way related to:

- a. Accidents, misuse (including off-road use), or negligence.
- b. Failure to comply with the instructions set forth in any owner's manual provided with the motorhome.
- c. Alteration or modification of the motorhome except such alterations or modifications approved in writing by Airstream.
- d. Acts of God or other environmental conditions, such as lightning, hail, salt, or other chemicals in the atmosphere.
- e. De-icing agents or other chemicals applied to the motorhome.
- f. Failure to properly maintain or service the motorhome, including but not limited to the maintenance of lubricants, sealants, and seals.
- g. Condensation and the results of condensation including water damage and the growth of mold or mildew. Mold and mildew are natural growths given certain environmental conditions and are not covered by the terms of this Limited Warranty.
- h. Use of the motorhome other than for temporary recreation purposes, including but not limited to use of the motorhome for residential, commercial, disaster relief, or rental purposes.
- i. The addition of weight to the motorhome that causes the motorhome's total weight to exceed applicable motorhome weight ratings, or addition of weight causing improper distribution of the weight of the motorhome.

j. Failure to seek and obtain repairs in a timely manner.

k. Failure to use reasonable efforts to mitigate damage caused by defects.

l. Failure to properly ventilate the motorhome.

m. Improper electric power supply or improper vehicle hookup to other facilities.

n. Acts or omissions of any person or entity other than Airstream.

DISCLAIMER OF INCIDENTAL AND CONSEQUENTIAL DAMAGES

Airstream hereby disclaims any and all incidental and consequential damages arising out of or relating to the motorhome, including expenses such as transportation to and from vehicle dealerships and Airstream repair facilities, loss of time, loss of pay, loss of use, inconvenience, commercial loss (including lost profits), towing charges, bus fares, vehicle rental, service call charges, gasoline expenses, incidental charges such as telephone calls and facsimile transmissions, and expenses for lodging. This disclaimer is independent of any failure of the essential purpose of any warranties provided with the motorhome, and shall survive any determination that a warranty failed of its essential purpose. Some states do not allow the exclusion or limitation of incidental or consequential damages, so the above limitation or exclusion may not apply to you.

OBTAINING WARRANTY SERVICE

In order to obtain warranty service under this Limited Warranty, the owner must

WARRANTY AND SERVICE

do all of the following:

1. Owner and dealer representative must complete, sign, and return the Customer Performance Checkout within 10 days from delivery of the motorhome;
2. Notify Airstream or one of its authorized, independent dealers, of any claimed defect within the warranty period or 10 days thereafter;
3. Provide notification of a defect within 10 days of discovery of that defect; and
4. Promptly return the motorhome to an authorized Airstream dealer or Airstream for repairs.

If you believe a defect covered by this Limited Warranty still exists after an attempted repair by an authorized Airstream dealer, you must contact Airstream at the following address, specifying:

1. The complete serial number of the motorhome;
2. The date of original purchase and the date of original delivery;
3. The name of the selling dealer; and
4. The nature of the problem and the steps or service which have been performed.

AIRSTREAM, INC. 419 West Pike Street P.O. Box 629 Jackson Center, Ohio 45334-0629 Attention: Owner Relations Department

Airstream may direct you to an authorized Airstream dealer, or may request that you bring your motorhome to the Airstream factory in Jackson Center, Ohio for repairs.

Airstream does not control the scheduling of repairs at its authorized Airstream dealers, and repairs at the Airstream factory may not be immediately available. Therefore, you may encounter delays in scheduling repairs and/or completion of repairs. All costs associated with transporting the motorhome for any warranty service shall be the sole responsibility of the owner.

DEALER REPRESENTATIONS EXCLUDED

The entire Limited Warranty provided by Airstream is set forth herein. Airstream will not be responsible for any additional representations or warranties made by any person or entity other than Airstream, and Airstream's obligations are solely as set forth in the terms and conditions of this Limited Warranty.

WARRANTY TRANSFER

This Limited Warranty is transferable to subsequent owners for the remaining duration of the warranty period, upon approval from Airstream. Transfer of this Limited Warranty will only be approved by Airstream upon all of the following: (1) Airstream's receipt of a completed transfer application form; (2) the payment of a \$250.00 processing fee to Airstream; and (3) the completion of an inspection of the condition of the motorhome, at the owner's expense, by an



WARRANTY AND SERVICE

authorized Airstream dealer in accordance with Airstream's required procedure and Airstream's receipt of a written report as to the results of such inspection.

Transfer application forms are available from your dealer or Airstream's Service Administration Department.

CHANGES IN DESIGN

Airstream reserves the right to make changes in design and improvements upon its products from time-to-time, without imposing upon itself any obligation to install additional features in your motorhome.

CONSUMER ARBITRATION PROGRAM

Airstream Inc. participates in the Consumer Arbitration Program for Recreation Vehicles (CAP-RV). This third-party dispute resolution program is available, at no charge to you, to settle unresolved warranty disputes for recreation vehicles. This dispute resolution program reviews eligible product and service related complaints involving warranty covered components.

To find out more about this program, or to request an application/brochure, please call the Arbitration Administration office toll-free 800.279.5343.

For recreation vehicles purchased in the State of California: The CAP-RV program operates as a certified mechanism under the review of the California Arbitration Certification Program. You must utilize the arbitration program be-

fore claiming rights conferred by 15 USC section 2310 (Uniform Commercial Code) or Civil Code section 1793.22(b) (Song-Beverly Warranty Act). You are not required to use the program if you choose to seek redress by pursuing rights and remedies not created by those laws.

Members of the armed forces who purchased the vehicle in California, or who were stationed in or a resident of California at the time of purchase (regardless of state of purchase) or who are stationed in California at the time of application to this program may utilize the CAP-RV program.

THIS WARRANTY GIVES YOU SPECIFIC LEGAL RIGHTS, AND YOU MAY ALSO HAVE OTHER RIGHTS WHICH VARY FROM STATE TO STATE.

AIRSTREAM, INC.
419 West Pike Street
P.O. Box 629
Jackson Center, OH 45334-0629
Tele: 937-596-6111
Fax: 937-596-6539

WARRANTY AND SERVICE

WARRANTY EXPLANATION

Along with your new Airstream motorhome, you have purchased the Airstream Limited Warranty. Read your Limited Warranty carefully. It contains the entire agreement with respect to Airstream's obligation on the Limited Warranty on your new vehicle. The terms of the Limited Warranty, and only those terms, will define Airstream's responsibility. When you receive your Limited Warranty file it for safekeeping.

Upon proof of purchase date to any Airstream Dealer Service Center, defects in materials or workmanship will be repaired or replaced without cost to the owner for a period of thirty six (36) months from the original purchase date, or 36,000 miles (57,937 kilometers), whichever occurs first. Written warranties of some manufacturers of components of the motorhome will be honored by Airstream for the duration on that manufacturer's warranty.

The Airstream Limited Warranty Excludes:

Normal Wear:

Items such as curtains, upholstery, floor coverings, window and vent seals may show wear within the three year/36000 mile Limited Warranty period depending upon the amount of usage, weather, and atmospheric conditions.

Accident

Damage caused by accident is usually visible, and we strongly urge our dealers and customers to inspect the motorhome upon delivery for any damage caused by accident while being delivered to the dealer, or while it is on the dealer's lot. Damage of this nature becomes the dealer's or your responsibility upon acceptance of the motorhome. GLASS BREAKAGE, whether obviously struck or mysterious, is always accidental and covered by most insurance policies.

Abuse

Lack of customer care and/or improper maintenance, including failure to comply with the instructions and terms of the all owner's manuals and booklets, or failure to heed proper vehicle operation shown by the dash instruments is not covered by warranty.

Exposure

Deterioration by sunlight is possible to such items as tires, curtains or upholstery. Steel or metal surfaces are subject to the elements, causing rust and corrosion that is normal and beyond the control and responsibility of Airstream.



WARRANTY AND SERVICE

Appearance

 Paint and appearance items that show imperfections, damage to interior and exterior surfaces resulting from abrasion, collision or impact, and broken window glass is not covered by the Airstream Limited Warranty and should be brought to the attention of your Airstream dealer at the time of delivery and during pre-delivery inspection.

Overload

Overload Damage due to loading beyond capacity or to cause improper balance is not covered by the Airstream Limited Warranty. The Airstream motorhome is engineered to properly handle any normal load. There are limits to the amount of load that can be safely transported depending upon speed and road conditions. If these limits have been exceeded, the Airstream Limited Warranty will not cover resulting damage. For additional information on the load capacity of your motorhome, consult your Sprinter and Airstream Owner's Manuals or gross vehicle weight rating plate.

Chemical Gassing

Chemical gassing is not a "Defect" in your recreational vehicle and is not covered by the Limited Warranty. Please follow the recommendations in this

manual Introduction section to address this concern.

Sprinter Van

Airstream, Inc., does not accept any responsibility in connection with any of its motorhomes for the Sprinter Van or its components. The Sprinter Van and its components are covered by Sprinter Warranties as explained by Sprinter literature provided with each motorhome. Your Sprinter Van and its components are pre-checked by its manufacturer before delivery to Airstream. All service to the Sprinter Van and its components must be performed by Sprinter designated service points according to the manufacturer's warranty and service policies. Sprinter Literature is supplied with each Airstream motorhome. The literature gives important information concerning its warranty coverage, maintenance, and operation.



WARNING: Your Sprinter Van Operator's and Warranty Manuals contain important cautions, warnings, operational, and warranty information on the Sprinter and its components. All information in the Sprinter manual should be reviewed and followed for your safety.

The Airstream Interstate Owner's Manual may provide addition information and tips on the use of the Van as a motorhome, however, no information, in whole

WARRANTY AND SERVICE

or in part, in any Airstream manuals should be interpreted as advice or directions to disregard or void the Warnings, Cautions, Notices, or other information contained in the Sprinter's manuals.

Other Exclusions

Tires, batteries, and the generator are serviced by their respective manufacturers and will be handled by their service centers according to the terms of their written policy. Any warranty forms from these manufacturers should be completed promptly, preferably at time of purchase.

Service

Before leaving the factory, each and every vital part of the motorhome is tested for performance. Each test is signed and certified by an inspector. After the motorhome arrives on your dealer's lot all of these vital parts and systems are again tested. When you take delivery of your new motorhome you will receive a complete Customer Performance Checkout.

Major service under your Airstream Limited Warranty is available through our nationwide network of Airstream Dealer Service Centers. An up-to-date list of Dealer Service Centers has been provided with your new motorhome. This list is current as of the date of publication. Please contact an authorized Airstream

dealer if you need service.

Occasionally dealerships change, or new dealers are added who may not appear on this list. For this reason, it is suggested that you contact your selling dealer from time to time and bring your list up to date or go to www.airstream.com and use the dealer locator. Airstream customer relations can also supply you with an up to date list.

ALL SERVICE CENTERS OPERATE ON AN APPOINTMENT BASIS FOR THE UTMOST EFFICIENCY.

When you require service from the Airstream Factory Service Center or a Certified Dealer Service Center, please contact the service manager for an appointment, and kindly inform him if you are unable to keep the appointment date or wish to change it. Service may be arranged at the Airstream Factory Service Center by contacting the Service Coordinator at:

Airstream Factory Service Center
P.O. Box 629
419 W. Pike Street
Jackson Center, Ohio 45334-0629
Phone: 937-596-6111 Fax: 937-596-6802



WARRANTY AND SERVICE

REPORTING SAFETY DEFECTS



If you believe that your vehicle has a defect which could cause a crash or could cause injury or death, you should immediately inform the National Highway Traffic Safety Administration (NHTSA) in addition to notifying Airstream Inc..

If NHTSA receives similar complaints, it may open an investigation, and if it finds that a safety defect exists in a group of vehicles, it may order a recall and remedy campaign. However, NHTSA cannot become involved in individual problems between you, your dealer, or Airstream Inc.

To contact NHTSA, you may either call the Vehicle Safety Hotline toll-free at 1-888-327-4236 (TTY: 1-800-424-9153); go to <http://www.safercar.gov>; or write to: Administrator, NHTSA, 1200 New Jersey Avenue, S.E., Washington, DC 20590.

You can also obtain other information about motor vehicle safety from <http://www.safercar.gov>.

WARRANTY AND SERVICE

MAINTENANCE SCHEDULE



WARNING: FAILURE TO MAINTAIN YOUR COACH CAN CAUSE PREMATURE AND UNEXPECTED PARTS BREAKAGE AND/OR ERRATIC OPERATION THAT MAY BE HAZARDOUS. SERIOUS INJURY COULD RESULT FROM FAILURE TO HEED THIS WARNING.

EVERY 1,000 MILES OR 60 DAYS

Smoke/CO Alarm	Test weekly and replace battery as required.
GFI Circuit Breaker	Test and record.

EVERY 5,000 MILES OR 90 DAYS

LPG Regulator	Check bottom vent for obstructions
Roof Vent	Lubricate with light household oil
Living Area Windows	Lubricate with light household oil

EVERY 10, 000 MILES OR 6 MONTHS

Smoke/CO Alarm	Vacuum exterior only.
----------------	-----------------------

EVERY 12,000 MILES OR 1 YEAR

LP Tank	Check for damage.
Sealer	Check and reseal, windows, lights, and vents. Reseal with urethane sealant or equivalent as needed.

APPLIANCES

Appliances have maintenance schedules and advice in their respective Owners/Operation Manuals. These manuals are included in the owner's packet given to you by your dealer. Please become familiar with and follow all information in these manuals.

AUTOMOTIVE

See the Sprinter Operators Manual and Maintenance Logbook for Automotive Maintenance schedules and pre-trip inspections.



WARRANTY AND SERVICE

MAINTENANCE RECORDS



DATE	DEALER	SERVICE PERFORMED

DATE	DEALER	SERVICE PERFORMED

LOADING

One of the most critical aspects of safely operating a motorhome is knowing the weights involved and where they are placed. The first thing to determine is how much cargo is being loaded and confirming that it is within the capacities of the equipment being used. Determining WHERE that load is placed is critical to the way your rig will handle on the road.

Do not try to guess what your recreational vehicle weighs loaded. Load your RV including water, propane, etc and take it to a public scales. Weigh each axle of your vehicle. Refer to your axle weight and tire limits to see if your within a safe range. Total all axle weights and make sure you are below the GVWR. If you are not overloaded make sure your load is balanced. Do not load too much on one side. A balanced load is much easier to tow or drive.

Front to back balance is also important. Step back and look at your recreational vehicle. Make sure that there is not too much weight on the hitch or on the rear of the RV. Be sure to secure all items. Loose items can cause damage and be a safety issue if not properly secured.

The Cargo Carrying capacity tag shown below is installed on every motorhome and can be found on the inside of the screen door on your vehicle.

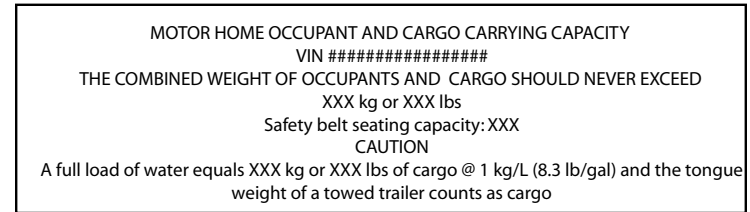

To arrive at the “THE COMBINED WEIGHT OF OCCUPANTS AND CARGO SHOULD NEVER EXCEED” number, Airstream weighs the vehicle as finished and adds the weight of full tanks of liquid propane and chassis fuel. That number is subtracted from the Gross Vehicle Weight Rating (GVWR) of the motorhome and listed on the tag, The total weight of any and all cargo, including but not limited to dealer or customer modifications or additions, fluids (freshwater, holding, and water heater tanks), food, clothes, tools, the tongue weight of a towed trailer or vehicle, and passengers should never exceed the number listed while the motorhome is in transit.

The “Safety belt seating capacity” is the number of passengers that seat belts are provided for.

The “A full load of water equals” number is arrived at by multiplying the fresh



DRIVING

water tank and water heater capacities by 1Kg/L or 8.3 lb/gl.

When loading the vehicle it is important to keep the Gross Vehicle Weight Rating, Gross Axle Weight Ratings, Tire Weight Ratings (listed on the vehicle Tire Information Placard), and the Cargo and Occupant Capacity in mind and not to exceed these specifications. Your safety depends on not overloading the motorhome, motor home axles, and tires. See the specification section for the weight rating list of these items.

WEIGHING

To determine the actual weight of your vehicle with personal cargo and water it must be weighed on scales as you plan to travel. The most common scales are those used by states to weigh trucks used along the highway. In rural areas, grain elevators and cement outlets are a good source and another would be a gravel pit. Note: Weighing instructions for this motorhome is explained on the next page. If you have trouble locating scales, a call to your State Highway Patrol will usually find them very cooperative in assisting you.

Vehicle and Trailer Weights and Ratings Definitions

- Gross Vehicle Weight Rating (**GVWR**) is the maximum permissible weight of the motorhome.
- Gross Vehicle Weight (**GVW**): comprises weight of vehicle including

tools, spare tire, installed accessories, passengers, cargo, and trailer tongue weight. It must never exceed the GVWR.

- Gross Axle Weight Rating (**GAWR**) is a maximum permissible axle weight.
- Gross Trailer Weight (**GTW**) is a maximum permissible trailer weight to be towed.
- Trailer Tongue Weight Rating (**TWR**) is the maximum permissible weight of the trailer tongue. This counts as cargo when loading a motorhome.

NOTE: Check the Sprinter manual for all weights and the tire information placard location.

Procedure for Weighing A RV (See chart on next page).

Vehicle should be weigh loaded as you normally travel.

1. Fill in first row from Specification Section of this manual.
2. Weigh vehicle as shown in row 2 (Scale Weight) and fill in blanks.
3. Weigh one side of vehicle as shown In Individual Wheel Position Weight.
4. Calculate other side as shown in last row.

Information for line 1 is located in the specification section in this manual.

NOTE: Check the Sprinter manual for all weights and tire information placard location.

Front Axle GAWR	GVWR	Rear Axle GAWR	GCWR - GVW
SCALE WEIGHT		Optional Tow Weight	
STEP 1 Front Axle GAW	STEP 2 GVW	STEP 3 Rear Axle GAW	STEP 3a Tow Weight minus Weight of Trailer or Vehicle Towed
INDIVIDUAL WHEEL POSITION WEIGHT			
STEP 4 Left Front Wheel Position	STEP 5 Left Side (Total LF + LR)	STEP 6 Left Rear Wheel Position	
Calculated	Calculated	Calculated	
Right Front Wheel Position Step 1 minus Step 4	Right Front (Total RF + RR) Step 2 minus Step 5	Right Rear Wheel Position Step 3 minus Step 6	

GAWR = Gross Axle Weight Rating

GVWR = Gross Vehicle Weight Rating

GCWR = Gross Combination Weight Rating

DRIVING

WEIGHT DISTRIBUTION

Motorhomes have fresh water and wastewater tanks, a water heater, and storage areas. It gives you great flexibility in loading. With flexibility comes responsibility. If you want to load down all the storage compartments, the amount of fluids may have to be reduced. It's a trade off so plan wisely. Distribute your additional cargo as evenly as possible with the heaviest objects located as low as possible.

Do you really want to carry a full freshwater tank to a RV park 1,000 miles away and then hook up to a city water supply? Even if you're going to the "boondocks", you can usually fill your water tank shortly before entering the area. Just reducing your load by 10 gallons of water lets you carry an additional 30 pounds of cargo.

SAFETY

SEAT BELTS

Federally approved seat belts are provided for the use of the driver, the right front passenger, the second row captains chairs, and the rear lounge. Most states require by law that all passengers in a motor vehicle use seat belts while in transit. It is strongly recommended that all occupants remain seated with their safety belts firmly attached while the motorhome is in transit. The driver should adjust his seat so that he is able to reach all controls easily with the belt on, and be able to use all the travel on the foot brake. Seat belts should be placed as low as possible around the hips to prevent sliding out from under them in case of accident. This places the load of the body on the strong hipbone structure instead of around the soft abdominal area. Remember one occupant per seat belt when traveling.

The driver and front passenger seat belt buckle operation and is explained in the Sprinter manual.

The rear lounge and rear captain chairs seat belt buckles are secured by inserting the male end into the female buckle until the buckles are secured. To release the buckle press the

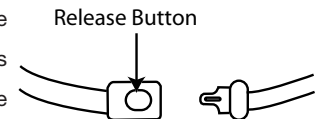

release button on the female end.



WARNING: Become familiar with and follow all directions, advice, and warnings pertaining to seats, seat belt operation, and restraint systems, provided in the Sprinter Operator's Manual. Do not allow passengers to ride anywhere in the motorhome except in seats that are equipped with approved seat belts.



WARNING: Children must be secured in a Federally Approved Child Restraint Device. Failure to use proper restraints while in transit can result in severe or fatal injuries. Never place an infant seat that faces to the rear on the front passenger seat. Never place an unbelted infant seat on any seat while in transit.

Child restraint devices are designed to be secured with lap or lap/shoulder belts. All instructions supplied by the restraint manufacturer must be followed. Statistics have shown children are safer when properly restrained in a rear seating position than in a front seating position.

Often the children traveling in motorhomes are grandchildren. There are times when our love for grandchildren makes us hesitate to properly supervise their actions. Don't hesitate when it comes to passenger safety. Make sure all passengers are properly restrained.

CHILDREN HAVE LOVED ONES TOO.

IF YOU WON'T BUCKLE UP FOR YOURSELF, BUCKLE UP FOR THEM.



DANGER: Drinking or taking drugs and driving is a very dangerous combination. Even a small amount of alcohol or drugs can affect your reflexes, perception, and judgment. The possibility of a serious or even fatal accident is sharply increased when you drink or take drugs and drive. Never drink and/or take drugs and drive or allow anyone to drive after drinking and/or taking drugs.

DRIVING

TRAILER TOWING AND DRIVING TIPS

(Some text is partial excerpts from Sprinter Operators Manual)



WARNING: Failure to use proper equipment and driving technique can result in a loss of vehicle control when towing a trailer. Improper towing or failure to follow the instructions contained in this section can result in serious injury. Follow the guidelines below carefully to assure safe trailer operation. Ask your authorized Sprinter or Airstream dealer if you require an explanation of information contained in the manuals.

Trailer Hitches

Units have hitches and wiring installed from the Sprinter manufacturer. The Sprinter 7- way connector is used for lights and charge line on a trailer. For further information, please see your authorized Sprinter dealer.

The bumpers on your vehicle are not designed for use with clamp type hitches. Do not attach rental hitches or other bumper type hitches to them.

To reduce the possibility of damage, remove the hitch ball adapter from the receiver when not in use.

Since this vehicle is designed and intended primarily as a load-carrying vehicle,

towing a trailer will affect handling, durability and economy. Maximum safety and satisfaction depends upon proper use of correct equipment and avoiding overloads and other abusive operation.



WARNING: The total weight of the motorhome and trailer must not exceed the GCWR listed in the specification section of this manual. The maximum towing capacity varies according to the size of the motorhome and its GCWR. Vehicles should be properly equipped for towing trailers. Information on trailer hauling capabilities and special equipment required may be obtained from your Sprinter and/or Airstream dealer.

Loading a Trailer

When loading a trailer, you should observe that neither the permissible GTW (Gross Tongue Weight), nor the trailer GVWR are exceeded.

Maximum permissible values are listed on the safety compliance certification labels for the vehicle and for the trailer to be towed. For their location, see the Sprinter Operators Manual. The lowest value listed must be selected when determining how the vehicle and trailer are loaded.

To assist in attaining good handling of the vehicle/trailer combination it is important that the tongue weight be maintained at approximately 10%-15% of

the loaded trailer weight, but not to exceed the hitch rating. Tongue loads can be adjusted by proper distribution of the load in the trailer, and can be checked by weighing separately the loaded trailer and then the tongue.

The tongue weight (TW) at the hitch ball must be added to the GVW to prevent exceeding your Sprinter towed vehicles or rear GAWR.

When towing trailers, motorhome tires should be inflated to the highest pressures shown on the Sprinter Tire Information Placard. See Sprinter Manual for its location. The Cargo Carrying Capacity (CCC) of this vehicle is reduced by the amount that equals the trailer tongue load on the trailer hitch.

Checking Weights of Vehicle and Trailer

To assure that the tow vehicle and trailer comply with the maximum permissible weight limits and to know the actual weights, have the loaded vehicle-trailer combination (tow vehicle including driver, passengers, and cargo and trailer fully loaded) weighed on a commercial scale as explained earlier in this section.

Also check the vehicles front and rear axle weights and tongue weight. The values as measured must not exceed the Sprinter weight ratings listed on vehicle information placards and in the Sprinter manual. These ratings are also listed in

the Specification section of this manual, page J-1. **NOTE:** Check the Sprinter manual for all weights and tire information placard locations.

Attaching a Trailer

Please observe maximum permitted trailer dimensions (weight and length).

Most states and all Canadian provinces require safety chains between your tow vehicle and trailer. The chains should be crisscrossed under the trailer tongue. It must be attached to the hitch receiver, and not to the vehicles bumper or axle. Be sure to leave enough slack in the chains to permit turning corners.

Most states and all Canadian provinces required a separate brake system for towing trailers.



WARNING: The towing vehicle's braking system is rated for operation at GVWR (GROSS VEHICLE WEIGHT RATING), NOT at the GCWR (GROSS COMBINED WEIGHT RATING). A separate functioning brake system is required for any towed vehicles or trailers weighing more than 1000 lbs. (450 kg) when fully loaded. NEVER exceed the GVWR (GROSS VEHICLE WEIGHT RATING), or the GAWR (GROSS AXLE WEIGHT RATING) specified on a motorhome certification label. Also NEVER, exceed the

DRIVING

weight ratings of trailer hitch installed on a motorhome. Failure to heed any part of this warning could result in loss of control of the motorhome and towed vehicle or trailer and may cause an accident and serious injury. For specified towed vehicle braking requirements, consult the Sprinter Operator's manual that comes with this vehicle.



WARNING: Do not connect a trailer brake system (if trailer is so equipped) directly to the vehicles hydraulic brake system if your vehicle is equipped with antilock brakes. If you do, neither the vehicles brakes nor the trailers brakes will function properly. Property damage, injury or death to you or others may be the result.

The provided vehicle electrical wiring harness for a trailer towing has a brake signal wire for hookup to a brake controller. Most states and all Canadian provinces require a brake away switch on trailers with a separate brake system. The switch activates the trailer brakes in the possible event that the trailer might separate from the tow vehicle. Please consider using a trailer sway control system. For further information, see your authorized Sprinter or Airstream dealer.

Towing a Trailer

There are many different laws, including speed limit restrictions, having to do

with trailer towing. Make sure that your vehicle -- trailer combination will be legal; not only for where you reside, but also for where you'll be driving. A good source for this information can be the State Attorney General, State Police, or local authorities.

Before you start driving with a trailer, check the trailer's hitch, brake away switch, safety chains, electrical connections, lighting and tires. Also, adjust the mirrors to permit unobstructed view beyond rear of trailer.

If the trailer has brakes using an electric brake controller, start your vehicle and trailer moving slowly, and then apply the brakes manually using the brake controller to be sure the brakes are working properly. Read and follow the controller manufacturers recommendations.

When towing a trailer, check occasionally to be sure that the load is secure, and that lighting and trailer brakes (if so equipped) are functioning properly. Always secure items in the trailer to prevent load shifts while driving.

Take into consideration that when towing a trailer, the handling characteristics are different and less stable from those when operating the vehicle without a trailer. It is important to avoid sudden maneuvers.

The vehicle and trailer combination is heavier, and therefore is limited in ac-

celeration ability, and requires longer stopping distances. It is more prone to reacting to side wind gusts, and requires more sensitive steering input.

In order to gain skill and an understanding of the vehicles behavior, you should practice turning, stopping and backing up in an area which is free from traffic.

If possible, do not brake abruptly, but rather engage the brake slightly at first to permit trailer to activate its brake. Then increase the braking force.

We want every owner to be a safe and courteous driver. A few hours of towing practice in a large empty supermarket lot will make pulling your trailer over the road much easier. Line out two corners for left and right turns. You may also use these corners to practice backing and parking.

DURING PRACTICE OBSERVE THAT THE TRACKS MADE BY THE TRAILER WHEELS ARE DISTINCTLY DIFFERENT FROM THOSE MADE BY THE TOW VEHICLE.

Studying this will make it easier for you to correct mistakes. Consider truck or trailer type fender or door grip rear view mirrors for maximum visibility. In most states the law requires them.

After thoroughly inspecting your hitch, brakes, and tires you should be ready to

tow. Check traffic, signal that you are about to pull away, and start slowly. Look often in your mirrors, and observe the action of the trailer, then carefully move into the proper lane of traffic. Remember that the trailer wheels will not follow the path of the tow vehicle wheels; therefore, **WIDER TURNS ARE NECESSARY WHEN TURNING TO THE LEFT OR TO THE RIGHT.**

ON FREEWAYS OR EXPRESSWAYS try to pick the lane you want and stay in it. Always maintain plenty of space between you and the car ahead, at least the length of the tow vehicle plus trailer for every ten miles per hour. Remember that in order to pass another vehicle you will need longer to accelerate. You must also allow for the length of the trailer when returning to the right hand lane.

DRIVING

Tracking

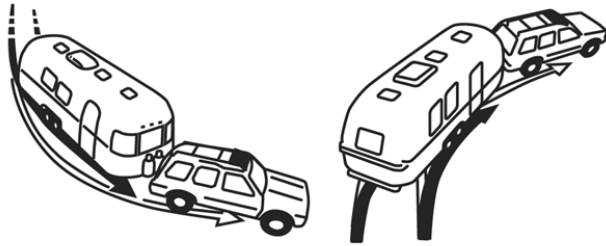

On a two-lane road cars may be lining up behind you because you are traveling at a lower speed. It is both courteous and sensible to signal and pull over at the earliest safe opportunity, and let them pass.

The BRAKE CONTROLLER (if so equipped) is activated when you apply the brakes of the tow vehicle. Your tow vehicle brakes will automatically apply the trailer brakes first when properly adjusted. This will help keep your tow vehicle and trailer in a straight line and make you stop as if you were driving the tow vehicle alone. If swaying or swerving should occur, briefly operating the controller separate from the vehicle brakes may help correct the situation. Practice this maneuver on a clear highway. Don't wait for an emergency then grope for the controller.

When trailering you might encounter a temporary cooling system overload during severe conditions such as hot days when pulling on a long uphill grade, when slowing down after higher speed driving, or driving long idle periods in traffic jams. If the hot indicator light comes on, or the temperature gauge indicates overheating and you have your air conditioner turned on, turn it off. Pull over in a safe place and put on your emergency brake. Don't turn off the engine. Increase the engine idle speed. Lift the engine hood and check for fluid leaks at the radiator overflow outlet. Check to see that all drive belts are intact and the fan is turning. If you have a problem have it fixed at the next opportunity. If there is no problem the light should go off or temperature should come down within one minute. Proceed on the highway a little slower. Ten minutes later resume normal driving.



DANGER: Never open a radiator cap when the tow vehicle is hot. Add coolant when the vehicle is cool.

When going downhill in dry weather, down shift so that engine compression will slow the whole rig down. Take dips and depressions in the road slowly and do not resume normal driving speeds until you are sure that the trailer wheels are clear of the dip.



WARNING: On slippery pavement do not use engine drag to help slow down as this may cause the rear wheels of the tow vehicle to

skid. On icy pavement drive slowly and if you feel the tow vehicle skidding gently apply the trailer brakes only. This will bring the tow vehicle and trailer back into a single line. Chains do not help trailer wheels.

When driving in mud and sand let the momentum carry the rig through. Apply power gently and use as little as possible. Stay in the tracks of the vehicle ahead and keep the tow vehicle in the highest possible gear. If you are stuck it is best to tow out the entire rig together without unhitching.

Despite the best hitch you will notice that whenever a large bus or truck overtakes your rig the displaced air first pushes the trailer rear slightly to the right and then affects the front. It may be necessary to steer very slightly, momentarily, toward the bus or truck to help compensate for the sway induced by the passing-vehicle. Do not apply the vehicle brakes, as this can tend to exaggerate the situation. You may find, however, that briefly applying the trailer brakes with your manual control will help eliminate sway.



WARNING: CHOCK THE TRAILER WHEELS when stopping on a hill or slope. Leaving your tow vehicle in gear is not enough for standstill safety. Do not use trailer brakes as parking brakes.

DRIVING

Backing Up

In BACKING UP the important thing to remember is to DO EVERYTHING SLOWLY and to correct immediately if you see the trailer turning the wrong way. Concentrate on the rear of the trailer. With your tow vehicle and trailer in a straight line, back up slowly and turn the bottom of the steering wheel in the direction you want the trailer to go. Watch out the window or in the mirror until the rear of the trailer is pointing in the desired direction. Your tow vehicle will be following the trailer in an arc. Straighten the tow vehicle and trailer by turning the steering wheel more sharply, and then when they are in line, straighten the steering wheel.

ALWAYS TRY TO BACK TO YOUR LEFT BECAUSE THE VISIBILITY IS MUCH BETTER. When you don't make it on the first try it is usually much easier to pull forward to your original straight position and start over.

If your spouse or traveling companion normally directs you when backing they should position themselves forward of the tow vehicle so the driver can easily see them. Their directions should always indicate to the driver the direction the rear of the

trailer should go. A little practice in a parking lot with the person giving directions can save a lot of frustration when backing into a campsite.



WARNING: take into consideration that when towing a trailer, the handling characteristics are different and less stable from those with operating the vehicle without a trailer. It is important to avoid sudden maneuvers. Sudden maneuvers may lead to loss of control over the vehicle -- trailer combination.

BACKING UP

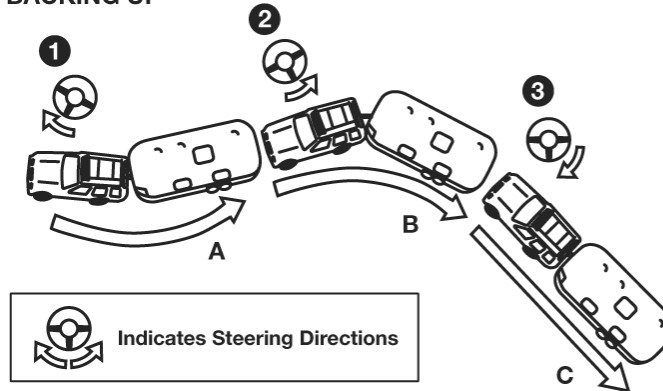

Position (A) start. Turn steering wheel as shown in (1) will put you in trailer Position (B). Turning steering wheel show in position (2) puts you in trailer position (C). Steering position (3) returns front wheels for straight backing.

NOTICE: If the transmission hunts between gears on inclines, manually shift to a lower gear. A lower gear and reduction of speed reduces the chances of engine overloading and/or overheating. When going down a long hill, shift into a lower gear and use the engines braking effect. Avoid riding the brakes, thus overheating the vehicle and trailer brakes. If the engine coolant rises to an extremely high temperature (coolant temperature needle approaching the red zone) when the air conditioner is on, turn off the air conditioner. Engine coolant heat can be additionally vented by opening the windows, switching the climate control fan speed to high and setting the temperature control to the maximum hot position.

Passing

Extreme care must be exercised when passing another vehicle. A vehicle with a trailer attached will require additional passing distance ahead then when driving without a trailer. Because your vehicle and trailer is longer then your vehicle alone, you will also need to go much further ahead of the passed vehicle before

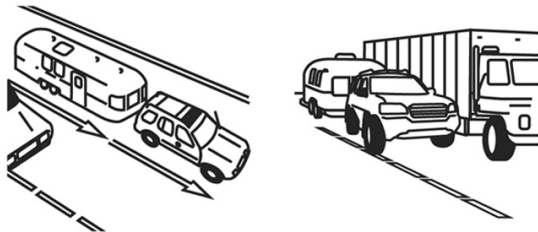

you can return to your lane.

Parking Your Motorhome



WARNING: to reduce the risk of personal injury, or damage to the vehicle power train, as a result of vehicle/trailer movement, always:

- **Keep right foot on the brake pedal.**
- **Shift gear selector lever to position "N".**
- **Have a second person place wheel chocks on downhill side of left and right trailer wheels.**
- **Slowly release brake pedal cannot vehicle and trailer roll into chocks until stopped.**
- **Firmly depress parking brake pedal.**
- **Move gear selector lever to position "P".**
- **On inclines, turn wheels towards the road curb.**

DRIVING

TOWING YOUR MOTORHOME

NOTICE: Considerable damage may occur if the motorhome is improperly lifted for towing purposes. Only qualified professional towing service companies with proper equipment should be used. Observe all cautions and warnings in the Sprinter Operator's manual before towing your motorhome.

NOTICE: Do not tow the vehicle if the key cannot be turned in the ignition lock.

If the key cannot be turned, the ignition lock remains locked and the vehicle cannot be steered. With the engine not running there is no power assistance for the braking and steering systems. In this case, it is important to keep in mind that a considerably higher degree of effort is necessary to brake and steer the vehicle. The vehicle must not be towed with the front axle raised and key in position two in the ignition lock as the drive wheels could then lock due to the acceleration skid control (ASR). See the Sprinter Operators Manual for information on the ASR.

NOTE: Sprinter recommends disconnecting the current to all chassis electric consumers using the Battery Isolator Switch if the vehicle sits for periods longer than 2 months. It is located to the right of the accelerator

pedal in the driver's foot well. Slide the red release down and pull it off the post. This will save jump starts, battery charge ups and possibly battery damage and replacement. The Sprinter manual describes its location, operation, and cautions in detail.

In addition Airstream recommends the house battery ground should also be disconnected during chassis electrical work. The battery box is located under the curbside rear lounge on the rear lounge model and under the roadside rear bed in the twin model model. A grounding stud is located inside the house battery box at the top. Battery ground wires are routed to this threaded stud. Remove the wires from the stud to break the ground circuit.

SAFETY CHECK LIST

Your Airstream motorhome should be given a thorough safety check before a trip. Regular use of the following list will provide safe operation of your motorhome and will help you spot any malfunctioning equipment and correct the problem as soon as possible. The list is to help you and may not be all-inclusive.



WARNING: Failure to heed the following items may cause damage to the vehicle or personal injury.

EXTERIOR CHECK LIST (BEFORE ENTERING VEHICLE)

1. Check condition of tires, keep tires at recommended inflation pressure per the tire and loading placard on the driver's door B-pillar.
2. Turn off Remote LPG valve switch.
3. Check that macerator hose, city water hookup, TV cable/satellite, and all exterior components are unhooked and properly stowed.
4. Check that all external compartments and filler openings are properly closed, latched, and/or locked.
5. Check that items stored on exterior of vehicle are securely tied down.
6. Would any items stored on exterior of vehicle present a clearance problem?
8. Follow all automotive manufacturers recommendations on checking and

filling fluid levels.

9. Check exterior lights and general condition of vehicle.

INTERIOR CHECK LIST (BEFORE DRIVING OFF)

1. It is important that all doors be completely closed and locked during travel.
2. Turn off living area water pump.
3. Check that refrigerator door is closed and latched if equipped.
4. Check that nothing heavy is stored in overhead or high cabinets, which could fall out and cause injury. Heavy items should be stored in lower cabinets.
5. Stow galley flip up shelf and pedestal tables.
6. Check that counter tops, range top, and shelves are clear of even small items that could become projectiles during an emergency braking or accident.
7. Retract and latch the wetbath wall.
8. Do not cook while unless motorhome is parked and stable. Hot food or liquid could scald due to a sudden stop or accident while traveling.
9. Be sure all LPG controls on the appliances are turned off.
10. Check that any internal stowage is securely held in place
11. Check that lights and switches are set in positions safe for travel.
12. Adjust the driver's seat so that you can easily reach and operate all controls. Make sure seat is locked in position. Do not adjust driver's seat swivel or recline mechanisms while vehicle is moving. The seat could move

DRIVING

unexpectedly causing loss of control.

13. Check that all passengers have seat belts on properly.
14. The freedom of movement of the brake and accelerator pedals must not be impaired in any way.
15. Check rear view mirrors adjustment, inside and outside. Adjust window coverings if necessary for maximum visibility.
16. Secure children in a Federally Approved Child Restraint Device.

REAR VIEW CAMERA (option)

Rear view camera controls are on the add on rear view mirror/monitor. The camera turns on automatically when in reverse or can be turned on manually with the switch on the mirror/monitor to view in transit. Please disregard the Bluetooth Connected/Disconnected pop up message when the monitor turns on and the Bluetooth No Connection message whenever the monitor moves out of standby mode. They will go off after about 15 seconds. See monitor owner manual included in your Owner's Packet for operation and Bluetooth hook up information.

The Airstream Interstate Motorhome is integrated into a Sprinter Van designed and manufactured by Sprinter. Operation of the Sprinter, its engine, power train, and other related components are discussed in the Sprinter Owner's Manual and other literature provide by Sprinter. As a point of reference, those systems discussed in this literature are warranted by Sprinter or their suppliers.

IMPORTANT SPRINTER INFORMATION

Your Sprinter Van Operator's and Warranty Manuals contain important cautions, warnings, operational, and warranty information on the Sprinter and its components. All information in the Sprinter manual should be reviewed and followed for your safety. The Airstream Interstate Owner's Manual may provide addition information and tips on the use of the Van as a motorhome, however, no information in the Airstream manual should be interpreted as advice or directions to disregard or void the warnings, cautions, or other information contained in the Sprinter's manuals. IF YOU BELIEVE THERE IS A CONFLICT IN INFORMATION, WARNINGS, CAUTIONS, OR SAFETY RELATED INFORMATION BETWEEN THE SPRINTER AND AIRSTREAM MANUALS, PLEASE CONTACT THE AIRSTREAM CUSTOMER RELATIONS DEPARTMENT IMMEDIATELY TO RESOLVE THE CONFLICT.

Fuel

NOTICE: The Sprinter Owner's Manual contains important fuel requirement information on using Ultra-Low Sulfur Diesel, Bio fuels, and very low temperature operation. Please read, understand, and follow this information.

Component Identification

If repairs are needed, it may be difficult to determine which parts are the Sprinter's and which are Airstream's responsibility. The following partial lists show the major components of the van and the company responsible for their servicing.

Sprinter Van Serviced by Sprinter or its suppliers.

For assistance in locating a service center in the United States:

Customer Assistance Center

Three Mercedes Drive

Montvale, New Jersey 07645-0350

1-877-762-8267

See Sprinter Warranty Information Manual for complete instructions.

SPRINTER VAN

Engine	Exterior Automotive lights
Engine Battery	Power mirrors
Engine Cooling System	Fog lamps
Transmission	Chassis Suspension
Brakes	Drive Axle and Hubs
Steering Assembly, Steering Wheel	Rear window defroster
Automotive Fuse Panel	Rear backup alarm
Wheels, Tires	Parking Brake
Alternator	Fuel Pump
Speed Control	Automotive electrical system
Instrument Panel Cluster	Hitch receiver and tow plug
Doors, cab, side and rear cargo	*Drivers/Passenger seats
Cab door windows and windshield	Radio/CD Player/Antenna
Dash AC/Heater/Defroster	Cargo door assist handle
12V Air compressor and puncture sealant	
Radio	

Driver's and Passenger's Seats and Restraint systems.

Sprinter provides the swivel pedestals and Airstream provides the seat decorative skirting and recovers the front seats to match the surrounding decor'.

Airstream Components serviced by Airstream Authorized Service Centers or Airstream suppliers.

Cab Area:

Driver's and passenger's seat skirting and covers.

Floor Mats

Optional Burlwood Dash Kit

Rear View Mirror/Monitor Option

Living Quarters:

Second row cab seats, swivels.

Interior furniture.

Privacy curtains.

Floor covering.

Appliances in the lounge/lavy area.

Fire extinguisher.

Smoke/CO detector

Window Coverings.

All plumbing systems.

Non-automotive electrical components including:

Monitor panel and its system

Inverter/Charger

Battery disconnect

120-volt system

12 Volt living area system

Roof AC

Generator and components.

House battery (optional 2)

Power vents

Sliding step

Living area entertainment center

Exterior

TV antenna	Exterior patio light
Wheel simulators	Radio antenna
Exterior body kit.	Awning
Power Step	
Exterior windows excluding windshield, drivers and passenger door	
Access doors and other living area electrical and plumbing components	

If you need further clarification or information, contact the Airstream Customer Relations Department at 937-596-6111 before contacting a service center for an appointment.

If you wish to write, the address is:

Airstream Inc.
Attn: Customer Service
419 W. Pike Street
P.O. Box 629
Jackson Center, Ohio 45334

TIRES

Don't let anyone tell you that under inflation or over inflation of tires is all right. It's not. If your tires don't have enough air (under inflation) you can get tire flexing, heat build-up, tire overloading, bad handling, bad fuel economy, and uneven wear. Too high an air pressure (over inflation) can result in abnormal wear, bad handling, harsh ride, and increase the chance of damage from road hazards.

Tire inflation pressures should be checked as per the Sprinter's Owner's manual and when significantly changing the load you plan to carry in your motorhome. Set the correct tire pressure before loading the vehicle. If the vehicle has been loaded, check the tire pressure and correct them if necessary. Always check tire inflation pressures when the tires are "cold".

Standard inflation pressures for tires are listed on a Tire Information Placard. Check the Sprinter manual for the placard location. Front and rear pressures are shown for each model and GVWR, and are based on the GVWR and front and rear axle ratings (GAWRs) printed on your vehicle VIN plate and Certification label. Tires must be inflated to these pressures when the vehicle is fully loaded or an axle GAWR is reached.

Proper FRONT END ALIGNMENT improves tire tread mileage. Your front-end



SPRINTER VAN

suspension parts should be inspected periodically and aligned when needed. Improper alignment may or may not cause the vehicle to vibrate. However, improper toe alignment will cause front tires to roll at an angle, which will result in faster tire wear. Incorrect caster or camber alignment will cause your front tires to wear unevenly and can cause the vehicle to “pull” to the left or right.



Vehicle Placard and Tire Inflation Pressure Label

The TIRE AND LOADING INFORMATION placard supplies information on the size and the cold tire inflation pressure for the original equipment tires supplied with your vehicle. Check the Sprinter manual for all weights and tire information placard location.

A MOTORHOME TIRE SAFETY ADDENDUM is included with your Airstream owner's packet. Please take the time to read, understand, and follow the information contained in the booklet.

PROPER TIRE INFLATION

The level of air in your tires affects your vehicle's overall performance. Not even the highest quality tire will perform well if it's not inflated properly. The correct pressure varies from vehicle to vehicle and depends in part upon driver preference. Each vehicle has a recommended inflation pressure, usually found

on a placard. Check the Sprinter manual for all weights and tire information and the placard location.

Correct tire inflation is a key component in tire care. The recommended inflation pressures for your tires are indicated on the certification label or in your owner's manual. Since RVs can be loaded with many different configurations, the load on each tire will vary. For this reason, air pressure should be checked based on the load on each individual tire. Cold Inflation Pressure should be adjusted to handle the maximum tire load, and all tires on the axle should carry the same inflation pressure. COLD TIRE INFLATION PRESSURE is the tire pressure checked in the morning before you drive more than a few miles or before rising ambient temperatures or the sun's radiant heat affects it. Check your tires' air pressures at least once a month, before each trip and each morning you drive during a trip. Tire pressure should be checked cold, as tire pressure ratings have been designed with typical running heat/pressure build-up in mind. Make sure the valves and caps are free of dirt and moisture.

Under Inflation

Under inflation brings a higher risk of susceptibility to damage due to road hazards, reduces tire casing durability, and causes a loss in fuel economy, plus uneven or irregular tire wear. Severe under inflation brings about an increased risk of tread separation, handling difficulties, and possibly tire failure, which is

caused by overheating.

IMPORTANT: It's a common practice for RV owners to lower tire pressure in their search for a smoother ride. This is not only dangerous, it's relatively ineffective, and the difference in ride quality is not significant. When minimum inflation pressure requirements are not met, tire durability and optimum operating conditions are compromised. Tire inflation pressure should always meet at least the minimum guidelines for vehicle weight.

- It may be necessary to inflate your tires at a truck stop or truck service center in order to achieve adequate air pressure for your coach's needs
- Only permanent air seal metal valve caps should be used.
- Be safe - if a tire has been run 20% under inflated, it must be dismantled and inspected by a trained professional. It should not be aired up without a full inspection or without using a safety cage. Use a calibrated gauge. If your tire is rated for higher inflation pressures, a special gauge will be required designed for larger tires.
- Don't bleed air from warm tires to reduce pressure buildup
- Don't inflate tires to cold PSI rating beyond rim specifications

HOW OVERLOADING AFFECTS YOUR TIRES

Tire pressure is what enables your RV tire to support loads. Overloading your tires can have serious consequences for passengers and your RV. Too much weight can cause stress on your RV's suspension system, brake failure, shock absorber damage, handling and steering problems, irregular tire wear and possible tire failure. Excessive loads or under inflation can lead to an excessive amount of heat and tire failure. If you discover that your tires cannot handle the load, lighten the weight of the load on your tires.

TIRES and WHEELS (partially excerpted from the Sprinter Van Operator's Manual)

Check tires regularly for even tread wear; tread depth (note legal requirements) and signs of external damage.

Use only wheels and tires of the same size, make and pattern.

Do not install tires that are not approved for the size and type of wheel installed on the vehicle itself. Only use those wheel sizes that were delivered to you by your authorized Sprinter dealer.

Use only wheels and tires that have been tested and approved by the vehicle

SPRINTER VAN

manufacturer.

Break in the tires at moderate speeds for distance of about 65 miles.



WARNING: always replace wheel nuts that are damaged or rusted. Never apply oil or grease to wheel nuts. Damaged wheel hub threads should be repaired immediately. Incorrect mounting bolts or improperly tightened mounting bolts can cause the wheel to come off. This could cause an accident. Be sure to use the correct mounting bolts. Checked tightness of wheel nuts regularly and retighten if necessary.

After changing a wheel, the wheel nuts must be tightened once the vehicle has been driven for about 30 miles.

If new or repainted wheels are fitted, the wheel nuts must be retighten again after about 600 to 3000 miles.



WARNING: Fitting wheel sizes other than those supplied by Sprinter to the vehicle will change the Sprinter's handling characteristics and may lead to an accident resulting in severe personal injuries, death and property damage.

Do not use remolded tires.

Tighten all wheel nuts evenly in the sequence indicated to **133 Lbf/ Ft. + or - 14 Lbf. /Ft** with a torque wrench..

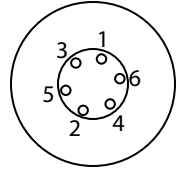

NOTE: Read the Sprinter manual for wheel torque and wheel tightening procedures.

Tire Grip

Tire grip is greatly reduced on a wet or icy road. Speed and driving style must therefore be adapted to suit road conditions. In winter, install M + S radial tires. Below a tread depth of 1/8 in., tire grip begins to decrease rapidly on wet roads.

Hydroplaning

Depending on the depth of the water layer on the road, hydroplaning may occur, even at low speeds and with new tires. Reduce vehicle speed, avoid grooves in the road, and apply brakes cautiously in the rain.

While we are on hydroplaning lets discuss driving in a flooded area. The majority of flood-related deaths are caused by people attempting to drive through

moving water.

Ironically, many drivers rescued from flood waters report that they were in a hurry to get home-- to safety -- as a reason for tempting the danger of driving into water. However it looks, and despite what car commercials depict, driving into flood waters may be the most dangerous things one might ever try considering the following:

Most cars will float (and be swept away) in 18-24 inches of moving water. Trucks and SUVs are not much better with only 6-12 more inches of clearance. Creeks and rivers can rise very rapidly and the road bottom can also wash away making the water much deeper than it appears.

Once cars are swept downstream they will often roll to one side or perhaps flip over entirely. The driver has a few precious seconds to escape the vehicle. In fact, many drivers panic as soon as the vehicle submerges and are found later with their seat belt intact.

Changing the Tire (partially excerpted from the Sprinter Van Operator's Manual)



WARNING: The Sprinter Operator's Manual contains important

cautions, warnings, specifications, and operational information on changing, maintaining, and replacing of the tires and wheels. Read, understand, and follow the Sprinter manual sections for changing a tire.



CAUTION: Changing a tire on a motorhome chassis is a physically demanding procedure. It requires specialized tools and knowledge of safety procedures. Only you can determine your knowledge base and physical ability. Don't take any unnecessary risks. You could turn an inconvenience into a tragedy. Please find a safe area to park your unit, call a tire service center and supply them with the information in the Sprinter Manual if you have any doubts about changing a tire.

Flat Tire

If you get a flat tire while driving, gradually decrease your speed. Hold the steering wheel firmly and slowly move to a safe place on the side of the road. The pressure of the spare wheel always has to be checked regularly (at least after every tenth time at the filling station).

The vehicle tool kit and the jack are located in a hatch under the front passenger foot well.

SPRINTER VAN



WARNING: The jack is designed exclusively for jacking up the vehicle at the jack take-up brackets built into either side of the vehicle. To help avoid personal injury, use the jack only to lift the vehicle during a wheel change. Never get beneath the vehicle while it is supported by the jack.

Precautions when changing a wheel:

- Keep hands and feet away from the area under the lifted vehicle.
- Always firmly set parking brake and block wheels before raising vehicle with jack.
- Do not disengage parking brake while vehicle is raised.
- Always use the jack on a level surface.
- Do not jack the vehicle up more than 1.2 inches between the tire and the surface. Otherwise, the vehicle may tip over and may cause serious injury or death to you or others.
- Be sure that the jack arm is fully seated in the jack take-up bracket.
- Always lower the vehicle onto sufficient capacity jack stands before working under the vehicle.
- Do not damage, grease, or oil wheel nuts or stud threads.

Procedure:

- Park the vehicle on a firm, level, non-slippery surface.
- Switch on the hazard warning flasher switch, apply the parking brake, and place the transmission selector in “P”.
- Everyone must leave the vehicle before you jack it up.
- Everyone must leave the danger zone, before jacking the vehicle. Danger zones vary with locations. Take a minute and look at what might happen if the vehicle falls off the jack and rolls. Set up your danger zone.
- The vehicle must be safeguarded in accordance with legal regulations (such as using a warning triangle).
- Prevent vehicle from rolling away by blocking wheels with wheel chocks (not supplied with vehicle) or sizable woodblocks or stone. On a level road place one chock in front of and one behind the wheel that is diagonally opposite to the wheel being changed. When changing a wheel on mild uphill or downhill grade, place chocks on the downhill side blocking both wheels of the other axle. **Do not jack vehicle up on a steep grade.**



WARNING: Do not change wheels on a steep uphill or downhill grade. The vehicle may begin to move and fall from the jack, which could cause property damage, personal injury and/or death.

Spare Tire Carrier

Airstream remounts the spare tire and installs the spare tire winch assembly. The spare tire is located under the rear of the motorhome against the bottom of the chassis floor structure .

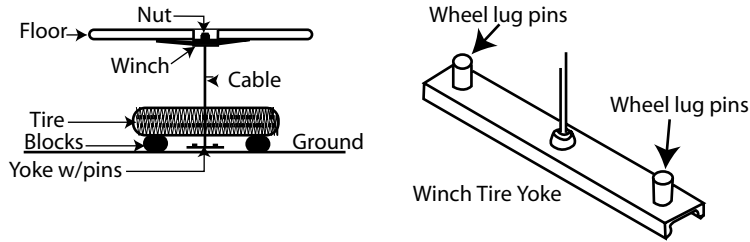

A winch mounted under the rear floor is used to lower and raise the spare tire. The winch has a nut sticking up through the floor under the center rear lounge on the rear lounge model accessed by opening the rear cargo doors. The nut is located inside the roadside bed on the twin bed model and is accessed by opening the bed storage door. To remove the spare tire, use the ratchet and a 19MM or 22MM deep well socket located in the tire replacement bag under the passenger side compartment floor to turn the winch nut counter clock wise. Place blocks under the tire before it reaches the ground to block the tire up and remove the weight from the yoke, then slide the yoke through the rim, and slide the tire from under the motorhome.

To store a spare tire reverse the removal instructions. The winch tire yoke has two pins that align with the wheel rim lug holes. The yoke pins must be placed in the lug holes to prevent the wheel assembly from sliding against the cable during transit and possibly cutting it. Be sure wheel is turned on the correct side so pins will fully engage the lug holes. The side of the rim that goes against the hub goes against the floor.

NOTICE: Spare tire carrier winch is designed for hand operation only. Do not use impact type power tools to drive this device.



WARNING: Defective spare tire equipment or an improperly stored spare tire could damage your equipment and/or cause serious, possible fatal injuries to people inside your motorhome, other motorists and pedestrians. The yoke pins must be inserted into the spare tire lug holes while wheel is in the store position during travel. The cable and support system must be free from defects and in good working order. The complete system should be checked before each trip and every 1000 miles during a trip for any signs of wear or possible failure. Please contact your dealer or Airstream Customer Service if you have any questions on the use of this equipment.

SPRINTER VAN

JACK

Read, understand, and follow the Sprinter operator's manual instructions, cautions, and warnings for changing a wheel and jack point locations.



WARNING: The jack is intended only for raising the vehicle briefly, for instance when changing a wheel. The jack must be placed on a firm, flat surface only. Do not change wheels on either uphill or downhill grades. Do not crawl under the vehicle while raised with jack. Do not start the engine while the vehicle is jacked up. Do not jack the vehicle up more than 1.2 inches between the tire and the surface. Otherwise, the vehicle may tip over and may cause serious injury or death to you or others. Jack stands must always be used while working beneath the vehicle. Failure to follow these precautions could result in property damage, personal injury and/or death.

The jack is located together with vehicle tool kit under the hatch in the front passenger foot well.

- Loosen the wheel nuts before raising the vehicle.
- Close the release valve on the jack.
- Assemble the pump lever provided and insert it into the socket on the jack.
- Secure lever by turning it clockwise in the socket.

- Position the jack under the appropriate jack point and raise the vehicle by pumping the lever.

WHEEL SIMULATORS

Front Wheel Simulators

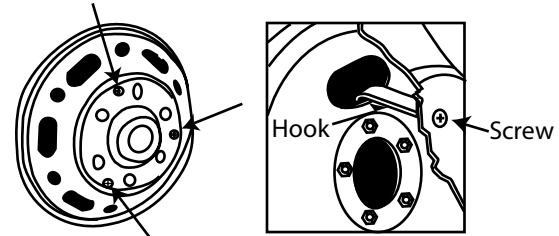

The wheel simulators are installed by Airstream.

Removing The Front Wheel Simulator: Loosen the 3 Phillips head screws until the hook mounts disengage from the rim oval hand holes.

Installing Front Wheel Simulator

Step 1: Line up the mounting hooks on the back of the wheel simulator with the oval hand holes of the wheel. **Note:** It is recommended not to use the oval hole by the valve stem for the mounting hooks. Then gently push the wheel simulator against the wheel until one of the hooks engage into one of the wheel

hand holes. Then continue one at a time engaging each hook into the other hand holes. **Note:** You may have to loosen the Phillips head screws a little before all the hooks will engage.

Step 2. Proper Engagement And Tightening

Make sure all the hooks have engaged into the proper hand holes of the wheel. Next, begin alternating tightening each Phillips head screw a few turns. **Very Important:** Look into the holes of the simulator where the hooks are and see that the hooks are engaged onto the center portion of the wheel oval hand holes. Next, carefully feel with your fingers through the holes in the simulator, to make sure the mounting hooks are fully engaged onto the center of the oval hand holes. As you continue alternating tightening each hook, keep your fingers in the oval holes of the simulator where you're tightening to make sure the hook stays engaged and in the center of the wheel oval hand holes.

Step 3. Verify Wheel Simulator Is Centered On Wheel

At this point stop alternating tightening the Phillips head screws, and check to see that the simulator is being tightened evenly all the way around the simulator and rim. Also check that the hand holes of the simulator align with the wheel hand holes. Slide your hands around the edge of the simulator and rim, making sure the simulator is evenly spaced all the way around the rim. If it's not even,

you may have to loosen the screws and readjust the simulator so that it is centered around the rim and the hand holes align, then repeat the tightening procedure in Step 2.

Step 4. Final Tightening Of Wheel Simulator

After final checking that the hooks are engaged into the center of the hand holes of the wheel and the simulator is evenly spaced and true all the way around the rim, then continue to alternate tightening the Phillips head screws until the simulator is securely tightened to the wheel.

Rear Wheel Simulators

The rear simulators have two brackets fastened to the axle cover plate by the axle nuts. The brackets each have one threaded hole. The simulator is fastened to the brackets by two Philip head screws.

To remove a rear simulator, loosen and remove the two screws.

To install a rear simulator:

Place wheel simulator onto the wheel making sure to line the holes in the simulator with the threaded holes of the mounting brackets. Then thread two



SPRINTER VAN

Phillips head screws through the simulator and into the threaded holes of the mounting brackets and tighten securely.

NOTICE: After reinstallation, the **WHEEL SIMULATOR** mounting system will seat itself into the wheel. After the first 100 miles check that the simulators are tight and secure to the wheels. If necessary, retighten the mounting screws. We recommend that the wheel simulators are checked and inspected periodically to make sure that they are tight and secure to the wheels.

Removing a Wheel

- Remove Wheel simulator if so equipped.
- Loosen the wheel nuts.
- Jack up the vehicle until the wheel is clear of the ground.
- Unscrew the wheel nuts and remove the wheel (keep the wheel nuts clean).

NOTE: If the vehicle moves forwards or backwards while it is being jacked up, lower it, stabilize the vehicle, and repositioned the jack. When the vehicle is jacked up, the jack must stand vertically (plumb-line).

INSTALLING A WHEEL

Mounting The New wheel

- Before fitting the spare wheel, clean rust and dirt off the contact surfaces of the wheel and the wheel hub, and from the wheel nuts.
- Note the specified wheel and tire size, tire load capacity and speed code.
- Do not change the tire's direction of rotation.
- Do not damage, grease, or oil wheel nuts or their threads.

Centering wheels with wheel nuts

- If dual assemblies are used, before placement, the inner wheel should be inspected to ensure that all ball bearing rings are in proper position.
- Install the wheel and snug the wheel nuts.
- Slightly tighten wheel nuts.

Lowering the Vehicle

- Slowly opened jack release valve to lower vehicle until tire is resting on ground.
- Tighten the wheel nuts in a crosswise pattern to the specified to work with a torque wrench. **For tire pressure & Wheel bolt torque procedures: See Sprinter Van Operator's Manual.**

- Remove jack and stow it in the vehicle tool kit.
- Check the tire pressure, for tire pressures see Sprinter operator's manual.
- Retighten the wheel nuts to the specified torque with a torque wrench after a distance of approximately 30 miles.



WARNING: Only certain tires meeting the tire size/load/speed index ratings contained in the Tire Pressure Tables, to be found from the Index Section of the Sprinter's Operators or Owners Manual, are certified to conform to FMVSS 120 for the Sprinter Vehicle at this time. Please check your sidewalls of your originally equipped tires for specific makes/sizes, and speed load ratings when you need to replace your tires. To prevent accident, injury or possible death, use only the correct tires for your tire replacement.

Wheel Bolt Tightening

IMPORTANT! Consult the Sprinter Operators manual for extensive wheel tightening and wheel torque procedures, cautions, and warnings.

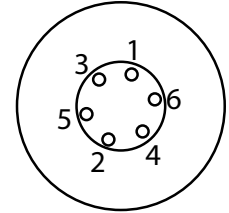

Tighten all wheel nuts evenly in the crosswise sequence indicated.



WARNING: For safety reasons, the wheel tightening torque must be checked immediately after changing a tire and again after 30 miles to 133 Lbf/ Ft. + or - 14 Lbf. /Ft. The wheels could otherwise come loose.

TIRE ROTATION

Front and rear tires perform different jobs and can wear differently depending on the types of roads driven, your driving habits, etc. To obtain the longest tire life you should INSPECT AND ROTATE your tires regularly.

Many automotive dealers and tire dealers will perform a free tire inspection to look for uneven or abnormal tire wear.

SPRINTER VAN

Tires should be rotated every 6,000 to 8,000 miles. For the longest tire life, any time irregular wear is seen have the tires checked, alignment checked, and tires rotated by your truck or tire dealer. Have the cause of uneven wear corrected.

Rotation pattern for single and dual rear wheels.

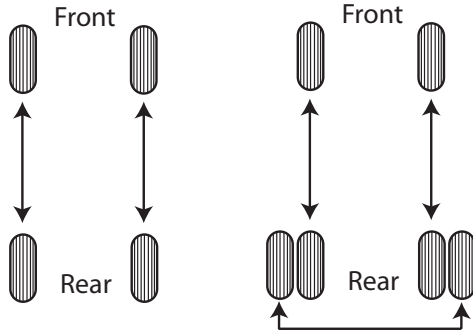

NOTICE: Read Sprinter manual for complete instruction on tire rotation, installation, and maintenance.

Vehicles with aluminum alloy wheels may require tires to be dismantled and remounted so as to leave rims in original locations.

SUPPORT

Since motorhomes may sit for long periods it is important to properly support the tires if blocks are used for leveling.

Extreme caution must be taken to ensure that the tires are fully supported when using blocks to level motorhomes. The load on the tire should be evenly distributed on the block and in the case of duals, evenly distributed on blocks for both tires. If not properly done, the steel cables in the sidewall of the tires may be damaged and could lead to premature fatigue of the sidewall.

CORRECT

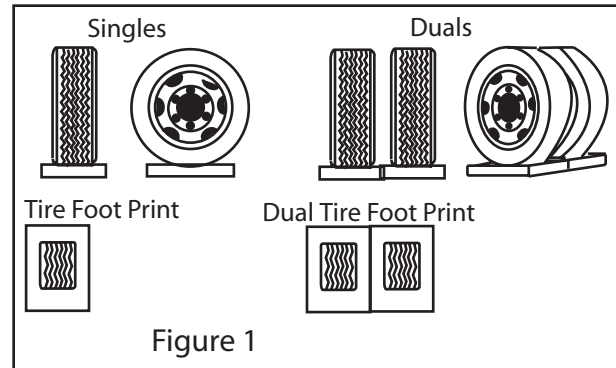

The **CORRECT** methods are shown in Figure 1. A single tire or dual tires are supporting the full load. Please note that the blocks are wider than the tread and longer than the tire's footprint. This provides maximum support to the tires and assures that the load is evenly distributed throughout the tire's footprint area.

INCORRECT

INCORRECT methods are shown in figure 2: One tire, a portion of one tire, or portions of two tires are supporting the full load.

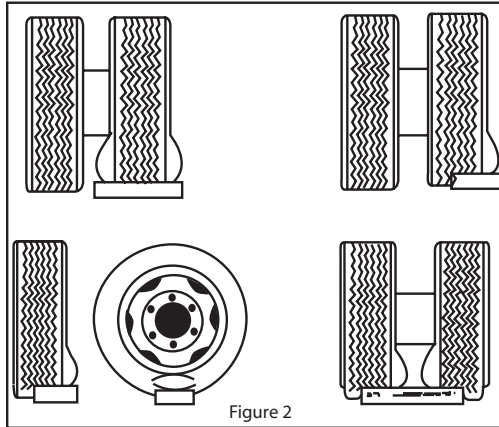

Figure 2



WARNING: Tires that are incorrectly supported may be damaged which could lead to casing failure resulting in serious injury or property damage. If, on previous occasions, the tires have been incorrectly supported, a hidden damage may be present. Please contact your local tire dealer and request an inspection and a determination of possible damage.

Aluminum Wheels (Option)

Maintenance Against Corrosion

1. Clean frequently with high pressure water from a hose. The use of a mild detergent will speed the cleaning process. Use no harsh alkaline cleaners.
2. When tires are removed the entire wheel must be cleaned and inspected. With a wire brush, remove any foreign products from the tire side of the rim. Do not use a wire brush to remove dirt and corrosion products from the appearance surface of the wheel. Generously coat the entire air chamber surface with an approved surface protectant and lubricant each time the tire is removed.

SPRINTER VAN

3. To maintain the original appearance of your Alcoa wheels, the following procedures are recommended:

a. Use a sponge, cloth or soft fiber brush to wash exposed wheel surfaces with a mild detergent and warm water solution.

 b. Rinse thoroughly with clean water.

c. Wipe dry to avoid water spots.

d. Wax the cleaned surface with Alcoa Advanced Aluminum Care System Polish or any automotive polish equivalent.

e. Clean your Alcoa wheels as frequently as required to maintain their appearance.

SAFETY

Emergency Exit

There are three avenues of escape from the motorhome in the event of an emergency, the driver's door, the passenger door, and the sliding side cargo door. As always, safety should be one of your top priorities. Make sure you, and everyone traveling with you, can operate these doors and exit rapidly without light. A little planning and a quick practice session at each camping site is well worth the time it may take.



WARNING: At each campsite make sure you have not parked in such a manner as to block the operation of the doors or the escape avenues by being too close to trees, fences or other impediments. Scenic views are one reason for traveling, but don't park so the beautiful lake or steep cliff is just outside your doors. Do not block access to the doors from the inside or outside of the vehicle.



WARNING: Read the directions carefully on the fire extinguisher. If there is any doubt on the operation, you and your family should practice, then replace or recharge the extinguisher. You will find your local fire department will be happy to assist you and answer any questions.



WARNINGS:

DON'T SMOKE IN BED!

KEEP MATCHES OUT OF REACH OF SMALL CHILDREN!

DON'T CLEAN WITH FLAMMABLE MATERIAL!

KEEP FLAMMABLE MATERIAL AWAY FROM OPEN FLAME!

**We have all heard these warnings many times,
but they are still among the leading causes of fires.**

Other safety information on the LPG system of your motorhome is located in the Plumbing Section of this manual.



CAMPING

SMOKE ALARM/CARBON MONOXIDE DETECTOR

Manufacturer: First Alert

Model SCO5RVA

UNITED STATES

BRK Brands, Inc.

3901 Liberty Street Road

Aurora, Illinois 60504

For consumer inquiries call: 800-323-9005

CANADA

Dicon Global, Inc.

20 Steelcase Road. West, Unit #3

Markham, Ontario.

L3R 1B2

Tel: 905-475-6006

Fax 905-475-8560

For consumer inquires call: 800-323-9005

IMPORTANT! Dangers, Warnings, and Cautions alert you to important operating instructions or to potentially hazardous situations. Pay special attention to these items.

Parts of this section on the Smoke Alarm/Carbon Monoxide Detector are a reprint of the manual included with each device and provided to you in the Airstream owner's briefcase. Please read, understand, and follow all aspects of the complete manual before activating and operating the Smoke Alarm/Carbon Monoxide Detector. If you have not received the manual, use the appropriate contact information above to obtain one or contact Airstream Customer Relations at 937-596-6111.

Features:

- Separate sensors to detect smoke and CO; the two alarm systems work independently
- Powered by two "AA" batteries
- Side access drawer for easy battery replacement



WARNING: Have a professional technician check all safety related systems yearly or whenever any doubts of their ability to function properly arise.

FIRE SAFETY TIPS

Follow safety rules and prevent hazardous situations: 1) Use smoking materials properly. Never smoke in bed. 2) Keep matches or lighters away from children;

3) Store flammable materials in proper containers; 4) Keep electrical appliances in good condition and don't overload electrical circuits; 5) Keep stoves and barbecue grills grease and debris free; 6) Never leave anything cooking on the stove unattended; 7) Keep portable heaters and open flames, like candles, away from flammable materials; 8) Don't let rubbish accumulate.

Keep alarms clean, and test them weekly. Replace alarms immediately if they are not working properly. Smoke Alarms that do not work cannot alert you to a fire. Keep at least one working fire extinguisher in your RV, and an additional one in the kitchen. Have fire escape ladders or other reliable means of escape from an upper floor in case stairs are blocked.



WARNING: Smoke and Carbon Monoxide Alarm is shipped with batteries deactivated. Ask dealer to activate batteries or activate batteries immediately upon delivery. Failure to follow warning will remove your protection.

Battery Activation

To activate battery pull labeled clear plastic tan from device. If tab was previously removed, test batteries and replace as needed.

BASIC SAFETY INFORMATION



CAUTION: This combination Smoke/Carbon Monoxide Alarm has two separate alarms. The CO Alarm is not designed to detect fire or any other gas. It will only indicate the presence of carbon monoxide gas at the sensor. Carbon monoxide gas may be present in other areas. The Smoke Alarm will only indicate the presence of smoke that reaches the sensor. The Smoke Alarm is not designed to sense gas, heat or flames.



WARNINGS:

- This Smoke/CO Alarm cannot operate without working batteries. Removing the batteries for any reason, or failing to replace the batteries at the end of their service life, removes your protection.
- NEVER ignore any alarm. See “If Your Smoke/CO Alarm Sounds” for more information on how to respond to an alarm. Failure to respond can result in injury or death.
- The Silence Features are for your convenience only and will not correct a problem. See “Using the Silence Features” for details. Always check your home for a potential problem after any alarm. Failure to do so can result in injury or death.
- Test this Smoke/CO Alarm once a week. If the Alarm ever fails to test

CAMPING

correctly, have it replaced immediately! If the Alarm is not working properly, it cannot alert you to a problem.

• This product is intended for use in ordinary indoor locations of family living units. It is not designed to measure CO levels in compliance with Occupational Safety and Health Administration (OSHA) commercial or industrial standards. Individuals with medical conditions that may make them more sensitive to carbon monoxide may consider using warning devices which provide audible and visual signals for carbon monoxide concentrations under 30 ppm. For additional information on carbon monoxide and your medical condition contact your physician.



WARNING: Test Units in your RV after the vehicle has been in storage, before each trip, and at least once a week while in use. Failure to test units used in RVs as described may remove your protection.

Horn Pattern Selection For Smoke Alarm

When the alarm detects smoke, the default horn pattern is 3 beeps, pause, 3 beeps. To manually change the horn pattern to 6 beeps, pause, 6 beeps: open the battery drawer (with batteries installed) , press and hold the test button down and then close the battery drawer.

To return to the default horn pattern of 3 beeps, pause, 3 beeps; open the

battery drawer and then close the battery drawer.

- In the U. S. the horn pattern is 3 beeps, pause, 3 beeps.
- In Canada the horn pattern is 6 beeps, pause, 6 beeps

Always test the alarm to verify the horn pattern for your area.

NOTE: see the First Alert User's Manual for information on optional locking features.

WEEKLY TESTING



WARNINGS:

• **NEVER** use an open flame of any kind to test this unit. You might accidentally damage or set fire to the unit or to your home. The built-in test switch accurately tests the unit's operation as required by Underwriters Laboratories, Inc. (UL). **NEVER** use vehicle exhaust! It may cause permanent damage and voids your warranty.

• **DO NOT** stand close to the Alarm when the horn is sounding. Exposure at close range may be harmful to your hearing. When testing, step away when horn starts sounding.



CAUTION: It is important to test this unit every week to make sure it is working properly. Using the test button is the recommended way to test this Smoke/CO Alarm.

Test this Smoke/CO Alarm: Press and hold the Test/Silence button 3-5 seconds until unit starts to alarm.

During testing, you will see and hear the following sequence:

- The **Horn** will sound 3 beeps, pause, 3 beeps. The **Power/Smoke LED** flashes Red and the **CO LED** will be Off. **NOTE:** For Canada the horn will sound 6 beeps, pause, 6 beeps. The **Power/Smoke LED** flashes Red and the **CO LED** will be Off.
- Next the Horn will sound 4 beeps, pause, 4 beeps. The **Power/Smoke LED** will be Off and the **CO LED** flashes Red.

If the unit does not alarm, make sure the batteries are correctly installed and test again. If the unit still does not alarm, replace it immediately.

Parts Of This Smoke/CO Alarm

1. Test/Silence Button
2. Battery Compartment
3. Power/Smoke Alarm LED
4. CO Alarm LED

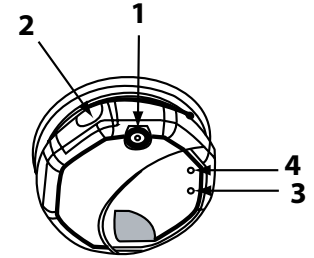

REGULAR MAINTENANCE

This unit has been designed to be as maintenance-free as possible, but there are a few simple things you must do to keep it working properly. Use only the replacement batteries listed below. The unit may not operate properly with other batteries. Never use rechargeable batteries since they may not provide a constant charge.

- Test it at least once a week.
- Clean the Smoke/CO Alarm at least once a month; gently vacuum the outside of the Smoke/CO Alarm using your household vacuum's soft brush attachment. A can of clean compressed air (sold at computer or office supply stores) may also be used. Follow manufacturer instructions for use. Test the Smoke/CO Alarm once a week. Never use water, cleaners or solvents since they may damage the unit.
- If the Smoke/CO Alarm becomes contaminated by excessive dirt, dust and/

CAMPING

or grime, and cannot be cleaned to avoid unwanted alarms, replace the unit immediately.

- Relocate the unit if it sounds frequent unwanted alarms. See “Where This Alarm Should Not Be Installed” for details.

Choosing a replacement battery:

Your Smoke/CO Alarm requires two standard AA batteries. It was shipped with two AA batteries. The following batteries are acceptable as replacements: Eveready Energizer E91. These batteries are available at many local retail stores.

IMPORTANT!

Actual battery service life depends on the Smoke/CO Alarm and the environment in which it is installed. All the batteries specified above are acceptable replacement batteries for this unit. Regardless of the manufacturer’s suggested battery life, you **MUST** replace the battery immediately once the unit starts “chirping” (the “low battery warning”).

To replace the batteries (without removing Alarm from the ceiling or wall):

1. Open the battery compartment.
2. Press tabs A and B as shown in the diagram and remove each battery.

3. Insert the new batteries, making sure they snap completely into the battery compartment. Match the terminals on the ends of the batteries with the terminals on the unit.
4. Close the battery compartment, and then test the unit by pressing the Test/Silence button.

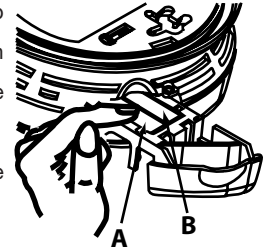

WARNING: The battery door will resist closing unless batteries are installed. This warns you that the unit will not operate without batteries.

IF YOUR SMOKE/CO ALARM SOUNDS

WHAT TO DO FIRST - IDENTIFY THE TYPE OF ALARM

Type of Alarm	What You See and Hear
Carbon Monoxide (CO)	CO LED: Flashes Red Horn: 4 beeps, pause, 4 beeps, pause. Power/Smoke LED: Off.
Smoke	Power/Smoke LED: Flashes Red Horn: (US) 3 beeps, pause, 3 beeps, pause. Horn: (Canada) 6 beeps, pause, 6 beeps, pause. CO LED: Off.

If The CO Alarm Sounds



DANGER: Actuation of your CO Alarm indicates the presence of carbon monoxide (CO) which can kill you. In other words, when your CO Alarm sounds, you must not ignore it!

1. Operate the Test/Silence button.
2. Call your emergency services, fire department or 911. Write down the number of your local emergency service here:

3. Immediately move to fresh air—outdoors or by an open door or window. Do a head count to check that all persons are accounted for. Do not reenter the premises, or move away from the open door or window until the emergency services responder has arrived, the premises have been aired out, and your CO Alarm remains in its normal condition.

4. After following steps 1-3, if your CO Alarm reactivates within a 24-hour period, repeat steps 1-3 and call a qualified appliance technician to investigate for sources of CO from fuel-burning equipment and appliances, and inspect for proper operation of this equipment. If problems are identified during this inspection have the equipment serviced immediately. Note any combustion equipment not inspected by the technician, and consult the manufacturers' instructions, or contact the manufacturers directly, for more information about

CO safety and this equipment. Make sure that motor vehicles are not, and have not, been operating in an attached garage or adjacent to the residence. Write down the number of a qualified appliance technician here:

“ALARM-MOVE TO FRESH AIR”

If you hear the CO alarm horn and the CO red light is flashing, move everyone to a source of fresh air. DO NOT remove the batteries!

IF THE SMOKE ALARM SOUNDS

RESPONDING TO AN ALARM



DANGER:

- **If the unit alarms and you are not testing the unit, it is warning you of a potentially dangerous situation that requires your immediate attention. NEVER ignore any alarm. Ignoring the alarm may result in injury or death.**
- **Never remove the batteries from a battery operated Smoke/CO Alarm to stop an unwanted alarm (caused by cooking smoke, etc.). Removing batteries disables the alarm so it cannot sense smoke, and**

CAMPING

removes your protection. Instead open a window or fan the smoke away from the unit. The alarm will reset automatically.

- If the unit alarms get everyone out of the motorhome immediately.

DEVELOP AND PRACTICE A PLAN OF ESCAPE:

WHAT TO DO IN CASE OF FIRE

- Don't panic; stay calm. Follow your family escape plan.
- Get everyone out of the motorhome as quickly as possible. Don't stop to get dressed or collect anything.
- Feel doors with the back of your hand before opening them. If a door is cool, open it slowly. Don't open a hot door. Keep doors and windows closed, unless you must escape through them.
- Cover your nose and mouth with a cloth (preferably damp). Take short, shallow breaths.
- Meet at your planned meeting place outside your motorhome, and do a head count to make sure everybody got out safely.
- Call the Fire Department as soon as possible from outside. Give your address, then your name.
- Never go back inside a burning motorhome for any reason.
- Contact your Fire Department for ideas on making your motorhome safer.

- Make a floor plan indicating all doors used as escape routes from the motorhome.
- Have a family meeting and discuss your escape plan, showing everyone what to do in case of fire.
- At each campground determine a place outside your motorhome where you all can meet if a fire occurs.
- Familiarize everyone with the sound of the Smoke Alarm and train him or her to leave your motorhome when they hear it.
- Practice a fire drill at least every six months or when ever new guests are with you. Practice allows you to test your plan before an emergency; you may not be able to reach your children or may be visiting a fellow camper while they sleep. It is important they know what to do.

Alarms have various limitations. See "General Limitations of Smoke/CO Alarms" for details.

USING THE SILENCE FEATURES



WARNING: Never remove the batteries to quiet an unwanted alarm. Removing the batteries disables the alarm and removes your protection. Do not use the Silence Feature in emergency situations. It will not correct a CO problem or extinguish a fire.

The Silence Feature is intended to temporarily silence the horn while you identify and correct the problem. The Silence Feature can temporarily quiet an unwanted alarm for several minutes. Press the Test/Silence button on the alarm cover for at least 3-5 seconds. After the Test/Silence button is released, the Red LED blinks during the silence mode.

SILENCING THE LOW BATTERY WARNING

When the Smoke Alarm Is Silenced	When the CO Alarm Is Silenced
The Smoke Alarm will remain silent for up to 15 minutes, then return to normal operation. If the smoke has not cleared—or continues to increase—the device will go back into alarm.	The CO alarm will remain silent for up to 4 minutes. After 4 minutes, if CO levels remain potentially dangerous the horn will start sounding again.

This silence feature can temporarily quiet the low battery warning “chirp” for up to 8 hours. You can silence the low battery warning “chirp”: press the Test/Silence Button on the alarm cover.

Once the low battery warning “chirp” silence feature is activated, the unit continues to flash the Green light twice a minute for 8 hours. After 8 hours, the low battery “chirp” will resume. **Replace the batteries as soon as possible; this unit will not operate without battery power!**

To deactivate this feature: Press the Test/Silence button again. The unit will go into Test Mode and the low battery warning will resume (LED flashes and unit sounds “chirp” once a minute).

WHAT YOU NEED TO KNOW ABOUT CARBON MONOXIDE (CO). WHAT IS CO?

CO is an invisible, odorless, tasteless gas produced when fossil fuels do not burn completely, or are exposed to heat (usually fire). Electrical appliances typically do not produce CO.

These fuels include: Wood, coal, charcoal, oil, natural gas, gasoline, diesel, kerosene, and liquid propane.

CAMPING

Common appliances are often sources of CO. If they are not properly maintained, are improperly ventilated, or malfunction, CO levels can rise quickly. CO is a real danger now that homes are more energy efficient. “Air-tight” homes with added insulation, sealed windows, and other weatherproofing can “trap” CO inside.

D SYMPTOMS OF CO POISONING

These symptoms are related to CO POISONING and should be discussed with ALL household members.

Mild Exposure: Slight headache, nausea, vomiting, fatigue (“flu-like” symptoms).

Medium Exposure: Throbbing headache, drowsiness, confusion, fast heart rate.

Extreme Exposure: Convulsions, unconsciousness, heart and lung failure. Exposure to Carbon Monoxide can cause brain damage, death.

Important!

This CO Alarm measures exposure to CO over time. It alarms if CO levels are

extremely high in a short period of time, or if CO levels reach a certain minimum over a long period of time. The CO Alarm generally sounds an alarm before the onset of symptoms in average, healthy adults. Why is this important? Because you need to be warned of a potential CO problem while you can still react in time. In many reported cases of CO exposure, victims may be aware that they are not feeling well, but become disoriented and can no longer react well enough to exit the building or get help. Also, young children and pets may be the first affected. The average healthy adult might not feel any symptoms when the CO Alarm sounds. However, people with cardiac or respiratory problems, infants, unborn babies, pregnant mothers, or elderly people can be more quickly and severely affected by CO. If you experience even mild symptoms of CO poisoning, consult your doctor immediately!

FINDING THE SOURCE OF CO AFTER AN ALARM

Carbon monoxide is an odorless, invisible gas, which often makes it difficult to locate the source of CO after an alarm. These are a few of the factors that can make it difficult to locate sources of CO:

- Motorhome well ventilated before the investigator arrives.
- Problem caused by “backdrafting.”
- Transient CO problem caused by special circumstances.

POTENTIAL SOURCES OF CO IN THE RECREATIONAL VEHICLE

Fuel-burning appliances like: a portable heater, gas kitchen range or cook top, furnace, hot water heater.

Damaged or insufficient venting: corroded or disconnected water heater vent pipe, leaking or damage furnace vent, or cracked heat exchanger, blocked or clogged appliance vents.

Improper use of appliances/device: operating fuel burning appliances or vehicle in an enclosed area (like a garage or screened porch).

Transient CO Problems: “transient” or on-again-off-again CO problems can be caused by outdoor conditions and other special circumstances.

The following conditions can result in transient CO situations:

1. Excessive spillage or reverse venting of fuel appliances caused by outdoor conditions such as:

- Wind direction and/or velocity, including high, gusty winds. Heavy air in the vent pipes (cold/humid air with extended periods between cycles).
- Negative pressure differential resulting from the use of exhaust

fans.

- Several appliances running at the same time competing for limited fresh air.
- Vent pipe connections vibrating loose from the furnace, water heater or other fuel burning appliances.
- Obstructions in or unconventional vent pipe designs which can amplify the above situations.

2. Extended operation of non vented fuel burning devices (cooktop).

3. Temperature inversions, which can trap exhaust close to the ground.

4. Motorhome idling in an open or closed attached garage, or near a home.

These conditions are dangerous because they can trap exhaust in your motorhome.

Since these conditions can come and go, they are also hard to recreate during a CO investigation.

HOW CAN I PROTECT MY FAMILY FROM CO POISONING?

A CO Alarm is an excellent means of protection. It monitors the air and sounds a loud alarm before Carbon Monoxide levels become threatening for average, healthy adults.



CAMPING

A CO Alarm is not a substitute for proper maintenance of home appliances.

To help prevent CO problems and reduce the risk of CO poisoning:

- Clean appliance vents yearly. Keep them free of debris, leaves, and nests for proper air flow. Also, have a professional check for rust and corrosion, cracks, or separations. These conditions can prevent proper air movement and cause back drafting. Never “cap” or cover a vent in any way that would block air flow.
- Test and maintain all fuel-burning equipment annually. Most RV service centers offer appliance inspections for a nominal fee.
- Make regular visual inspections of all fuel-burning appliances. Check appliances for excessive rust and scaling. Also check the flame on the burner and pilot lights. The flame should be blue. A yellow flame means fuel is not being burned completely and CO may be present. Keep the blower door on the furnace closed. Use vents or fans when they are available on all fuel-burning appliances. Make sure appliances are vented to the outside. Do not grill or barbecue indoors, or in garages or on screen porches.
- Check for exhaust back flow from CO sources. Check the draft hood on an operating furnace for a back draft. Look for cracks on furnace heat exchangers.

- Check the RV beside you at a campground. CO can come in an open window or vent
- Keep windows and doors open slightly. If you suspect that CO is escaping into your motorhome, open a window or a door. Opening windows and doors can significantly decrease CO levels.
-

GENERAL LIMITATIONS OF SMOKE/CO ALARMS

Smoke/CO Alarms may not waken all individuals. Practice the escape plan before every excursion and with all newcomers to the vehicle, making sure that everyone is involved. Allow children to master fire escape planning and practice before holding a fire drill at night when they are sleeping. If children or others do not readily waken to the sound of the Smoke/CO Alarm, or if there are infants or family members with mobility limitations, make sure that someone is assigned to assist them in a fire drill and in the event of an emergency. It is recommended that you hold a fire drill while family members are sleeping in order to determine their response to the sound of the Smoke/CO Alarm while sleeping and to determine whether they may need assistance in the event of an emergency.

Smoke/CO Alarms cannot work without power. Battery operated units cannot work if the batteries are missing, disconnected, or dead, if the wrong type of batteries are used, or if the batteries are not installed correctly. AC units

cannot work if the AC power is cut off for any reason (open fuse or circuit breaker, failure along a power line or at a power station, electrical fire that burns the electrical wires, etc.). If you are concerned about the limitations of battery or AC power, install both types of units.

This Smoke/CO Alarm will not sense smoke or CO that does not reach the sensors. It will only sense smoke or CO at the sensor. Smoke or CO may be present in other areas. Doors or other obstructions may affect the rate at which CO or smoke reaches the sensors. Consider installing another alarm device (Combination CO and Smoke Alarm, or separate CO Alarms and Smoke Alarms) if you habitat areas you believe need protection.

Smoke/CO Alarms may not be heard. The alarm horn loudness meets or exceeds current UL standards of 85 dB at 10 feet (3 meters). However, the Smoke/CO Alarm may not wake up a sound sleeper or one who has recently used drugs or has been drinking alcoholic beverages. This is especially true if the door is closed or only partly open. Even persons who are awake may not hear the alarm horn if the sound is blocked by distance or closed doors. Noise from traffic, stereo, radio, television, air conditioner, or other appliances may also prevent alert persons from hearing the alarm horn. This Smoke/CO Alarm is not intended for people who are hearing impaired.

The Alarm may not have time to alarm before the fire itself causes dam-

age, injury, or death, since smoke from some fires may not reach the unit immediately. Examples of this include persons smoking in bed, children playing with matches, or fires caused by violent explosions resulting from escaping gas.

This Smoke/CO Alarm is not a substitute for life insurance. Though this Smoke/CO Alarm warns against increasing CO levels or the presence of smoke, Airstream Inc. and/or BRK Brands, Inc. does not warrant or imply in any way that they will protect lives. Motorhome owners and users must still insure their lives.

This Smoke/CO Alarm has a limited life. Although this Smoke/CO Alarm and all of its parts have passed many stringent tests and are designed to be as reliable as possible, any of these parts could fail at any time. Therefore, you must test this device weekly. The unit should be replaced immediately if it is not operating properly. Any Smoke/CO Alarm that is beyond its replacement date should be replaced immediately.

This Smoke/CO Alarm is not foolproof. Like all other electronic devices, this Smoke/CO Alarm has limitations. It can only detect smoke or CO that reaches the sensors. It may not give early warning of the source of smoke or CO is in a remote part of the motorhome, away from the alarm device.

CAMPING

The First Alert Users Manual provided in your owner's packet has troubleshooting and other important information. Please read, understand, and follow all information contained the First Alert Manual. If you have any questions concerning the alarm that cannot be answered in this manual or the First Alert manual please contact First Alert Consume Affairs at 1 800.323.9005, M-F 7:30 AM to 5:00 PM (CST) or Airstream Customer relations 937.596.6111.



LP GAS DETECTOR

THIS ALARM HAS A SEVEN YEAR LIFE, SEE END OF LIFE NOTIFICATION IN LP DETECTOR MANUAL. PLEASE READ ENTIRE DETECTOR MANUAL BEFORE OPERATING UNIT.

In the kitchen area of your unit is the LP gas detector. LP gas is a mixture of gases produced and sold commercially as a fuel for heating and cooking appliances. LP gas is highly flammable and, as a result, can be explosive if ignited under certain circumstances. LP gas is heavier than air and, if confined in a closed space, will accumulate close to the floor. The LP gas detector is designed to alarm at less than 25% of the legal explosive limit. It will provide a visual and audible alarm by sounding an alarm every 5 seconds and lighting the red LED.

Your LP gas detector is wired directly to your vehicle battery and incorporates a

1-amp in-line fuse. It has no internal battery back up. In Normal Stand By Mode the LED indicator will be green.

LOW VOLTAGE

The operating voltage for the detector is 12 VDC. The actual voltage supplied to the detector in a recreational vehicle may drop below the minimum 8 VDC. The detector is designed to provide the user with a LOW VOLTAGE WARNING before reaching that level and to provide additional distinct, clear warnings and alarms after the 8 VDC level is reached. However, if available power supplied to the unit is below the operating voltage of 8 VDC the detector will not detect gas or provide you protection against dangerous levels of LP Gas.



DANGER: Activation of this detector indicates the presence of LP gas, which can cause an explosion and/or fire causing death or serious injury. This normally indicates a leak in the LP gas installation or a LP gas appliance. Extinguish all open flames, open your windows and door and evacuate the unit immediately. Do not activate any electrical switch. Turn off the LP at your gas bottle(s). DO NOT RE-ENTER YOUR UNIT UNTIL A QUALIFIED REPAIR TECHNICIAN HAS CORRECTED THE PROBLEM AND CERTIFIED THE SYSTEM AS SAFE.



DANGER: It is not recommended that the detector be

disconnected from the battery during periods of storage. There is a small heater on the sensor of the device, which “burns” away impurities in the air during periods of normal use. During periods when power is interrupted, impurities can build up on the sensor. When power is returned to the detector the detector alarm may activate until the impurities are “burned” off. This could take a number of hours, during which time the alarm will be constantly “on”.

DETECTOR TEST

The Test/Rest button is used to verify proper alarm function. Executing the test function sounds the alarm and lights up the red LED. The test will sound the alarm twice, with 4 “beeps” in one second followed by 5 seconds of silence. By pressing the button you can verify that the alarm sounds and the LED functions properly.



DANGER Have a qualified technician check your LP Gas system annually or if you have any signs of leaks or malfunctions.

OVERNIGHT STOP

In time you will develop a knack for spotting wonderful little roadside locations by turning off the main highway and exploring. There are many modern recreational vehicle parks, including State, County and Federal parks with good facilities, where you may obtain electrical, water and sewer hookups and connections. Directories are published which describe in detail these parks and tell what is available in the way of services and hookups.

All you need to do to enjoy the self-contained luxury is to:

1. Turn on LP gas supply and light appliance pilots if required.
2. Turn on water pump and open faucets until air is expelled from the system.

Before moving on, turn off the LP gas and water pump. Check your campsite, both for cleanliness and to be sure you haven’t left anything behind. Make sure everything is properly stowed.

Overnight or Weekend Trips

On overnight or weekend trips, chances are you will not use up the capacity of the holding tanks, deplete the water supply, or run down the battery which supplies the living area 12 volt current.

CAMPING

LONGER TRIP

On a longer trip, when you have stayed where sewer connections and utility hookups were not available, it will be necessary for you to stop from time to time to dispose of the waste in the holding tank and replenish the water supply. Many gas stations (chain and individually owned) have installed sanitary dumping stations for just this purpose. Booklets are available which list these facilities.

When you stop for the night, your Airstream motorhome is built to be safely parked in any spot that is relatively level and where the ground is firm. Your facilities are with you. You are self-contained. Try to pick as level a parking spot as possible.

EXTENDED STAY

Making a long trip is not very different from making a weekend excursion. Since everything you need is right at hand, you are at home wherever you go. When packing for an extended trip, take everything you need, but only what you need.

When you plan to stay in the same place for several days, weeks or months, you will want your motorhome to be as level as possible. Check the attitude

with a small spirit level set on the inside work counter. If a correction is necessary, then you must first level from side to side. This can be done most easily by driving up a small ramp consisting of 2" x 6" boards tapered at both ends. **WE DO NOT RECOMMEND PLACING TIRES IN A HOLE FOR LEVELING.** Check the tire section of the chassis portion of this manual for information on tire support.

Hook Up to Water by attaching a ½ " minimum high-pressure water hose to the city water service.

Plug the **110 volt, 30 amp Electrical Cable into the City Power Service.** Be sure you have the wire grounded and have the proper polarity. See Electrical Section for technical details.

To use the **Generator** you simply start it. All switching is done automatically. The generator can be started from the switch inside the curbside rear roof locker. It is easier on your generator and appliances if you'll allow the generator to reach its normal operating speed (about a minute) prior to applying heavy current loads.

A **Cable/Satellite TV** connection is located in the exterior compartment along with the switches for the dump valves, macerator pump and macerator pump high pressure hose reel.

Turn on the gas supply. Lighting a top range burner to bleed any air from the system will make it easier to start other appliances including the furnace.

When you stay for extended periods where electric or water hookups are not available, you must make regular checks on the condition of your 12-volt battery and the contents of your water tank. Carry drinking water in a clean bucket to refill your tank. When your waste tanks nears capacity, move your motorhome to a dumping location.

EFFECTS OF PROLONGED OCCUPANCY

Your motorhome was designed primarily for recreational use and short-term occupancy. If you expect to occupy the motorhome for an extended period, be prepared to deal with condensation and the humid conditions that may be encountered. The relatively small volume and tight compact construction of modern recreation vehicles mean that the normal living activities of even a few occupants will lead to rapid moisture saturation of the air contained in the motorhome and the appearance of visible moisture, especially in cold weather.

Just as moisture collects on the outside of a glass of cold water during humid weather, moisture can condense on the inside surfaces of the motorhome during cold weather when relative humidity of the interior air is high. This condition is increased because the insulated walls of a recreation vehicle are much thin-

ner than house walls. Estimates indicate that two adults can vaporize up to one and a half gallons of water daily through breathing, cooking, bathing, and washing. Unless the water vapor is carried outside by ventilation, or condensed by a dehumidifier, it will condense on the inside of the windows and walls as moisture, or in cold weather as frost or ice. It may also condense out of sight within the walls or the ceiling where it will manifest itself as warped or stained panels. Appearance of these conditions may indicate a serious condensation problem. When you recognize the signs of excessive moisture and condensation in the motorhome, action should be taken to minimize their effects.

Note: Your motorhome is not designed, nor intended, for permanent housing. Use of this product for long term or permanent occupancy may lead to premature deterioration of structure, interior finishes, fabrics, carpeting, and drapes. Damage or deterioration due to long-term occupancy may not be considered normal, and may under the terms of the warranty constitute misuse, abuse, or neglect, and may therefore reduce the warranty protection.

To avoid condensation problems, try to follow these tips to help alleviate excess moisture:

Allow excess moisture to escape to the outside when bathing, washing dishes, hair drying, laundering, and using appliances and non-vented gas burners.

CAMPING

Always use an exhaust fan when cooking.

Keep the bathroom door closed and the vent or window open when bathing and for a period of time after you have finished.

Do not hang wet clothes in the motorhome to dry.

D In hot weather, start the air conditioner early as it removes excess humidity from the air while lowering the temperature.

Keep the temperature as reasonably cool during cold weather as possible. The warmer the vehicle, the more cold exterior temperatures and warm interior temperatures will collide on wall surfaces, thus creating condensation.

Use the ceiling vent to keep air circulating inside the vehicle so condensation and mildew cannot form in dead air spaces. Allow air to circulate inside closets and cabinets (leave doors partially open). Please keep in mind that a closed cabinet full of stored goods prevents circulation and allows the exterior temperature to cause condensation.

The natural tendency would be to close the vehicle tightly during cold weather. This will actually compound the problem. Simply put, you need to remove some of the warm air, and allow some cool outside air to get inside the vehicle, so the

furnace will not recycle the humid interior air.

Minimize use of incandescent lights, which produce heat and contribute to condensation.

ABOUT MOLDS

What are molds?

Molds are microscopic organisms that naturally occur in virtually every environment, indoors and out. Outdoors, mold growth is important in the decomposition of plants. Indoors, mold growth is unfavorable. Left unchecked, molds break down natural materials, such as wood products and fabrics. Knowing the potential risks is important for any type of homeowner to protect their investment.

What factors contribute to mold growth?

For mold growth to occur, temperatures, indoor or outdoors, must be between 40 degrees and 100 degrees Fahrenheit and also have a source of moisture, such as humidity, standing water, damp materials, etc. Indoors, the most rapid growth occurs with warm and humid conditions.

How can mold growth be inhibited?

By controlling relative humidity, the growth of mold and mildew can be inhibited. In warm climates, use of the air conditioner will reduce the relative humidity. Vents are located in the bathing and cooking areas and constant use is advised during food preparation and bathing, even during colder weather. Additionally, opening a window during these activities will assist in ventilation. In extremely humid conditions, the use of a dehumidifier can be helpful. If using a dehumidifier, please read and follow all manufacturer instructions and recommendations to the use and cleaning of the dehumidifier.

Frequent use of your RV or cleaning regularly is an important preventive measure. Further, any spills should be wiped up quickly and dried as soon as possible. Avoid leaving damp items lying about. On safe surfaces, use mold or mildew killing cleaning products. Check sealants regularly, and reseal when necessary to avoid water leaks. Proper preventive maintenance to the RV and its accessories, as described both in this manual and in accompanying literature, will provide the best protection to the RV.

WINTER TRAVELING

Traveling in your motorhome during the cold winter months can be a most exhilarating experience. There are, of course, certain precautions that must be taken as you would in your home in low temperatures.

The Interstate motorhome has 12-Volt heat pads installed with the fresh water and grey water holding tanks. The black water tank is above the floor allowing heat from the furnace to protect it from freezing. The lighted switch, when switch is lit the heating pad is on, for the heating pads is located on the forward shower wall inside the sliding cargo door. To conserve battery power, RV antifreeze may be used to protect the gray and black tanks. Battery power will last about 4 hours unless the unit is plugged into a 120-volt shoreline or the generator is ran to operate the inverter/charger.

Some states do not allow LPG to be turned on while moving. While traveling in these states you must use your common sense. How cold is it? How long will it be before you can turn the heat back on? Is the temperature dropping or rising? Remember, the wind chill factor when driving 50 MPH will cause the interior of the motorhome to cool much faster than when it is parked.

1. You must have a plentiful supply of propane gas as the heat from the furnace warms the motorhome and keeps the fresh water lines and black

CAMPING

water holding tank from freezing.

2. If your stay is longer than overnight, you should endeavor to have 120-volt electricity available. The house battery, fully charged, will not last more than about 15 hours in freezing weather, less (4 Hours) with use of the tank heating pads. Of course, you can run your generator to recharge the battery, or even use the generator continually. Keep an eye on your LP Gas or engine fuel according to the type of generator your motorhome is equipped with. Since the generator starts off the house battery, it is recommended to start the generator prior to running the battery down.
3. Minimize use of electricity if 120-volt power source is not available.
4. Leave cabinet doors, wet bath doors and wardrobe doors slightly open at night to allow circulation of air in and around all components.
5. Save 12-volt power by using non-toxic RV approved antifreeze in greywater holding tank instead of heating pad to prevent freezing. Quantity of antifreeze needed will vary with ambient temperature and the amount of liquids in tank.
6. For extended stays in cold weather, insulate all water lines outside the motorhome. You should remember that low temperatures in combination

with high winds cause an equivalent chill temperature much below what your thermometer is reading. For instance, with an outside temperature of zero degrees, and the wind velocity of 10 miles per hour, the equivalent chill temperature is minus 20° F.

7. Remember to remove and drain the exterior shower faucet to prevent freeze damage.

Exterior Sliding Step

The curbside sliding door has a sliding step w/auto retract, step out warning buzzer, and a lock extended switch located just inside the sliding door on the forward shower wall. Please read, understand, and instruct passengers of the following operational and safety information pertaining to the step:

The step extends and retracts as the sliding door is opened and closed with the engine off and step lock extend switch off. The step will not extend with the engine running.

The step retracts automatically and will not extend when the engine is started and running to prevent damage while in transit.

If the step does not retract fully a warning buzzer will sound. The vehicle should

not be driven if the step fails to retract completely.

The step 20 amp fuse is located in the Sprinter fuse panel under the driver's seat, position F-10.

Lock Extended Switch

To use the lock extend switch, turn the engine off, open the door to extend the step, and turn the switch on. The step will now remain extended while opening and closing the door. Turn the switch off to return step to normal operating mode.



WARNING: The lock extended switch must be turned off before starting the engine. Failure to follow this instruction may cause property damage or personal injury.

If you forget to turn the lock extended switch off before starting the engine, the step will retract when the engine is started, however it will not extend when the engine is turned off and the door is opened. To reset the step: turn the engine off and the step lock extended switch off with the door closed.



WARNING: LOOK BEFORE YOU LEAP. The step will not extend with the opening of the sliding door when the engine is running. Check

that step is extended before leaving and entering vehicle. Failure to follow this warning could result in person injury.

NOTICE: Check step is retracted before moving vehicle. Failure to follow this caution could result in property damage.

CAMPING

NOTES

D

The exterior of your Airstream Interstate Motorhome, except for the optional body kit, has been painted by Sprinter. The care of the paint is detailed in the Sprinter manual.

The following additional information is provided by Airstream to help you understand the finish and its care. Following these instructions will provide a long lasting, high-gloss finish for your recreational vehicle. These same procedures can also be applied to your everyday automobile, producing the same long-lasting results.

NOTICE: Information on finish care may provide addition information and tips on the use of the Van as a motorhome, however, no information about the exterior finish of your motorhome in this manual should be interpreted as advice or directions to disregard or void the warnings, cautions, or other information contained in the Sprinter's manuals.

Waxes and Polishes

Over 90 percent of all automotive finishes are clear coat. The finish on your RV is a state-of-the-art Acrylic Urethane Basecoat/ClearCoat. This means that what you will wash and polish is a clear urethane coating designed to protect the basecoat: the pigmented coating that provides color. As its main function of protecting the basecoat, clearcoats need to be maintained especially

in harsh environments. Clearcoats do not fade themselves, but appear to fade or lose gloss as the surface becomes contaminated by the environment. If this contamination is not removed frequently, results will be a dull or low gloss finish. Occasional washing alone will not adequately remove some forms of contamination and will require polishing.

Polishes and waxes primarily served the following purposes:

1. To remove minor surface imperfections caused by water spots and acid rain.
2. To remove minor scratches by filling them and leveling the surface.
3. To beautify the paint finish appearances with more depth and high-gloss.
4. To protect the paint finish from the elements.

Do not use products that contain harsh abrasives such as rubbing or polishing compounds. These products should be used by experienced technicians with the proper training and equipment. Most polishes and waxes are designed to clean and polish in one application.

A hand applied polish or wax will offer outstanding performance and protect the Interstate's finish. When applying polish or wax, do so in a shaded area making sure the surface is at the specified temperature according to the polish manufacturers recommendations. Due to the variations of polishes and waxes,

EXTERIOR

incorporate the following suggestions into the polishing technique:

1. Condition the polishing pad by rubbing a slight amount of polish on it.
2. Use only the amount of polish specified in the label directions.
3. Work a small area at a time.
4. Rinse off and remove dried polish from crevices, trim and moldings.
5. Follow the products manufacturers directions.



How to Care for Your RV Finish

Keeping your RV looking its best at all times involves keeping the paint finish clean and in good condition. This means periodic washing and polishing, as well as getting the paint finish repaired as soon as possible when the paint is damage or affected in anyway. The purpose of the paint finish is two fold:

- (1) Provide an aesthetically pleasing appearance.
- (2) To protect the vehicle from the environment. Your RV is exposed to many environmental conditions that have an adverse effect on the paint finish:

1. ROAD SALTS AND SODIUM CHLORIDE
2. ROAD TAR/BUGS
3. BIRD DROPPINGS/TREE SAP
4. INDUSTRIAL FALLOUT/ACID RAIN/POLLUTION

5. ULTRAVIOLET EXPOSURE AND MOISTURE

The most common problems resulting from these conditions are corrosion, staining, and chemical spotting. These problems can be minimized through regularly scheduled washing and polishing.

Washing your RV:

Make sure the RVs surface temperature is not too hot, under 90 degrees Fahrenheit, and not in direct sunlight. A shady area is ideal for washing your vehicle as direct sunlight causes water and soap to evaporate too fast, resulting in water spotting. Use a mild soap or detergent. Most auto care stores carry a car wash shampoo. Try to avoid combination wash-n-wax products as these waxes cause buildup and are designed for smaller surfaces. Have two dedicated sponges or wax mitts: one for the paint finish and one for the wheels and under carriage. Brushes or wash mitts that have plastic bristles are acceptable for use on tires and wheel wells, but are not intended for use on the paint finish.

Avoid using such items on painted surfaces, as they will damage the RV paint and finish. Wash the wheels and wheel wells first as this removes heavy dirt and debris and prevents it from splattering on already clean panels. Wet the entire area down to remove loose dirt and grime, hand wash one area at time using your dedicated paint finish sponge or wash mitt. Wash from the top and

work your way down, frequently rinsing the rinsing to minimize grit abrasion. Follow with a final rinse of water.

This process will remove most contamination from the RVs surface. For stubborn stains such as road tar, use an ammonia based glass cleaner or a small amount of rubbing alcohol on a damp cloth immediately followed by warm soapy water and rinse with clean water. This may not dissolve the road tar, but will loosen tar and bugs stains and remove them from the surface. Do not use solvent based cleaners on bird droppings or tree sap as these are water-based stains and will eventually dissolve using an ammonia based glass cleaner, warm soapy water and a little “elbow grease”. Once again, after removing stubborn stains immediately rinse with clean water.

Drying the RV is just as important as washing your vehicle as today’s tap water and well water contain many chemicals that could water stain your RVs finish. We suggest using a damp natural or synthetic chamois, however, there are other drying products such as lint free micro-fiber towels that work just as well.

Follow the simple cautionary measures, and your new finish will give you maximum gloss and durability.

It is recommended that the caulking and sealant used in external seams and joints such as window frames, light bezels, beltline and rub-rail molding, etc.,

be checked regularly. If this material has dried out and becomes cracked or checked, or if a portion has fallen out, it should be replaced with fresh material to prevent possible rain leaks. Caulking and sealing material is available from your motorhome dealer and most RV supply stores.

Body Kit

The body kit provided by Airstream is made from state of art high impact plastic. The same material is used in the automotive industry for moldings, bumper guards, and trim. The kit is made to color specifications and requires no paint or finish. The cleaning procedures are the same as the painted finish on the Sprinter body, however there are several automotive plastic care products on the market for exterior parts that will provide added protection from UV ray damage, dirt, and stains. Find one you like and use it as often as needed to help prevent fading.



EXTERIOR

Roadside Exterior Features

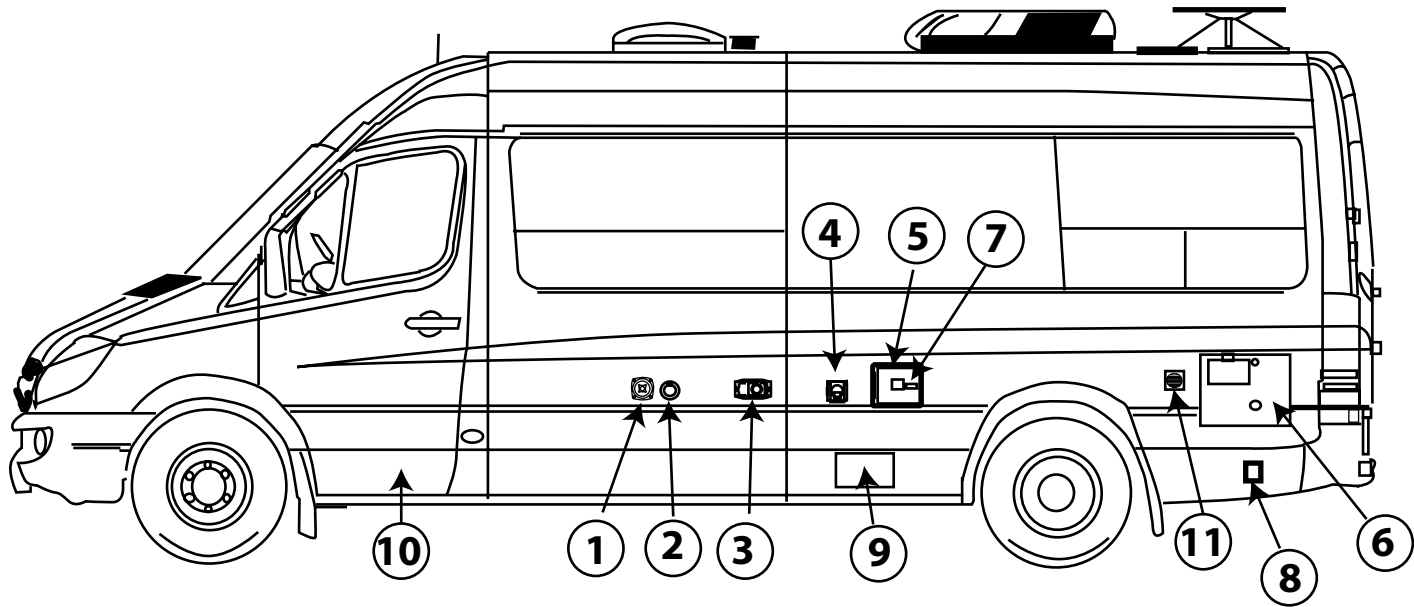

Roadside Exterior Features

NOTE: This is a basic explanation of the location and function of exterior features. More in depth explanations of certain feature's care and maintenance is include in this manual in other sections.

- 1. City Water Hook-up** provides access for city water to your fresh water system. Use ½" minimum hose for water supply.
- 2. Water Fill** is used to fill the fresh water tank. Use only clean fresh potable water.
- 3. Furnace exhaust vent** should be cleaned regularly. When operating furnace, be sure exhaust can escape into a well-ventilated area. Air coming from vent can be hot, when parking the motorhome, be sure to have proper clearance in venting area.
- 4. Exterior Shower** outlet can be used on the water pump or with the city water hook up after faucet/valve/hose assembly is inserted.
- 5. Utility Hatch** contains the cable/satellite TV inlet, the switches for the dump valves, macerator pump and macerator pump high pressure hose reel.

6. Electronic Ignition Water Heater Door and Vent is part of the plumbing system. The intake vent, drain plug and exhaust vent are located inside this door. Regular maintenance by a qualified service technician is required to keep the water heater operating efficiently.

7. Cable/Satellite TV inlet is located inside the utility hatch and is pre-wired for cable/satellite TV. A portable satellite dish can be connected and used in the cable connection.

8. 110 Volt Power Cord Inlet, 30-amp service is required, power cord is stored inside rear cargo doors in a plastic storage compartment.

9. Macerator hose reel compartment stores the electric reel holding the pump hose and the **Black Tank Flush**.

10. Body kit.

11. House Battery Vent (Rear Twin Model Only) allows battery gasses from the battery compartment located under the rear lounge to escape and fresh air to enter.

EXTERIOR

Curbside Exterior Features

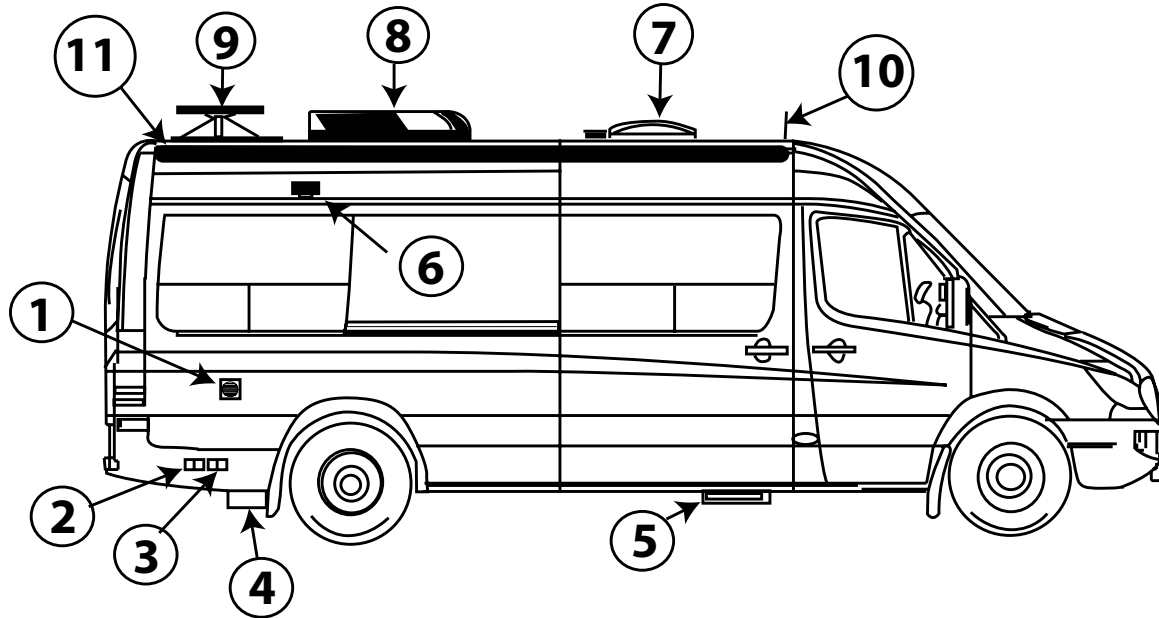

Curbside Exterior Features

NOTE: This is a basic explanation of the location and function of exterior features. More in depth explanations of certain feature's care and maintenance is include in this manual in other sections.

1. **House Battery Vent (Rear Lounge Model Only)** allows battery gasses from the battery compartment located under the rear lounge to escape and fresh air to enter.
2. **Exterior 110 Volt Outlet** provides an exterior GFI protected electrical source.
3. **TV Outlet/12 Volt Power Port** provides reception for an exterior television. It is pre-wired and integrated into the Cable TV/Satellite TV system. There is also a 12 Volt outlet.
4. **LP tank** remote fill and shutoff.
5. **Sliding Step w/Auto Retract** has a step out warning buzzer and a lock extended switch for easy entry into the motorhome.
6. **Porch Light** is switched just inside the sliding cargo door on the forward

shower wall.

7. **MaxxAir Roof Vent, exhaust only**, complete operating instructions are in the appliance section of this manual. Keep all vents clear to encourage airflow.
8. **Roof Air Conditioner**
9. **Power Boosted Omni-Directional TV Antenna** is wired into TV outlets on exterior of coach and inside unit at entertainment center cabinet.
10. **Radio Antenna**
11. **Patio Awning** operating and care instructions are including in this section of this manual.



EXTERIOR

PATIO AWNING

Awning Motor Pre-wire: Units equipped with the standard manual awning are prewired for the addition of a motor to convert to power operation. Four wires are located inside the removable rear panel of the rear roof locker. Those four wires run through the body to under the passenger cab seat where two other wires are run from the chassis fuse panel under the driver's seat. The switch can be mounted inside the compartment on the side of the passenger seat.

E

MANUAL OPERATION

NOTICE: The sliding cargo door must be shut to extend the awning, without this happening the arm and the opening cover will contact the door possible cause damage to the awning or door finish. Once the awning is extended the sliding door will open and shut fine without any interference.

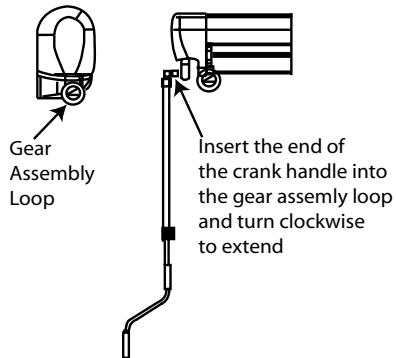

TO EXTEND AWNING

1. Hook awning extension crank into gear motor loop and extend awning about 36 inches.

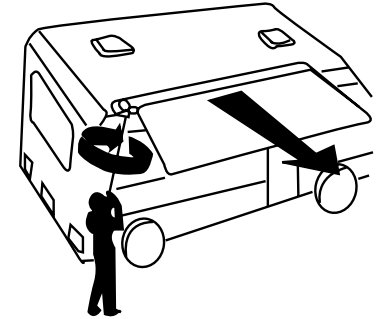

2. Unscrew the leg tension knob.

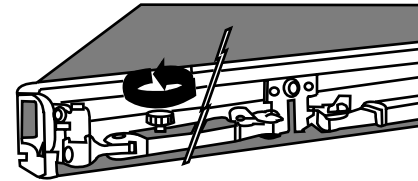

3. Take the leg near its hinge-joint and pull it in a horizontal direction.

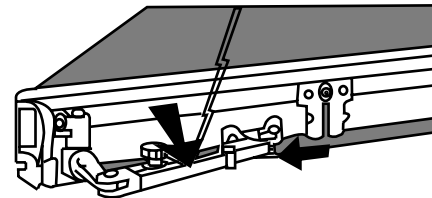

4. After leg clears case, rotate leg down and extend leg to the ground. Use leg tension knob to secure leg length to ground. Repeat with other leg. NOTE: Awning poles are stored on the floor behind the rear center sofa and are accessed by opening the rear cargo doors. When traveling store the poles securely using the straps provided.

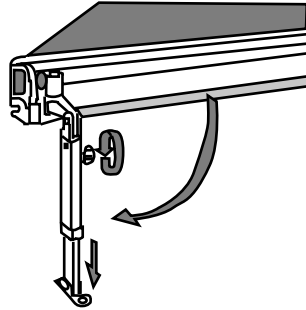

4a. To use the carport position, legs sitting on the ground, crank the awning completely out while moving the support arms each time when necessary.

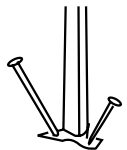
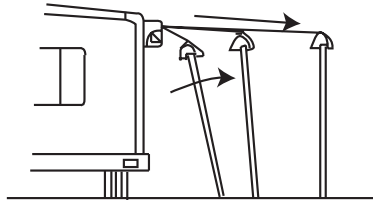

Drive ground stakes through the holes in the carport foot and into the ground for support or tie off on a rope stake.



CAUTION. GROUND STAKES WILL NOT PREVENT THE AWNING FROM MOVING IN THE WIND!

4b. To use the bottom brackets, swing each arm toward the vehicle, lift the bracket pin and position foot into bracket and then release the pin. Then turn crank until awning is all of the way out. Turn the crank back a partial turn to back wind the awning slightly. This tightens the fabric.

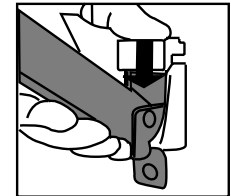
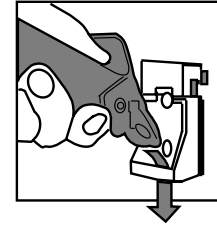
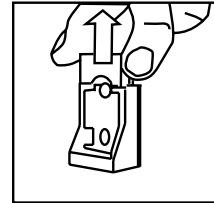
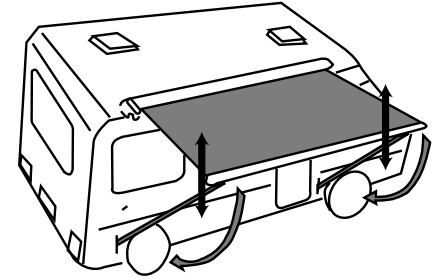

After unrolling the awning completely fix the legs at the chosen height.

EXTERIOR

To stow the awning reverse the extend procedure.

NOTICE: Never use the awning with damaged fabric. Make sure the awning can be correctly rolled up. A damaged fabric does not allow a correct rolling up of the awning.

AWNING USE IN WIND AND RAIN.

E We remind you that the awning is a sun protection, so please roll up your awning in case of rain, wind or snow. Otherwise take the following precautions: To prevent water build up on the awning, position one upper arm substantially lower than the other to create enough of a slope for adequate water run off and use a tension rafter available from Fiamma. (See figure below)

To avoid the awning being taken up by a sudden wind, causing possible damage to the vehicle by the swinging of the legs. It is necessary to secure the legs to the ground with the provided hooks. As a supplementary security we strongly advise to make use of a storm cord at the upper side of each support leg, or to acquire and anchor the legs with the Fiamma Toe-Down Kit Strap. (See figure below)

NOTE: IF WIND OR EXTENDED PERIODS OF RAIN ARE EXPECTED, ROLL UP THE AWNING AND SECURE AS FOR TRAVEL!

NOTICE: THE EFFECTS OF WIND AND RAIN ON ANY AWNING ARE UNPREDICTABLE. SEVERE DAMAGE TO THE VEHICLE AND OR THE AWNING MAY RESULT AND CANNOT BE COVERED BY WARRANTY!

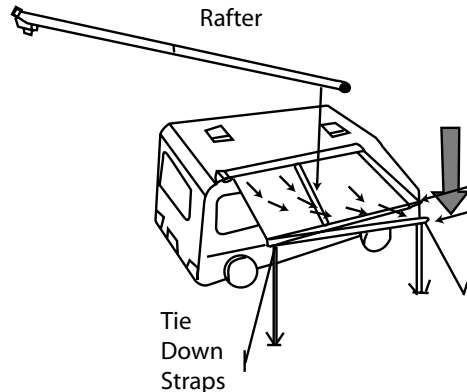

POWER AWNING (Option)

The switch for the power awning is located on the passenger seat pedestal and accessed by opening access door on the seat pedestal. While the carport leg deployment procedure can be used with the power option, Airstream recommends following the procedure using the legs inserted into the brackets mounted on the side of the unit.

NOTE: Awning will not extend while vehicle engine is running.

CARE AND MAINTENANCE

1. CARE OF FABRIC: Fiamma recommends cleaning with Fiamma Brill.
2. PERIODIC MAINTENANCE Like any other part of the RV, an owner should periodically inspect the awning. The following items should be checked.
 - A. All mounting brackets are tight.
 - B. Check all pivot points for enlargements of holes or broken rivets.
 - C. Check end caps for cracking, splitting.

- D. Check that awning rail is tight against coach and all screws are tight.
- E. Check canopy for loose stitching and possible shrinkage or puckering.
- F. Clean and lubricate all tension knobs and pivot points.

Fuse Location: Chassis fuse panel under driver's seat, position F-10.



INTERIOR

The interior of your Airstream motorhome has been designed to take a limited amount of space and provide you with all the comfort, convenience, durability and appearance possible. An understanding of the operational procedures and maintenance techniques of the interior appointments will add to your pleasures, as well as to the long life of your motorhome.

Driver and Passenger Seats

The driver and passenger seats are provided by Sprinter, sent out to be recovered by Airstream to match the interior decor.

The seat adjustment mechanism provided by Sprinter allows the seat to be moved forward or backward and swivel left or right. A release bar under the front of the seat is used to move the seat forward and backward. Pressing down on a handle centered under the front of the seats allows the seat to swivel. Return seat to full upright position before using swivel adjustment.

Lumbar and other seat adjustments are part of the reupholstered Sprinter seat and their operation is explained in the Sprinter manual.



DANGER: Adjust the driver's seat so that you can easily reach and operate all controls. Make sure seat is locked in position. Do not

adjust driver's seat swivel or fore and aft mechanism while vehicle is moving. The seat could move unexpectedly causing loss of control.

Captain's Chairs, 2nd Row

The captains chairs have 3 adjustments. A lever on the side of the seat reclines the seat back. A lever on the seat pedestal under the front of the seat allows the seat to be adjusted forward or back, and a lever on the pedestal under the side of the seat allows the seat to swivel. Return seat to full upright position before using swivel adjustment.

NOTICE: Seat backs on cab and 2nd row seats must be returned to full upright position and seat moved forward before seat is swiveled. Failure to do so could result in damage to the seats upholstery, the wall panels, and the seat decorative skirt.

Rear Lounge/Bed

The dinette seats and rear center lounge transform into a rear bed. The center power lounge is operated by a switch located under the curbside rear roof locker. Remove headrests and press switch to lower seat back.

The side dinette seats fold out by lifting up on the seat edge and pulling out.

The backrests will slide down into place as the seats slide out. Raise the countertop extension before pulling out the roadside sofa to prevent the sofa from hitting it. To sleep stow the extension.

Clean ultra leather coverings with standard products used for that purpose. **Follow instructions on the cleaning products container.**

NOTE: Never remove cushion covers for separate dry cleaning or washing. Any tumble cleaning method can destroy the backing, shrink or otherwise damage upholstery fabric.



WARNING: Keep your furniture and family safe from fires caused by careless smoking. Do not smoke when drowsy. Remove immediately any flowing ash or a lighted cigarette, which falls on furniture. Smoldering smoking material can cause upholstered furniture fires.

Dinette Table

The dinette table is a pedestal table. The top is stored between the galley and the captains chair. The table pedestal is stored in back of the rear center sofa on the rear lounge model accessed by opening the two rear cargo doors and inside the roadside wardrobe in the twin bed model. The pedestal table can be

placed in floor mounted threaded holders located between the dinette seats or the 2nd row captain chairs. The pedestal is inserted into the floor cups and twisted to lock into place.



WARNING: Return table top and pedestal to their respective storage positions before moving vehicle. In a emergency stop or accident the top and pedestal could cause personal injury and /or death.

Vinyl Floor

The vinyl floor in your unit can be cleaned and waxed with products recommended for vinyl floors.



CAUTION: Warn occupants entering the vehicle when the floor is wet or fresh wax has been applied. Just like a home, the floor can be slippery and falls are possible.

Cabinets/Overhead Lockers

The furniture is manufactured from of a high-pressure laminate and can be cleaned with soap and water, or you can use a common solvent on tough spots. Furniture polish can be used sparingly. Glass doors must be cleaned with a anti-static cleaner and cloth. Windex or common ammonia products will

INTERIOR

damage the coating on the surface.

Notice: Do not use any abrasive material. Abrasive cleaners, cloths and pads as there is the possibility they could scratch the surface. A protective pad should always be placed under hot utensils.

Wet Bath

To clean your fiberglass shower stall unit, use warm water and a liquid detergent. Do not use abrasive cleaners; they may scratch and dull the surface of your fiberglass unit. Stubborn stains can be removed with solvents such as turpentine, paint thinner or acetone. Restore dulled areas by rubbing with an automotive-type liquid cleaner, and then put the soft glow back into the sides of your unit with a light application of liquid wax. DO NOT wax the shower bottom as it may become slippery leading to a fall.

Bath Wall Extension.

The bath wall next to the toilet is hinged and is designed to extend into the hallway to provide more space. A latch at the top of the swinging wall is provided to release and secure the wall in two positions. The wall should be always be secured by the latch in whatever position you decide to use.



WARNING: During transit Airstream recommends the wall be retracted and secured, freeing up hall space for emergency exits.

Galley Sink/Faucet

SMEV

WWW.SMEV.COM

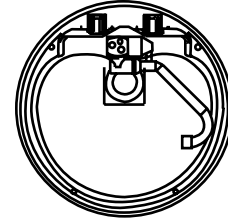

To use: Open lid and rotate faucet to upright position. Open hot or cold faucet as needed.

Clean Acrylic lid with warm soapy water, no abrasives. For the stainless steel sink each sink comes with a packet of SMINOX stainless steel polish/cleaner which is included with your owner's case. This would be the preferred cleaner for sink appliances per SMEV, however any stainless steel (non-abrasive) cleaner is fine.

Notice: Do not use any abrasive cleaners or cloths on surfaces.

Lavatory Sink/Shower Faucet

The lavatory shower/sink faucet is equipped with a retractable, adjustable showerhead. It has ceramic valves with chromed brass construction. The faucet spout can be pulled out for use as a shower or left in place for the sink. The spray can be adjusted by turning the spout end. The chrome finish can be cleaned with warm, mild, soapy water and a clean soft cloth.

NOTICE: Do not use abrasive cleaners, pads, or cloths to clean the chrome finish. This will damage the finish and is not covered by your warranty.

Metal Interior Skin

The metal interior skin on the ceiling is coated with a baked on acrylic coating. Use soft rags or wash mitts always moving lengthwise with the grain of the aluminum. NEVER rub hard on the coating. Oil, grease, dust and dirt may be removed by washing with a 5% solution in water of commonly used commercial and industrial detergents. Cleaning should be followed by a thorough clean water rinse. Drying the metal with a chamois or a soft cloth may prevent spots and streaks. WHEN WASHING OR WAXING THE METAL, ALWAYS WIPE “WITH” THE GRAIN OF THE METAL.

After cleaning and drying, a good grade of nonabrasive automotive paste or liquid wax once a year will increase the life of the finish and help remove minor scratches and abrasions. It will also protect the metal from minor scratches and make subsequent cleaning easier.

If a substance is found on the coating that cannot be removed by normal washing procedures, Airstream recommends using DX 330 Acryli-Clean made by PPG Industries. Follow all directions and warnings on the product container. Acryli-Clean should be used by trained personnel only, using the proper equipment under controlled conditions. Use the Acryli-Clean as sparingly as possible to remove oil or grease. Rinse with cool water immediately after use.

NOTICE: ABRASIVE POLISHES OR CLEANING SOLVENTS SUCH AS AUTOMATIC DISHWASHER OR ACID ETCH CLEANERS ARE TOO STRONG AND SHOULD NEVER BE USED. RINSE ALL GRIT FROM SURFACE PRIOR TO WASHING. Use soft rags always moving lengthwise with the unit. NEVER rub hard on the coating. Even the softest rag will damage the coating if excessive pressure is applied.

INTERIOR

Upholstery

Cleaning Instructions for Ultraleather™

Spot clean with mild soap and water.

Air dry or dry quickly with warm setting of a hair dryer.

For stubborn stains, use mild solvent (ie. Fantastic or Formula 409).

Disinfect with a 5:1 bleach solution.

Dry cleanable by conventional methods using commercial dry cleaning solvents.

This material cannot be machine-washed.

Stain Removal:

Use mild detergent for coffee, tea, red wine, liquor, soft drinks, milk, ketchup, steak sauce, soy sauce, mayonnaise, butter, salad oil, chocolate, cosmetic foundation, lipstick, face cream, suntan oil/lotion, shoe polish and urine.

Use a mild cleaning fluid (Woolite) on stains like machine oil and on more stubborn stains when mild detergent is not enough.

Shades

Day/Night shades are lowered and raised by the bars running across the shade. To raise and lower the complete assembly, grasp in the center of the bottom bar or place hands evenly on the bar. Lift or lower the bar to open or close the shade. A second bar has two knobs to lower and raise the day part of the shade. Rough roads and long trips may cause the pleated shades to move slightly during travel. Tensions on the strings at the sides of the shades adjust the ease of operation and their ability to stay up during travel. Do not over-tighten as this may cause the string to break, requiring service.

A feather duster or the soft-bristled brush often found as part of vacuum cleaner attachments, are recommended for cleaning the pleated shades. The longevity of the pleated shades will be increased if the shades are closed, glass shows, when your vehicle is stored.

Counter Tops/Backsplash

The standard counter top is manufactured from of a high-pressure laminate. Laminates will burn, scratch, and stain, so you'll have to be considerate of your countertops to keep them looking good.

- Regular applications of appliance wax or light furniture wax will help lami-

nate surfaces resist stains and scratching.

- Never use abrasive cleansers or steel wool on laminate countertops.
- For general cleaning, a two-sided scrubbing pad with fiber on one side and a sponge on the other works particularly well. Moistened slightly with water, the fiber side is just abrasive enough to loosen greasy smears and other soil.

The optional counter top is a Lite Gran solid surface material. It has a fiberglass core with a tough Acrylic coating.

You have to go out of your way to harm an acrylic countertop. A very hot pan will leave a permanent burn mark on the surface, but scouring powder or steel wool will remove stains and scratches. For routine cleaning, use a mild abrasive cleanser applied directly to the wet surface. Rinse well and buff with a soft cloth. Remember the top is coated with acrylic and not solid acrylic.

For Lite Gran Repair Procedures please contact:

Better Way Products, Inc.

70891 CR 23

New Paris, IN 46553

Phone/Fax: 574-831-3340 / 574-831-3611

Email: dockbox@npcc.net

Bath Exhaust

The round bath exhaust is operated by pushing up on the handle to raise the fan lid. A push button switch will activate the fan.

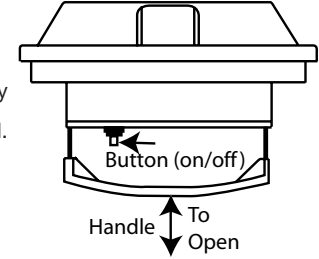

High Volume Exhaust fan

MAXXAIR VENT FAN

Model 00-06201-005

MAXXAIR CORP.

Corporate Headquarters 5513 West Sligh Ave

Tampa, FL 33634

The MaxxFan is a unique, one-of-a-kind ventilation system that keeps your RV interior safe from any weather- rain or shine. It circulates hot, musty air out - at any time - in any weather. It includes a built-in rain shield that moves into position, automatically, every time the MaxxFan vent is opened. Best of all, this rain shield tucks away when the MaxxFan is closed, providing a low profile, euro-style appearance.

The MaxxFan opens and closes like most standard roof vents using a manual knob located at the ceiling. The controls for the fan are placed at the ceiling around the fan intake screen. In addition, the MaxxFan features an easy-to-

INTERIOR

remove screen. Simply rotate four retaining knobs and remove the screen for cleaning, no tools required. The MaxxFan's large exhaust vent employs a rigid louver system that, along with the internal heavy-duty screen, keeps rain, debris and critters from entering the vent area when opened.

Note: The MaxxFan is designed to be fully opened or fully closed when the vehicle is moving.

CAUTIONS AND CARE OF THE MAXXFAN

This product has been manufactured using prime UV stabilized Polymers for maximum toughness and durability. However, the use of non-compatible chemicals will cause cracking and product failure.

Please clean all parts with mild soap and water only.

Do not use Petroleum Containing Additives or Solvent Based Products on any of the MaxxFan's components or its corrosion resistant hardware.

Listed below are some known chemical products to be aware of:

NON COMPATIBLE CHEMICALS - DO NOT USE THESE:

Keytones, Esters, Acetone or other like solvents, Halogenated Hydrocarbons,

Amines, Aromatic Hydrocarbons, (Loctite Formulas), or references re: chemicals that are not to be used on Plastics.

GENERALLY COMPATIBLE (But should be used in low concentration where possible)

Acids, Alcohol, Alkalis, Aliphatic Hydrocarbons, Mild Soap solution (avoid strong Alkaline material), Silicone Oil or Greases (avoid those containing Aromatic Hydrocarbons or other additives). **Review the contents of your cleaning materials carefully.**

If your MaxxFan fails to operate properly under normal conditions, please call MaxxAir using the toll free number listed below or your dealer. If calling MaxxAir, please have the motorhome retail sales date and the MaxxFan Serial Number readily available when you call. The Serial number for your MaxxFan is located on the fan control plate under the round insect screen frame. Reference your operating guide. Rotate the four retaining knobs 180 degrees and remove the screen to view. Do not operate the MaxxFan with the screen removed

Maxxfan Toll Free Customer Service

(800) 780-9893, 8:00 am - 5:00 p.m. EST, Monday - Friday

Light Bulbs

All interior lights are sealed LED requiring fixture replacement if a light burns out or malfunctions. The exterior lights are the same except for the porch light which uses a B7038 bulb replacement.



DANGER: Always replace the light bulb or light fixture with the correct bulb or matching fixture for that light. Always be sure power is tuned off and bulb or fixture is cool before removing. Take proper precautions on a broken bulb or fixture to prevent lacerations. Failure to heed these warnings could cause fire, property damage, personal injury, or death.

Privacy Curtain

Privacy curtains are provided for the front windshield and cab windows. The curtains have pockets sewn into them that slide over the sunvisors and straps on each end that slide over the seat belt mechanism.

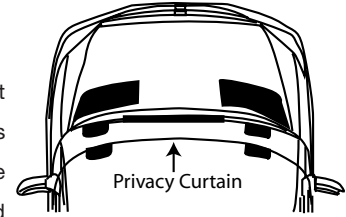

Light brushing with an upholstery brush or gentle use of a vacuum cleaner will suffice in most situations. For heavy soiled conditions Dry-Clean only. Washing the curtain may void the warranty.

INTERIOR

NOTES

F

LPG SYSTEM

Your motorhome is equipped with a permanently mounted tank for LPG (Liquid Petroleum Gas) with a remote fill and remote gas supply shut off switch. LPG burns with a clean blue flame, Propane is used where subfreezing temperatures are common, since it freezes at -40° F. How long a full tank of gas will last is dependent on usage. In cold weather, when you are using the furnace, or when you use large amounts of hot water, or cook extensively, you will naturally use more than you will in warm weather, or when you may do limited cooking. On the average, with normal cooking and other appliance use, you can probably count on two to four weeks of usage from the tank.

If you have allowed the tank to run out, air may have gotten into the lines. In this event the air must be allowed to bleed from the lines before lighting appliances. Follow the appliance manufacturers instructions and light the appliance closest to the LP supply tank. Then move to the next closest, etc.

LP TANK REMOTE FILL

The LP tank is filled by accessing the remote fill hook up located in the compartment under the passenger side rear fender behind the rear wheels. Be sure the fill is free of dirt. It may help to remind your LP supplier to only use a clean fill hose to fill your tank. Turn off the remote switch when the LP system is not

in use as it draws 12 volt current from the batteries.



WARNING: Only certified LP suppliers should fill the LP Tank. Turn remote gas supply switch off before filling or refilling LP tank.



WARNING: Always shut off the LP gas when refueling the motorhome.

Remote Gas Supply Switch

A remote switch for shutting off the gas to all appliances is located in the same compartment. The switch activates an electric solenoid that opens and closes, shutting the gas off at the tank. The switch rotates ¼ turn. This switch should be turned off during the filling of the LP tank. **NOTE:** The electric gas shut-off solenoid closes automatically when 12-volt power is disconnected. It will reopen when power is restored.



WARNING: All LP gas appliances must be turned off during refueling of motorhome fuel tank and permanently mounted LPG tank.

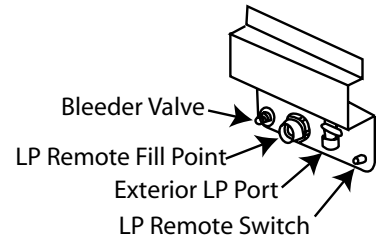

PLUMBING

Gas lines should be checked periodically for leaks with ammonia free soapy water.



DANGER: Do not use open flame to search for problems. If gas can be smelled, appliance pilots fail to stay on, or any other abnormal situation occurs, use the remote supply switch to shut off the tank valve immediately and call on a qualified LPG service center or Airstream Service Center.



CAUTION: Moisture in the LPG tank will cause a malfunction of the regulator in controlling proper pressure. This may result in the flame lifting off the burner, or the flame may go out frequently. Many refueling stations will add approximately ¼ to ½ gallon of alcohol to lower the moisture temperature. Moisture will then pass through the regulator without the formation of ice crystals.

LPG Regulator

The LPG regulators used on Airstream motorhomes are designed for low-pressure service, with a normal outlet pressure setting of 11.5 inches water column. Only personnel trained in the proper procedures, codes, standards, etc., should service regulators. Have the regulator inspected each time the tank is refilled. Replace any regulator that has had water in the spring case, or

shows evidence of external corrosion, or corrosion inside the spring case.

BASIC RULES FOR SAFETY



DANGER:

DO NOT store LP containers within vehicle. LP containers are equipped with safety devices that vent gas should the pressure become excessive.

DO NOT use cooking appliances for comfort heating. Cooking appliances need fresh air for safe operation. Before operation open overhead vent or turn on exhaust fan and open window.

A warning label has been located in the cooking area to remind you to provide an adequate supply of fresh air for combustion. Unlike homes, the amount of oxygen supply is limited due to the size of the recreational vehicle, and proper ventilation when using the cooking appliances will avoid dangers of asphyxiation. It is especially important that cooking appliances not be used for comfort heating as the danger of asphyxiation is greater when the appliance is used for long periods of time.

Portable fuel burning equipment, including wood and charcoal grills and stoves, shall not be used inside the recreational vehicle. The use of this equipment inside the recreational vehicle may cause fires or asphyxia-

tion.



A Warning Label has been located near the LP gas container. This label reads: **DO NOT FILL CONTAINER (S) TO MORE THAN 80% PERCENT OF CAPACITY. Overfilling the LP gas container can result in uncontrolled gas flow that can cause fire or explosion. A properly filled container will contain approximately 80 percent of its volume as liquid LP gas.**

Do not bring or store LP gas containers, gasoline or other flammable liquids inside the vehicle because a fire or explosion may result.



DANGER: If you smell gas:

1. Extinguish any open flames, pilot lights and all smoking materials.
2. Do not touch electrical switches.
3. Shut off the gas supply using the remote shut off switch.
4. Open doors and other ventilating openings.
5. Leave the area until odor clears.
6. Have the gas system checked and leakage source corrected before using again.

LP gas regulators must always be installed with the diaphragm vent facing downward. Regulators that are not in compartments have been equipped

with a protective cover. Make sure that regulator vent faces downward and that cover is kept in place to minimize vent blockage that could result in excessive gas pressure causing fire or explosion.

The regulator at the L.P. tank is under a gray plastic cover. The protective cover certainly helps to keep the vent on the regulator from being clogged by wasps or ice, but should still be checked regularly to make sure the vent remains clear.



DANGER: Do not attempt to seal regulator cover.



WARNING: Check vent each time tank is filled to make sure it is clear of obstructions.

PLUMBING

LPG CONNECTIONS

A quick connect low pressure LPG connection is located under the passenger side rear quarter panel behind the dual wheels. It is a utility connection to use for an outside grille or other LPG appliance.

The connections are relative easy to use. Check that the remote LPG shut off switch is turned completely off. Slide the collar on the female end back and plug the male hose into the connection. Release the collar and check that the hose is properly connected by giving a firm pull on the hose. Turn the LPG remote shut off switch on and recheck all connections to the appliances and quick connection to be sure no leaks are present.

Follow all instructions, cautions, and warnings presented in this manual when connecting and disconnecting appliances.

WATER SYSTEM - SELF-CONTAINED

The fresh water system consists of a city water hook up, fresh water tank gravity fill, fresh water tank and drain valve, water-pump, pump filter, hot and cold water lines, water heater, fresh water line low point drain valves, and faucets. Full explanations on the locations and use of these feature are explained in this section.

Before using a water system, check that the water heater by-pass valve is turned to the use position. The by-pass valve is located on the back of the water heater under the lounge on the roadside, accessed by opening the rear cargo doors and reaching under the lounge. See Winterizing and Storage for further information on the By-Pass. Check that the exterior water heater drain plug is installed. Close all low point drain valves and the fresh water tank drain valve.

To operate the system with the water pump:

Fill the water tank by opening the exterior gravity feed water fill door. A garden hose can now be inserted or use a clean bucket and funnel to fill the tank. It's a good idea to let the water run through a hose for a short time to flush it out. RVers sometimes fill their tanks with "home" water to avoid strange water that may be distasteful to them on short outings. Remember the more water you

carry in the fresh water tank, the less cargo carrying capacity you have for other items.

The amount of water in the tank may be checked on the Monitor Panel, or you may fill the tank until water overflows out of the fill.

Fill the water heater by opening the hot side of either the galley, wet-bath, or exterior shower faucet and turning on the water pump switch located under the galley roof locker or by connecting to an exterior city water source. Close the cold side of all faucets. For some time the open faucet will only sputter. This is because the water heater is being filled and air is being pushed out through the lines. Once the water heater is full, a steady stream of water will come from the faucet.

Now open a cold faucet. It will sputter for a short time, but will soon expel a steady stream. All other faucets can now be opened until all air is expelled.

Once the system is filled with water and the faucets are closed, the water pump will shut off. When a faucet is opened the pump will come back on automatically. If the faucet is just barely open it is normal for the pump to cycle on and off rapidly.

It is normal for a pump to occasionally cycle when all faucets are off to keep

the water pressure at the set point. However, if it cycles frequently (more than a few times an hour) the plumbing system, pump, and pump strainer should be checked to be sure it is not losing pressure through a slow water leak or back through the pump.

NOTICE: To prevent equipment damage the water heater should only be started after the water system is primed and ready for use.

NOTICE: Turn the water pump off when the motorhome is left unattended.

Water Pump And Strainer

Manufacturer:

USA	Canada
Flojet	Fluid Products Canada
20 Icon	55 Royal Road
Foothill Ranch, CA 92610	Guelph, Ontario, N1H 1T1
Phone: 949-859-4945	519-821-1900

The water pump and strainer are located under the galley, accessed by removing the galley drawer. The strainer should be visually checked for accumulation of sand or debris that could affect water flow.

PLUMBING

To clean the strainer screen: With the clear plastic at the top press on the sides of the strainer releasing the tabs holding the clear plastic top in place, hold the sides in and pull straight up on the clear plastic top to remove the screen assembly. Rinse all debris from the screen. Replace the screen assembly by aligning the screen in the seating grooves and pressing gently down until tabs catch and hold the clear plastic top in place.

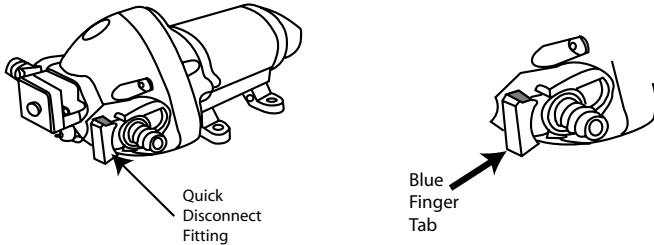

The inlet and outlet hoses and the strainer assembly are held in place by self sealing blue quick connect fittings. To disconnect a hose or the strainer grasp the blue tab on the female fitting by the grooved finger edges and pull straight out on the tab. This will release the male fitting connected to the hoses and strainer. Be sure that both the female and male fitting on the disconnect are free of all debris and are not damaged before replacing. Check the pump system for leaks anytime the disconnect fittings on the hoses and/or strainer are removed.

NOTICE: Failure to check the quick disconnect fitting for water leaks when reinstalling inlet and outlet hoses or the water pump strainer may cause the pump system to leak causing damage to personal property.

To operate the system using a city water source:

CITY WATER HOOKUP

The city water inlet is a standard garden hose thread. Use a high-pressure RV/Marine FDA approved drinking waterhose of at least ½ " diameter made from material that is tasteless, odorless, and non-toxic. We suggest you carry two lengths of hoses so you have the ability to reach hookups further away than normal, plus you have a spare should one fail or become damaged unexpectedly.

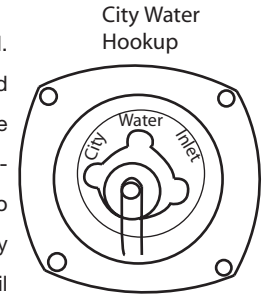

After hooking up the hose and turning on the city water valve provided in the park, slowly open a faucet. There will be spurts and sputtering until all the air is expelled from the motorhome system. Be sure to turn the water heater bypass to the normal flow position as described earlier in this section so it will fill. If the water heater is empty it will take some time before all the air is expelled and you get a steady flow of water at the faucet. Once a steady flow is achieved

at one faucet, the others should be opened long enough to expel the air in the lines going to them.

Your plumbing system has a built in pressure regulator to protect your lines and faucets from extremely high pressures on some city water systems. An after-market external regulator is not recommended, as it could lower the water pressure at the inlet and thus to your faucets and shower.

Sanitizing

Potable water systems require periodic maintenance to deliver a consistent flow of fresh water. Depending on use and the environment the system is subject to, sanitizing is recommended prior to storing and before using the water system after a period of storage. Systems with new components, or ones that have been subjected to contamination, should also be disinfected as follows:

1. Use one of the following methods to determine the amount of common household bleach needed to sanitize the tank.
 - A) Multiply “gallons of tank capacity” by 0.13; the result is the ounces of bleach needed to sanitize the tank.
 - B) Multiply “Liters of tank capacity” by 1.0; the result is the milliliters of bleach needed to sanitize the tank.
2. Mix into solution the proper amount of bleach within a container of water.

3. Pour the correct amount of solution (water/bleach) into the freshwater tank and fill with potable water.
4. Open all faucets (Hot & Cold) allowing the water to run until the distinct odor of chlorine is detected.
5. The standard solution must have four (4) hours of contact time to disinfect completely. Doubling the solution concentration will allow for contact time of one (1) hour.
6. When the contact time is completed, drain the tank. Refill with potable water and flush the plumbing of all sanitizing solution.

NOTE: The sanitizing procedure outlined above is in conformance with the approved procedures of RVIA ANSI A 119.2 and the U.S. Public Health Service.

EXTERIOR SHOWER

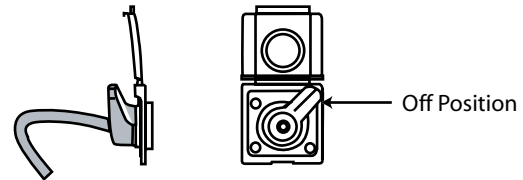

An exterior shower is provided for your convenience. The shower valve/hose assembly is stored inside the rear doors. To use: lift the hinged exterior cover, align the handle to the off position, and insert the shower handle assembly

PLUMBING

into the wall mounted shower inlet. The assembly can only be inserted and removed with handle aligned to the off position. Press the spout button and rotate the handle counter clockwise to the desired temperature. To remove handle assembly, return the handle to the off position, press the spout button to relieve any residual pressure and pull the handle out of the wall insert. Snap cover completely shut so rubber o-ring seal will seal and road dust and grime from the insert assembly. Be sure to remove and drain the hose and open the valves before opening the low point drain lines for winterization.

HEATED FRESH WATER TANK

G

The Interstate motorhome has 12-Volt heat pads installed with the fresh water and grey water holding tanks to help prevent freezing. The tank pads are controlled by a lighted switch located on the forward shower wall just inside the sliding door. The switch is lit when the pads are on. Battery power will last about 4 hours unless the unit has a 120-volt source (generator or shoreline) to operate the inverter/charger. To conserve battery power in a remote location RV antifreeze may be used to protect the tanks in freezing conditions.

DRAIN VALVE LOCATIONS

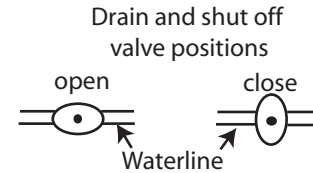

The fresh water system has four fresh water line low point drain valves. There is two under the galley accessed by removing the drawer and two under the curbside lounge or bed accessed by removing the cup holders. The cup holders lift up and out of the armrest.

The fresh water tank drain valve is located on the front of the tank pan under the motorhome.

SHUT OFF VALVES

There is one shut off valve in the motorhome. It is for the toilet and is on the water feed line beside the toilet base.

TOILET

Manufacturer:

Thetford Corporation

7101 Jackson Road

Ann Arbor, MI 48103

313-769-6000

Canada:

Thetford Sanitation Ltd.

2710 Slough Street

Mississauga, Ontario

Canada, L4T 1G3

The RV toilet in your Airstream is a design that has been used for many years. In normal use, when you are hooked up to city water, both pedals are depressed together. This dumps the sewage and flushes fresh water down the side of the bowl. Water will continue to run into the bowl for a short time after the pedals are released. Follow manufacturers instruction on operating, cleaning, and sanitizing toilet.

NOTICE: When you dump the bowl of the toilet make sure all paper and solids have cleared the slide mechanism before you allow it to close.

Trouble Shooting

1. Leaks:

- a) Back of toilet: check water supply line connection at water valve. Secure or tighten as necessary. If leak persists from water valve, replace.
- b) Vacuum breaker leaks while flushing: replace Vacuum Breaker or

water module, depending on model.

c) Between closet flange and toilet: check flange nuts for tightness.

If leak continues, remove toilet and check flange height. Use

Thetford spacers to adjust, if necessary, to 7/16" above floor.

Replace flange seal.

2) Toilet won't hold water:

a) Check for and remove any debris from blade/ball seal track.

b) Check blade/ball seal compression with mechanism.

If blade/ball seal is worn, replace.

3) Harder than normal pedal or hand lever operation: Apply light film of Thetford Toilet Seal Lubricant & Conditioner or silicone spray to blade/ball. (Note: To avoid damage do not use spray lubricants other than silicone.)

4) Poor flush: Pedals or hand levers must be held fully open during flush. A good flush should be obtained within 2 to 3 seconds. If problem persists, remove the water supply line and check flow rate. The flow rate should be at least ten quarts (9.5 liters) per minute.

PLUMBING

MAINTENANCE

If the bowl-sealing blade does not operate freely after extended use, it may be restored to its original, smooth operating condition by applying a light film of silicone spray to the blade. To clean the toilet use Thetford Aqua Bowl or any other high grade, non-abrasive cleaner. Do not use highly concentrated or high acid content household cleaners. They may damage the rubber seals.

REMOVAL

G

1. Shut off water valve behind toilet or main water supply and flush toilet.
2. Disconnect water supply line from toilet. You will probably find a small mirror very useful.
3. Remove mounting nuts.
4. Cover riser or tank inlet with cardboard to prevent debris from falling into tank.

NOTE: Always replace flange seal when toilet has been removed.

Toilet Winterizing

Draining Method: Turn off RV's water supply. Drain toilet bowl. Disconnect supply line at water valve. Completely drain the toilet's water supply line.

NOTICE: To avoid damage, when using air pressure to blow water from the lines, be sure toilet valve is in the open position.

NOTICE: If water is frozen in the toilet, do not attempt to flush until the ice thaws.

Antifreeze Method: Use RV (potable) antifreeze only.

NOTICE: Never use automotive type antifreeze.

For Thetford service centers: USA 1-800-521-3032

Canada: 1-888-215-5410

STORAGE AND WINTERIZING

NOTE: Sprinter recommends disconnecting the current to all chassis electric consumers using the Battery isolator Switch if the vehicle sits for periods longer than 2 months. It is located to the right of the accelerator pedal in the driver's foot well. Slide the red release down and pull it off the post. This will save jump starts, battery charge ups and possibly battery damage and replacement. The Sprinter manual describes its location, operation, and cautions in detail.

When storing your motorhome use the same precautions as you would in your own home in regard to perishables, ventilation, winterizing, and rain protection. In addition, for prolonged storage periods flush out all the drain lines and waste holding tanks. Also drain the entire water system, including the water heater and the fresh water tank. Instructions for draining the water system are explained in the following paragraphs on winterizing.

Twice a year, or after a long storage period, we suggest you take your unit into your Airstream dealer for a check-up and cleaning of the gas operated appliances.

The main consideration in winterizing is to guard against freezing damage to the fresh water lines, the waste drain lines, the waste holding tanks, the water

heater, and the batteries.

Plan your winterizing ahead and be sure the holding tanks are drained and flushed thoroughly at a proper disposal station. After dumping tanks add a quart or two of RV non-toxic anti-freeze to one of the holding tanks and start the macerator pump. Run until the anti-freeze comes out the end of the pump hose. Leave dump valves open. As extra protection, open the toilet valve and add a cup of non-toxic RV anti-freeze to the black tank and pour a cup of non-toxic antifreeze into a sink drain to protect the holding tanks and valves from residual water freezing. (This is very important, as the frozen sewage could seriously damage the tank.)

To completely winterize your motorhome follow this procedure:

1. Level the motorhome from side to side and front to rear, turn the water pump off and disconnect the city water.
2. Open all the hot and cold water faucets.
3. Open the low point drain valves for the hot and cold water lines, the fresh water tank drain valve, and water heater drain. There are three fresh water line low point drain valves. There is one under the galley accessed by removing the drawer and in the lounge model there two under the curbside lounge

PLUMBING

accessed by removing the cup holders. The cup holders lift up and out of the armrest. In the twin bed model there two under the curbside bed accessed by lifting the mattress. The fresh water tank drain valve is located on the front of the tank under the motorhome. The water heater drain valve or plug is located on the water heater and is accessible through the exterior water heater access door. Remove the plug or open the valve and allow water to drain. If a level surface is not available, park the motorhome facing slightly uphill until water draining ceases and then downhill until water draining ceases.

4. Follow winterizing instructions for your toilet on the preceding page of this manual.

5. While the water is draining from the systems remove, drain, and store the wet bath and the exterior shower hoses and shower heads.

6. After the water has stopped running, apply at least 60 lbs. of air pressure at the city water inlet. This can be accomplished at a service station if no air compressor is available. Air fittings with regulators can be purchased for the city water inlet. Be sure the toilet flush valve and shut off valve, all drain valves, and faucets are open and the pump outlet hose is disconnected.

7. Water pump: Remove quick connect outlet fitting from the pump and turn the pump on just for a second to pump out any remaining water from the pump

head and lines from the tank. Check the water pump strainer to be sure no water remains. There should be very little water if the tank is drained. Be sure to have a catch pan or a rag under the pump to prevent water from spilling into the RV. Leave the fittings disconnected from the pump until the system is ready to be used again. Leave a note on the water pump switch that the plumbing is not connected.

8. Remove the house batteries from your motorhome and store in a cool dry place where there is no danger of freezing. It is very important for optimum life of your battery to check it periodically and to keep it fully charged. This is especially true in winter months, when the temperature may drop below freezing. If the period of storage is for 30 days or less, you may turn off the battery disconnect switch rather than remove the battery. Continue to check and recharge the battery as needed, at least weekly in severe weather.

9. Remove any items (food, cosmetics, etc.) from the interior that might be damaged by freezing, or might damage the motorhome if containers break.

For additional winterizing protection, add non-toxic antifreeze (approved for drinking water systems) to your water lines using the following procedure:

1. Reconnect all lines except the one to the pump inlet port and close all drain valves.

2. Turn the water heater bypass valve to its bypass position. The valve is located on the back of the water and accessed through the rear doors under the curbside rear lounge seat on the rear lounge model and through and access hole cut in the roadside twin bed top on the twin bed model.

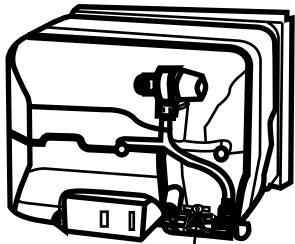

By Pass Valve

3. Attach a length of hose to the waterpump inlet port. This

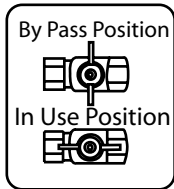

piece of hose should be long enough for the free end to be inserted into and reach the bottom of a non-toxic RV antifreeze container.

5. Check that all interior water faucets are still open.
6. Insert hose length into container containing non-toxic RV antifreeze, turn the pump on, and run the water pump until the antifreeze solution fills all water lines. Flush toilet.
7. Open exterior shower faucet until anti-freeze comes out hose, shut off valve, remove and drain valve/hose assembly.
8. Close water fixtures as the antifreeze begin to come out. Shut off pump when antifreeze has been distributed through out system, then reopen all faucets to relieve pump pressure.

9. Disconnect the hose length from pump inlet fitting and reconnect water system inlet line.

Restoring Service

1. Re-install fully charged house battery.
2. Close low point drain valves, holding tank dump valves, water faucets, and fresh water tank drain.
3. Reconnect water pump line.
4. Add water to the fresh water tank.
5. Turn water pump on.
6. Open and close faucet valves one at a time until water runs clear at all faucets signaling anti-freeze is flushed out of lines. Go back and recheck water clarity at all faucets.
7. Turn off water pump.
8. Hook up city water, open faucet valves, and recheck water clarity.
9. Replace water heater plug or close drain valve and reset water heater by-pass to the "in use" position.
10. Fill water heater.



PLUMBING

DRAIN AND WASTE SYSTEM

The drain and waste system of your motorhome includes separate grey and black tanks, remotely operated electric dump valves for each holding tank, a macerator pump, and a high pressure hose with a drip proof valve on an electric reel.

This self contained system enables you to use the toilet, sink, and wet bath until a suitable disposal facility is available.

G

The Macerator Pump

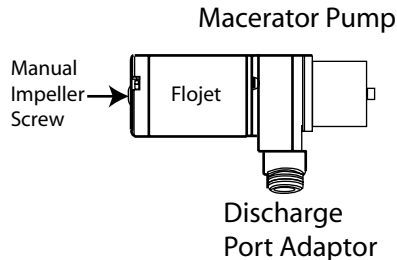

The portable waste pump is the ideal solution for emptying holding tanks on recreational vehicles and avoiding dump stations. The macerator section grinds waste down to a particle size of 1/8" maximum. The waste pump will macerate and pump all waste and tissue normally found in recreational vehicle waste systems.



CAUTION: The waste hose is pressurized when operating macerator pump. Secure loose hose end at disposal facility end with supplied inlet adaptors before turning on pump.

The high pressure waste hose is stored on an electric hose reel and connected to the Discharge Port Adaptor. It has a threaded drip proof valve with a versatile two size threaded adaptor allowing the valve to be connected to 3 sizes of threaded inlets, including an exterior home sewer clean-out. The adaptor snaps over the valve threads. A rubber ring is also provided to lodge into a non-threaded inlet. If the rubber ring seems loose when used Airstream recommends using some type of weight to further secure the hose.

Each holding tank, the macerator pump, and macerator pump electric hose reel have individual switches which are located in the roadside Utility Compartment. Pressing a dump valve switch and holding it for 2-3 seconds until it is lit opens a holding tank valve. Each valve switch has a light that comes on to let you know the valve is opened. Pressing it again for 2-3 seconds closes it. The macerator pump has an ON/OFF toggle switch. The reel has a switch for retracting the hose only, it is deployed manually.

NOTICE: Do not run pump more than 15 minutes continuously. Do not run the pump dry for more than 30 seconds. **THE MACERATOR WILL NOT**

HANDLE HARD SOLID OBJECTS, SANITARY NAPKINS OR RAGS. Never put wet strength paper towels, tissues, or sanitary napkins in your holding tank, They won't dissolve and will jam the mechanism of the dump valve and the macerator pump impeller. Colored toilet tissue is slower to dissolve than white. Most RV accessory stores offer tissue designed for RVs that will completely dissolve.

To empty the black and grey holding tanks:

NOTICE: Watch all connections while dumping, close dump valve immediately, turn off pump, and close hose drip proof valve if a leak is noticed.

1. Remove the high pressure waste hose by opening the hose reel compartment door and manually pulling out the hose. Secure the hose at the disposal facility inlet using the threaded or rubber adaptor and open the drip proof valve on the end of the hose. **IMPORTANT:** The pressure from the macerator pump may push the hose from the inlet if hose is not secured properly.
2. Open the black water valve. Empty the black tank first and the grey water tank second, using the grey water to help flush the pump and hose of black water sewage.
3. Turn on macerator pump to liquefy and pump out the solids in the tank.
4. When black tank is empty, turn off the pump.

5. Open the gray water tank valve and turn on pump. Run until just before pump runs dry. Any trickle of grey water left will remain in discharge hose behind drip proof valve and is typical. Remember, running the pump dry for more than 30 second seconds could damage the pump.
6. Turn the drip proof valve off and remove the hose adaptor from the dump station inlet, retract hose into the hose reel by pressing the reel switch located in the Utility Compartment. Be sure to guide the hose onto the reel

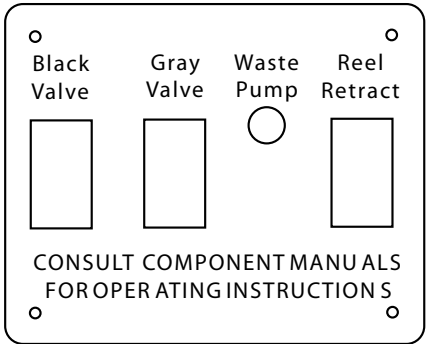
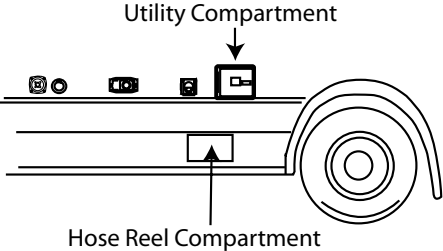

PLUMBING

evenly. Close the compartment door.

In case of electric system failure, there is a manual override on the electric dump valves located on each side of the valve. Use a flat head screw driver or an allen wrench to turn the override screw clockwise or counter clockwise according to side you access to open and close the valve. The direction is labeled on the valve.

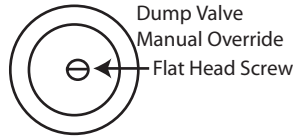

Macerator Impeller Release Feature

After long periods of non-use, a stuck impeller can be easily broken loose with a screwdriver inserted in the motor shaft slot. Remove the rubber boot, turn the shaft clockwise as shown, and replace the rubber boot.

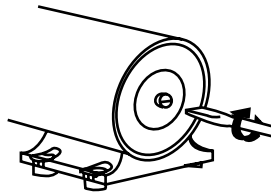

Macerator Applications

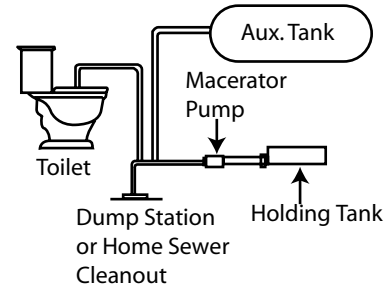

- Empty holding tanks when no dump stations are convenient.
- Transfer waste from holding tank to an auxiliary tank.
- The macerator pump can be used to empty the holding tank into any convenient sewer receiver such as a sewer clean-out at your home.

Extended Stays

When you are in a park with a disposal facility, empty the tanks every few days or whenever they become almost full. PUMPING A LARGE VOLUME OF LIQUID THROUGH THE TANKS AT A TIME WILL HELP KEEP TOILET PAPER AND OTHER SOLIDS COMPLETELY WASHED AWAY. Remember to empty the black water tank first and then the gray tank using the gray water to flush the system.

This practice will avoid the accumulation of solids in the tank, which could lead

to an unpleasant cleaning job.

Inside the Macerator hose reel utility compartment is a water hose connector for the “**black tank flush**”. To use, hook up a garden hose and turn it on full force. Within the tank a head with multiple holes will spray the interior surface of the tank. Once the tank is about half full turn the garden hose off and flush the water from the tank using the macerator pump.

Should solids accumulate, fill the tank about half full with water with the black tank flush, then drive the motorhome for a few miles. Don't wait until the tank is packed solid. The turbulence and surging of the water will usually dissolve the solids into a suspension so the tank can be drained. Draining the tanks as described will protect them from freezing during storage.

Winterizing Pump

Plan your winterizing and storage ahead and be sure the holding tanks are drained and flushed thoroughly. This is very important, as the frozen sewage and water could seriously damage the system. After dumping tanks add a quart or two of RV non-toxic anti-freeze to one of the holding tanks and start the macerator pump. Run until the anti-freeze comes out the end of the pump hose. Leave dump valves open. As extra protection, open the toilet valve and add a quart of non-toxic RV anti-freeze to the black tank and pour a quart of

non-toxic antifreeze into a sink drain to protect the holding tanks, valves, and pump from residual water freezing.

HEATED TANKS

The Interstate motorhome has 12-Volt heat pads installed with the fresh water and grey water holding tanks. The black tank is installed above the floor where heat from the furnace will keep it from freezing. The heat pads lighted switch is located on the forward shower wall just inside the sliding cargo door. The switch lights up when the pads are activated. The heat turns on at 44 degrees F. and off at 64 degrees F. The heating pads consume 6-10 amps of battery power per hour depending on environmental conditions. To conserve/charge batteries use a 120-volt source (generator, shoreline) to operate the inverter/charger. To conserve battery power or fuel in a remote location, RV antifreeze may be used to protect the tanks in freezing conditions. PLAN AHEAD. In extreme cold weather the heating pads may not suffice in keeping the tanks from freezing, be safe and winterize.

NOTICE: In very cold weather winterizing the motorhome is recommending to prevent damage to the waste systems. Use common sense and winterize as needed.

PLUMBING

Drain Systems Cleaning

There are many deodorizers on the market in tablet, liquid, and powder form. These not only combat odor, but also stimulate the bacteria that works to dissolve the solids in your tank. Picking a deodorizer with lubricating qualities will help ease the slide valve operation.

The only cleaning agents that can be used without causing harm to the system are household ammonia and tri-sodium phosphate in small quantities. Do not use any product that contains any portion of petroleum distillates. This attacks the rubber seals of your toilet and dump valves. Also, do not use any dish detergent or abrasive cleaners. All products should be marked approved for ABS drainage systems.

When winterizing the drains, use only non-toxic recreational vehicle plumbing type antifreeze. These are sold through your dealer and most outlet stores.

120-volt POWER

IMPORTANT NOTE: MAKE SURE TO READ, UNDERSTAND, AND FOLLOW ALL ELECTRICAL COMPONENT OWNER'S MANUALS PROVIDED IN THE OWNER'S PACKET BEFORE OPERATING THE MOTORHOME. Observe all operating instructions and warnings as well as all recommended maintenance schedules and procedures.

How The System Works

When you're plugged into shoreline power or start your generator, 120-volt current is fed to an Automatic Switch Over Box. Power from the box runs to the 120-volt circuit breakers on the Energy Management System. The module and box are explained more in depth later in this chapter and are located under the roadside rear lounge.

Circuit 4 can also be powered by the inverter part of the inverter/charger. See circuit 4 function in the next section for information on which receptacles can work on the inverter.

ENERGY MANAGEMENT SYSTEM (EMS)

A complete, detailed EMS manual is included with your owner's packet.



WARNING: The ENERGY MANAGEMENT SYSTEM is a centralized power switching, fusing, and distribution center. Power from the 120-volt power source is fed into the box. The potential of lethal electrical shock is present in this box. Inadvertent shorts at this box could result in damage and/or injury. All servicing of this box should be done by a qualified Service Technician.

PRODUCT DESCRIPTION

The ENERGY MANAGEMENT SYSTEM is a completely self-contained 110 volt power distribution and energy management system intended to be used in recreational vehicles. It is housed in a sheet metal enclosure with removable front panel. It provides circuit protection for all the 110 VAC loads in the RV and a system of energy management to minimize the over-loading and tripping of circuit breakers. Location: under rear lounge.



ELECTRICAL SYSTEMS

ENERGY MANAGEMENT

The ENERGY MANAGEMENT SYSTEM controls 110 volt operated circuits to help keep the total 110 volt current draw to less than 30 Amps. These circuits may be any type load, but are typically heavier loads, those whose use can be “postponed” until a time when current is available for their use.

Circuit Protection

Circuit protection for ALL the 110 VAC loads is offered by standard, resettable circuit breakers, provided by Airstream. There are four positions available for circuit breakers. These may be single or dual units. Airstream uses both single and dual breakers as needed according to the options ordered on a unit. One of these breakers (MAIN) is a 30 Amp unit that acts as the Main breaker for the entire system. The 110 volt power is brought into the box from either a shoreline outlet, generator, or the inverter can be used to feed circuit 4 only. The line side of this cable is fed through the magnetically coupled current transformer to the Main breaker. This breaker back-feeds power into the circuit breaker bus bar to feed power to the branch breakers. All the 120-volt loads in the RV are fed from the branch breakers.

The 120-volt Distribution Panel on the front of the EMS contains the main breaker and the branch circuit breakers for your RV.

The 110 volt circuits may be turned “on” by putting their breaker switch up to the on position or “off” by flipping the switch down to the off position. If a circuit is over loaded or an open (short) circuit occurs, a branch breaker will “kick” out. To reactivate the circuit, try to reset the breaker switch. To reset the tripped GFI breaker push the handle down slightly to off then lift up to on. If the breaker kicks out again, a qualified electrical service technician should trouble shoot the circuit.

Each panel is labeled with the components powered by individual circuits.

110 Volt Breaker Panel

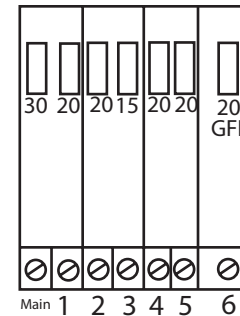

30 Amp, Main

Circuit 1. 20 Amp, roof air conditioner (option)

Circuit 2. 20 Amp , water heater

Circuit 3. 15 Amp, coffee maker (option)

Circuit 4. 20 Amp, goes through inverter to refrigerator receptacle, middle roadside receptacle, entertainment center receptacles, and main TV.

Circuit 5. 20 Amp. microwave

Circuit 6. 15 Amp. GFCI, Rear, exterior, and galley receptacles.

Main: All 110 voltage flows through this breaker to the other branch circuit breakers. Shutting off this breaker will shut down all 120-volt branch circuits fed through the panel.

Circuit 1. Roof Air Conditioner (option): Supplies power to roof A/C when option is installed. When no A/C is installed the 30-20 dual breaker becomes one 30 amp breaker. **Circuit 2. Water Heater:** 20 amp. - Water heater power supply when used as on 110 VAC.

Circuit 3. Coffee Maker: Supplies power to optional coffee maker.

Circuit 4. Refrigerator, middle roadside, and entertainment center receptacles, and main TV: This circuit goes through the Inverter/Charger. Circuit 4 can be supplied power from the inverter if needed and is protected by a GFI circuit breaker located on the Invertor/Charger as well as the breaker on the panel. Check both breakers if any receptacles or appliances on Circuit 4 does not work. Also check the middle roadside GFI receptacle and reset if needed.

This receptacle and other receptacles down stream from this GFI receptacle will not work if the GFI is kicked out.

Circuit 5. Microwave: Microwave power supply.

Circuit 6. GFI Breaker: Supplies power to the Rear, exterior, and galley receptacles.

NOTE: There are also two breakers located on the inverter/charger. One breaker protects the charger while it is charging the batteries, the other breaker protects circuit 4 in conjunction with the distribution panel breaker. This breaker for circuit 4 may trip even if the inverter is off.

NOTICE: Any time Main or AC breaker is tripped, turn AC off before resetting. Wait two minutes to restart AC.



ELECTRICAL SYSTEMS

GROUND FAULT CIRCUIT INTERRUPTER (GFCI)

Most states require trailers with exterior 110 volt receptacles and receptacles close to a water sources such as a faucet to have a ground fault circuit interrupter. When properly installed, the GFCI circuit breaker provides reliable overload and short circuit protection PLUS protection from Ground Faults that might result from contact with a “HOT” load wire and ground.

IMPORTANT NOTE: The GFCI circuit breaker will NOT reduce shock hazard if contact is made between a “HOT” load wire and a neutral wire or 2 “HOT” load wires.

Each GFCI circuit breaker is calibrated to trip with a ground current of 5 milliamperes or more. Since most persons can feel as little as 2 milliamperes, a distinct shock may be felt if the need for protection exists. However, the shock should be of such short duration that the effects would be reduced to less than the normally dangerous level. However, persons with acute heart problems or other conditions that can make a person particularly susceptible to electric shock may still be seriously injured.

While the GFCI circuit breaker affords a high degree of protection, there is no substitute for the knowledge that electricity can be dangerous when carelessly handled or used without reasonable caution.



WARNING: The GFCI circuit breaker provides protection only to the circuit to which it is connected. It does NOT provide protection to any other circuit.

GFCI s are proven lifesavers, however, consumers need to take a few minutes each month to do this simple test. By taking action, you can help protect your family from the risk of electric shock.

GFCI Breaker

Perform this test on the GFI Breaker each month and record the date on the chart.

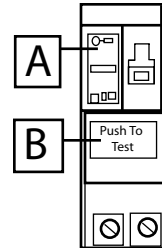

1. With handle B in “ON” position, press PUSH TO TEST button A.
2. Handle B should move to TRIP position, indicating that GFCI breaker has opened the circuit.
3. To restore power move handle B to “OFF” and the to “ON”

GFCI Receptacle

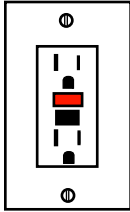

To properly test GFCI receptacles:

Push the “Reset” button located on the GFCI receptacle, first to assure normal GFCI operation.

Plug a night light (with an “ON/OFF” switch) or other product (such as a lamp) into the GFCI receptacle and turn the product “ON.”

Push the “Test” button located on the GFCI receptacle. The night light or other product should go “OFF.”

Push the “Reset” button, again. The light or other product should go “ON” again.

If the light or other product remains “ON” when the “Test” button is pushed, the GFCI is not working properly or has been incorrectly installed (miss wired). If your GFCI is not working properly, call a qualified, certified electrician who can assess the situation, rewire the GFCI if necessary or replace the device.

Record GFCI Breaker and receptacle tests in this chart

	JAN	FEB	MAR	APR	MAY	JUN	JUL	AUG	SEP	OCT	NOV	DEC
2012												
2013												
2014												
2015												
2016												
2017												

ELECTRICAL SYSTEMS

Energy Management with Three Hour Averaging

The current entering the main circuit breaker is routed through a sensor. This sensor measures the current flowing through the main breaker, which is the total amount being drawn by all the 110 volt circuits in the RV. When this current exceeds 30 Amps, the EMS will turn off the controlled loads in an effort to bring the total current to the limit of the incoming service.

The ENERGY MANAGEMENT SYSTEM limits the average current entering the Main service breaker over a three hour period to 80% of the 30 Amp service rating. Therefore, if the average current entering the main service breaker over a three hour period exceeds 80% of 30 Amps (24 Amps) the 30A Smart EMS will automatically change the service limit to 80%. Correspondingly, the 30A Smart EMS will restore the service limit to the full 30 Amp value when the average current drops below 80% of the 30 Amp rating. When the lowered service limits are enabled, the decimal point in the lower right-hand corner of the Load Meter on the Display module will be lit.

In addition the ENERGY MANAGEMENT SYSTEM feature is used when the generator is the power source to prevent the generator's circuit breaker from tripping due to an overload. The Control Module is configured to enable the feature using the configuration dip switches.

Controlled Loads

The system offers control of up to four 110 VAC powered loads. Loads that are controlled are connected to one of the relay circuits of the EMS. There are five total control relays in the EMS. Only four of these can be used in a given application.

Operation

In operation, when the 110 VAC and 12 VDC are initially applied, the system will energize the relays at one second intervals, closing the normally open contacts on each of the five relays while monitoring the total current. If the total should exceed the service limit, the system will turn off the last load that was turned on. As it does this, it calculates the amount of current that was removed, which is the value for that load. This value is placed in memory. The system has "learned" the amount of current that particular appliance draws. This feature compensates for the difference in current draw over a range of line voltage and ambient temperature, by relearning the load each time it is turned off.

The system now waits until the total current is lower than the service limit, by the amount in memory, before it will turn that load back on. This assures that there is sufficient current to operate the load.

Display Panel

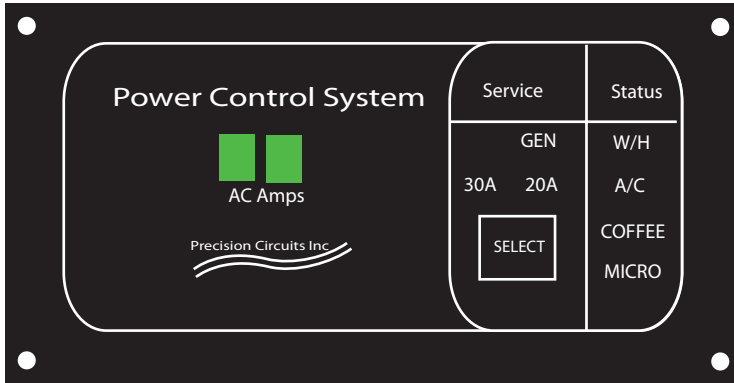

Service

The “Select” button allows the service type to be set to either 30 Amps or 20 Amps, to match the incoming service.

When power is first applied, the system will be in the 30 amp mode. The 30A LED will be ON when the system is in the 30 amp mode. Momentarily pressing the “SELECT” button will switch the system to the 20 amp mode. Momentarily pressing the button again will switch the system back to the 30 amp mode.

Press the “Select” button to switch to 20 amp service. If it is necessary to use a 20 amp adaptor such as the one pictured or you know the shoreline power is 20 amps, The 20A LED will light up.

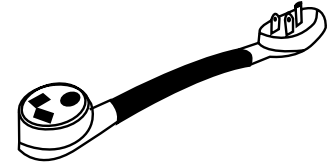

The generator supplies 20 amp service and is set to switch the system automatically to the 20 amp mode whenever the generator is the power source. The “GEN” LED will light when the generator is supplying power, the 20A light will not.

The Display Panel is protected by a 5 amp automotive type fuse located under the EMS 110 volt Distribution Panel cover. Remove the covers four screws to access the fuse.

Status

The water heater, roof air conditioner, coffee maker receptacle, and microwave are set at the factory to be the controlled circuits and are shed in this order.

This means if a power hungry electric grille is plugged into an outlet and the system begins to use more than 30 amps it will begin to shed loads and will

ELECTRICAL SYSTEMS

shut off the water heater.



WARNING: Power from the 110 volt power sources is fed into the Distribution Panel box. The potential of lethal electrical shock is present in this box. 110 VAC power from the shoreline and/or generator to the Distribution Panel must be off before removing Distribution Panel cover.

GENERATOR, LP



DANGER: MAKE SURE TO READ AND UNDERSTAND THE GENERATOR OWNER'S MANUAL BEFORE OPERATING THE GENERATOR. Observe all operating instructions and warnings as well as all recommended maintenance schedules and procedures.

The onboard generator makes your RV house electrical system fully self-contained. It allows you access to 110 volts when there is no shore power available, but keep in mind that carbon monoxide is deadly! Even though the generator is outside the living area of the motorhome to prevent fumes from entering, Never sleep in the vehicle with the genset running without testing the carbon monoxide detector. Primary protection against inhaling carbon monoxide is daily (every eight hour) inspection for visible and audible genset exhaust system leaks. Know what the symptoms of carbon monoxide poisoning are:

- Dizziness
- Vomiting
- Nausea
- Muscular twitching
- Intense headache
- Throbbing in the temples

- Weakness and sleepiness
- Inability to think coherently

If you or anyone else experience any of these symptoms get to fresh air immediately. Shut the generator down and do not operate it until it has been inspected and by a professional. If the symptoms persist seek medical attention.

DANGER: Carbon Monoxide is poisonous and can cause confusion, unconsciousness, and death. Follow all instructions, cautions, and warnings in this section and the generator operator's manual.

1. Never sleep in the vehicle with the genset running without ensuring the carbon monoxide detector is working. Primary protection against inhaling carbon monoxide is daily (every eight hour) inspection for visible and audible genset exhaust system leaks.
2. DO NOT operate the generator in an enclosed building or in a partly enclosed area such as a garage.
3. Review the safety precautions for fuel and exhaust fumes in the generator manual.
4. DO NOT operate the generator when the recreation vehicle is parked in high grass or brush. Heat from the exhaust could cause a fire in dry conditions.

5. Never operate your chassis or generator engine, or the engine of any vehicle, longer than necessary when the vehicle is parked.
6. DO NOT simultaneously operate generator and a ventilator which could result in the entry of exhaust gas. When exhaust ventilators are used, we recommend that a window on the opposite side of the unit "upwind" of exhaust gases be opened to provide cross ventilation.
7. When parked, orient the vehicle so that the wind will carry the exhaust away from the vehicle. DO NOT open nearby windows, ventilators, or doors into the passenger compartment, particularly those which can be "down wind", even part of the time.
8. DO NOT operate the generator when parked in close proximity to vegetation, snow, buildings, vehicles, or any other object could deflect the exhaust under or into the vehicle.
9. DO NOT touch the generator when running, or immediately after shutting off. Heat from the generator can cause burns. Allow the generator to cool before attempting maintenance or service.

The generator is located under the motorhome in front of the spare tire. The spare tire may have to be lowered to access the service door. See spare tire instructions in the Sprinter section of this manual.

ELECTRICAL SYSTEMS

120-volt AUTOMATIC SWITCH OVER BOX

The switch over box automatically switches the 110 volt feed to the Energy Management System Module from shoreline to generator and back as you choose which way to power the motorhome. You simply decide whether to plug into a 120-volt shoreline or start the generator and the box will do the rest. If the generator is accidentally started while plugged into shoreline the box will sense the generator incoming power, contact points inside the box will switch cutting the shoreline connection, and establishing the generator connection. This protects the system from a possible overload from dual power sources.

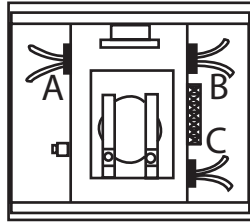

Generator/City Power

- A. To Energy Management System module main breaker
- B. From generator
- C. From shoreline

1. When plugged into shoreline power, the current path is from C to A.
2. When you start your generator, the points switch and the power flow is from B to A. Stopping the generator releases the points back to shoreline

feed.

3. If you're plugged into shoreline and you start the generator, the points still switch since the generator has the priority, so the current flow is still B to A.

12-VOLT SYSTEM

IMPORTANT NOTE: MAKE SURE TO READ AND UNDERSTAND ALL ELECTRICAL COMPONENT OWNER'S MANUALS PROVIDED IN THE OWNER'S PACKET BEFORE OPERATING THE MOTORHOME. Observe all operating instructions and warnings as well as all recommended maintenance schedules and procedures.

The major portion of electrical power in your Airstream is 12-volt. The 12-volt current powers just about every thing except for the roof air conditioner, water heater, 110 volt receptacles, and microwave oven. Even some of these appliances have electronic boards powered by 12 volt.

All 12-volt current is routed to a 12 volt pass-through power stud mounted on the battery box. The power stud is the hub of the 12 volt system. It ties together the inverter/charger, house battery, and battery separator.

Power from the stud goes to a buss bar with four breaker positions holding three Type 2 thermal breakers. The thermal breakers feed the rear lounge motor,

the tank heater pads, and the battery disconnect switch. The fourth position is left open to add a breaker for an optional solar panel. The breaker buss bar with breakers are located under the roadside rear lounge.



CAUTION: Thermal breakers break contact when overheated by a short or overload in the wiring. These breakers automatically reset when cooled down. A breaker continually overheating and breaking contact should be investigated by a qualified service technician.

Power is then routed from the battery disconnect switch to the 12-volt distribution panel, located inside the rear center lounge door, and through its branch circuits to the rest of the motorhome.

12-Volt Operation

The only thing you have to do is make sure the house battery does not run down. In normal usage, there isn't any problem, since you would normally be plugged into a 110 volt shoreline at night or when camping. When you're plugged into shoreline power or running the generator, with the battery disconnect turned to "ON" the inverter/charger charges the battery and carries much of the load.

Some nights you may not find a place to plug into city power. No problem; you can comfortably run your lights, water pump, and vents in a normal fashion

without depleting the battery.

If you are not plugged into city power, and you plan on staying longer than a day or two, you'll want to conserve your battery by using as few lights and appliances as possible. Check the monitor system regularly. If you notice the lights becoming dim, it's much easier on the battery if you go ahead and start the generator or run the chassis engine before the battery runs down. Remember the generator starts off the house battery, if the house battery becomes depleted, the chassis engine can be started to charge it. It should only take a few minutes before the generator will start.

The engine battery and house battery are isolated from each other by the Battery Separator as explained earlier, preventing the two systems from drawing down simultaneously. They will connect through the Separator if charging from the engine, generator, or inverter/charger is detected.

House Battery

The house battery (1 standard, 2 optional) in the rear lounge model is located under the curbside rear lounge in a vented battery box. The box lid is accessible through an access door in the lounge top.

The battery (1 standard, 2 optional) in the twin bed model is located under the

ELECTRICAL SYSTEMS

roadside rear twin bed. The box lid is accessible through an access door in the bed top.

Power from the battery goes to a pass through 12 V power stud mounted on the battery box.



CAUTION: When installing a battery always observe polarity.

Battery Storage

When storing your Interstate and leaving the house batteries in place it is recommended that the vehicle be plugged into a 110 volt 30 amp shoreline connection for 24 to 48 hours every 30 days. This procedure will properly maintain the battery charge and extend it's life. DO NOT leave the vehicle continually plugged in and unattended while in storage.

Battery Disconnect Switch

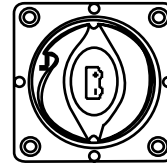

Switch On

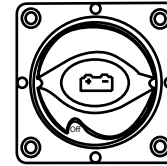

Switch Off

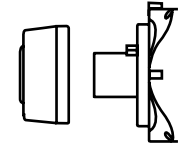

Removable Knob

The manual disconnect switch located inside the rear lounge door on the rear lounge model and on the front of the roadside twin bed on the twin bed model is used to turn off power from the battery to the 12-volt distribution panel.

Turning off the disconnect switch will cut power to 12 volt systems fed from the 12-volt distribution panel, but will allow the batteries to charge from the engine or inverter/charger.

The holding tank heat pads, the rear lounge motor, solar panel (option), and generator (option) are not connected to the 12-volt distribution panel and are wired direct through the thermal breakers mentioned earlier. The battery disconnect will not disable these systems.

The inverter/charger, the lounge motor, the tank heating pads, the generator starter, the, and the lounge motor power are not supplied through the distribution panel.

The inverter/charger and the generator start are wired direct to the house battery. Although they can be started and ran on this battery feed, the power they supply goes to the 12 volt pass through stud and the battery disconnect switch must be on for power to be supplied from these sources to the distribution panel.

The battery disconnect has a removable knob to prevent inadvertent or accidental use. To Remove Knob:

1. Rotate the knob to the off position, The knob is still locked to the switch.
2. Depress and continue to rotate anti-clockwise until the stop is reached.
The knob can now be removed by pulling it straight out.

To replace Knob: Place knob in the switch housing. Depress and turn clockwise 45° to the off position.

NOTE: As a safety precaution the electric gas shut-off solenoid closes automatically when 12-volt power is disconnected, cutting gas to appliances. It will reopen when power is restored.

Battery Separator

The Battery Separator is located under the center lounge on the rear lounge model and the roadside bed on the twin bed model and is accessed by opening the rear cargo doors. It is designed as a solenoid priority system to protect the chassis charging system from excessive loading while allowing house batteries to be charged. The Battery Separator has two basic uses:

Protect The Charging System

The Battery Separator monitors the battery system to determine if the batteries are being charged. The charging can be accomplished through the inverter/charger or the engine charging system. When the engine battery or house batteries are charging, the Battery Separator will engage, joining the two battery banks. If charging ceases and voltage decreases in either bank the Battery Separator will disconnect the two banks from each other, protecting the banks from being discharged simultaneously.

NOTE: In the event the engine battery is depleted, Sprinter recommends using a trickle charge only when charging the battery. When jumping the engine battery do not use a power boost.

Please read and follow battery charging procedures in the Sprinter Owner's manual.

ELECTRICAL SYSTEMS

Inverter/Charger

Tripp Lite's RV750ULHW Inverter/Charger is a DC to AC inverter and a 45 amp multi-stage battery charger. It has a Remote Control Module mounted in the roadside rear roof locker.

The Inverter/Charger charges the batteries and converts 12 VDC to 110 VAC current for distribution to circuit 4 in the 120-volt distribution panel. Circuit 4 is explained in the 120-Volt Power section earlier.



WARNING: AN EXTENSIVE OWNER'S MANUAL FOR THE INVERTER/CHARGER IS PROVIDED IN THE AIRSTREAM OWNER'S PACKET. MAKE SURE TO READ, UNDERSTAND, AND FOLLOW ALL INFORMATION, CAUTIONS, AND WARNINGS IN THE MANUAL BEFORE OPERATING THE INVERTER/CHARGER.

Engine Start Assist

An auxiliary start assist button is located on the dash just below the headlamp switch. If for some reason the chassis battery runs low, pushing and holding this button while turning the ignition key will supply power from the coach batteries to the engine starter. Release the button when the engine starts.

ELECTRICAL SYSTEMS

12-Volt Distribution Panel Diagram

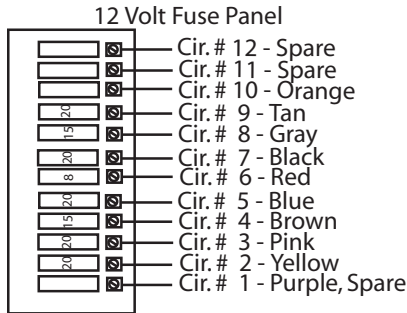

CIRCUIT 1: UNUSED ON REAR LOUNGE MODEL
5 AMP, EMS SYSTEM ON TWIN BED MODEL

CIRCUIT 2, 20 AMP YELLOW

RECESSED CEILING LIGHTS
PATIO LIGHT
AISLE LIGHTS

CIRCUIT 3, 20 AMP, PINK

GALLEY LIGHTS
WATER PUMP
WATER HEATER (SWITCH LIGHT ONLY)

CIRCUIT 4, 15 AMP, BROWN

FLIP DOWN TV
ENTERTAINMENT CABINET 12 V JACK/BOOSTER

CIRCUIT 5, 20 AMP, BLUE

BATH CEILING VENT
MAIN AREA CEILING VENT
LOUNGE READING LIGHTS
FURNACE & THERMOSTAT
AC & THERMOSTAT (OPTION)
ENERGY MANAGEMENT DISPLAY MODULE

CIRCUIT 6, 8 AMP, RED

REFRIGERATOR POWER
LP DETECTOR
LP GAS VALVE
MONITOR PANEL

CIRCUIT 7, 20 AMP, BLACK

EXTERNAL 12V RECEPTACLE
GRAY HOLDING TANK DUMP VALVE
BLACK HOLDING TANK DUMP VALVE
EXTERIOR SEWER LIGHT

CIRCUIT 8, 10 AMP, GRAY

RADIO POWER RELAY
ROPE LIGHTS
BATTERY SEPARATOR

CIRCUIT 9, 20 Amp, TAN

WASTE PUMP MACERATOR

CIRCUIT 10, 2 Amp, ORANGE

MACERATOR PUMP HOSE REEL

Switch and Component Locations

FRONT SHOWER PANEL:

Main ceiling lights
Bath ceiling lights
Aisle lights
Patio light
Lighted tank heat pad switch (fresh and grey water)
Step extend disable switch

ELECTRICAL SYSTEMS

UNDER GALLEY ROOF LOCKER:

- Rope lights
- 3-Gang switch
 - Galley lights
 - Galley reading lights
- 1-gang switch
 - Water pump

FRONT ENTERTAINMENT CABINET:

- 12 V TV jack/booster
- 2 Audio video hookups (3-position)

SWITCHED INDIVIDUALLY:

- Shower vent
- Ceiling vent
- Reading lights (main switch must be on to operate)
- Flip down TV light (will work off chassis dome light also)

EXTERIOR ROADSIDE WALL SWITCH BOX

- Gray tank dump valve switch
- Black tank dump valve switch
- Macerator pump switch
- Macerator hose reel switch

INSIDE CURBSIDE ROOF LOCKER:

- Monitor panel display
- Inverter remote switch
- Generator remote switch
- Energy management system display
- Water heater switch/display

LP VALVE SWITCH & REMOTE FILL behind the passenger side rear fender.

HEAT/AC THERMOSTAT on wardrobe wall.

EXTERNAL 12V RECEPTACLE is on the roadside exterior wall.

RADIO POWER RELAY is behind removable radio. The automatic relay allows the radio to be played while in transit off the engine battery or by the house battery while camping or for up to 30 minutes after the key has been removed from the ignition.

POWER AWNING (option) SWITCH is located on the passenger seat pedestal, the sliding cargo door must be closed during deployment. Awning will retract but won't extend while vehicle is running.

REAR VIEW CAMERA (option) CONTROLS are on the add on rear view mirror/

monitor. The camera turns on automatically when in reverse or can be turned on manually with the switch on the mirror/monitor to view in transit. Please disregard the Bluetooth Connected/Disconnected pop up message when the monitor turns on and the Bluetooth No Connection message whenever the monitor moves out of standby mode. They will go off after about 15 seconds. See monitor owner manual included in your Owner's Packet for operation and Bluetooth hook up information.

Auxiliary Fuse Locations

In addition to the 12-volt fuses and breakers described in the this section, some components have additional fuse protection as supplied or required by their manufacturer.

Locations:

1. LP detector: 1.2 amp fuse behind detector.
2. Battery Separator power line to engine battery: 125 amp inline fuse inside Sprinter battery compartment under driver's floorboard.
3. Monitor panel battery voltage display: Sprinter battery compartment on fuse power distribution bar under driver's seat. (5 amp)
4. Inverter: 125 amp inline fuse under rear lounge or roadside bed by inverter/charger.

5. Dash radio: 10 amp fuse on back of radio.
6. Rear view camera (option): 1.5 watt inline fuse behind antenna booster.
7. Thermostat display: Fused to 5 amp breaker on front of furnace.

Monitor Panel

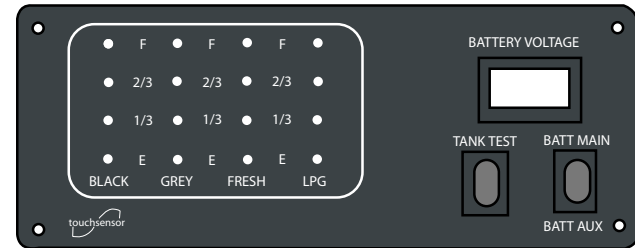

TouchSensor Technologies, LLC

Phone: 630.221.9000

<http://www.touchsensor.com>

The monitor display panel shows the fluid levels of the Black, Grey, and Fresh water tanks, and the Liquid Propane gas tank. Push the Tank Test rocker switch to tank fluid show levels in 1/3 increments.

The panel also shows the voltage status of the Main (engine) and the Auxiliary (house) battery by using a labeled rocker switch.

ELECTRICAL SYSTEMS

The fluid tank monitor system has been calibrated at the TouchSensor factory for the size tanks the Interstate uses and should never need another calibration. On the rear of the monitor panel there is an adjustable potentiometer to manually adjust the monitor panel reading of the LPG tank level, this is set at the Airstream factory for the tank on the Interstate motorhome and needs no further adjustment.

ENTERTAINMENT SYSTEM

Antenna Manufacturer:

Winegard Company

3000 Kirkwood Street

Burlington, Iowa 52601-2000

Phone: 800-843-4741

Winegard's Model RS 3460 RoadStar™ omnidirectional antenna provides excellent reception of VHF/UHF TV channels. The RoadStar compact modern styling is unobtrusive and blends well with the designs of recreational vehicles.

The UV stabilized copolymer housing makes the antenna virtually impervious to weathering and color change. The unique omnidirectional characteristics of model RS-3460 provide excellent reception in areas where stations are in different directions without the need for a complex rotor system. A built-in

amplifier provides up to 6 times the received signal on VHF and 9 times the UHF signal insuring the best possible reception in color and black and white.

Cleaning Antenna Housing

The surface of the antenna is a tough laminated ultraviolet shield. Clean only with mild soap and water. Use no solvents, alcohol, or cleaning fluids.

In-Motion TV Antenna Pre-Wire

The motorhome is pre-wired with a coax cable for an in-motion TV antenna. One end of the cable is coiled above the rear center roof locker, coiled above the removable interior top panel and the other end is coiled behind the removable entertainment cabinet side panel where the TV booster is mounted. A receiver can be placed inside the cabinet. A HDMI cable is located in the center rooflocker and runs to the rear or wardrobe TV.

Listed below are components located inside the Entertainment Cabinet and their functions.

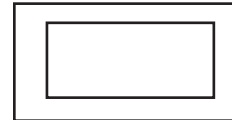

An outlet blank is installed in the cabinet. The blank has a 110 VAC circuit wire looped in it for installation of an outlet.

TV OUTLET W/AMPLIFIER AND 12 VOLT

OUTLET Provides an inlet for a television and activates the antenna booster. The 12-volt power outlet provides 12-Volt power to appliances.

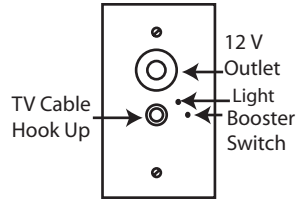

SATELLITE ANTENNA WIRING AND HOOK UP

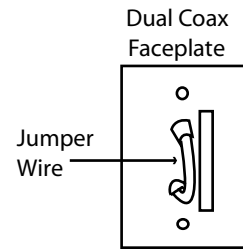

The Interstate Motorhome has a faceplate with two coax cable hook-ups. It is located in the Entertainment Center Cabinet. The faceplate has a small coax cable jumper running between the hook-ups to complete the cable TV circuit when in use. To install a satellite system use the following procedure:

1. Remove the jumper wire from the dual coax faceplate.
2. Connect a portable dish into the Cable TV receptacle on the exterior of the motorhome. This feeds the dish signal to the input side of the faceplate.
3. Install the satellite receiver input and output into the dual coax faceplate.

To return to a cable TV system, remove the satellite receiver from the faceplate and reinstall the jumper cable. Hook a cable feed to the exterior inlet.

TELEVISIONS (Optional)

User guides are provided for the televisions installed in your motorhome.

UHF/VHF RECEPTION

To operate on the amplified antenna press the switch located on the faceplate so the small red light beside the switch comes on. The switch activates the booster for the TV antenna on the roof. To check operation simply tune a TV to channel receiving reception and switch the booster on and off to see if reception improves

CABLE RECEPTION

To operate on the TV cable system, turn the booster off, make sure the jumper wire is installed on the dual coax face plate, and run a cable TV provider coax to the exterior cable TV/Satellite inlet.

ELECTRICAL SYSTEMS

Televisions are mounted on articulating arms to provide different viewing angles. Travel locks on the arms should be engaged before travel. On the twin bed model the articulating arm is released by a cord with ring on it. The cord is accessed through a hole in the panel below the television.

RADIO

The radio system is supplied by the chassis manufacturer and is serviced and warranted by the chassis authorized service locations. Instructions for the radio system are supplied in the chassis owner's packet.

Solar Panel Pre-Wire

The Interstate Motorhome is pre-wired for the addition of a solar panel of your choice and a Cat-5 cable has been included for a display panel used for the installation of the Carmanah Technologies panel Airstream uses for the solar panel option on the Interstate motorhome.

Locations for solar panel pre-wire:

- * A green and a yellow wire are accessed by removing the entertainment cabinet roadside inside top panel. These wires are fed up through the roof and connect to the solar panel.
- * The green wire is run to the ground buss bar on the 12-volt distribution panel.
- * The yellow wire is coiled beside the four position breaker buss bar located under the curbside rear lounge. One position is left open to add a Type 2 thermal breaker for the solar panel protection. Refer to the panel installation manual for instructions.

Solar Panel (option)

This system may be installed on your trailer as an option. A manual on the use of the system is included with the Airstream Owner's Blue Delivery Case.

1. A YELLOW (like the sun) positive lead runs from the solar panel to a breaker in the battery breaker buss bar under the curbside side dinette seat, third position. This bar is connected to the house battery. A GREEN (like the earth) negative lead runs from the solar panel to the chassis ground.
2. A Cat 5 patch cord for the solar panel display runs from the solar panel to the charge controller located under the curbside dinette seat.

The charge controller senses the actual battery charge and regulates the charging to prevent over charging. The system requires the 12 volt feed from the battery to operate.

Please see the solar panel manual for further information.

Battery Assist

Some models are equipped with a battery assist switch located on the lower dash to the left of the steering wheel. This feature will assist in starting a vehicles engine if the starting battery runs low.

To use:

1. Push and hold the labeled Battery Assist button for 30-40 seconds.
2. Continue to hold the button while tuning the ignition switch to start.
3. Release button after engine starts.



ELECTRICAL SYSTEMS

NOTES





WARNING: Most LP gas appliances used in recreational vehicles are vented to the outside of the vehicle. Check the exterior areas of your unit for clearance in these areas. Turn all gas operated appliances off when parked close to a gasoline pump, it is possible that gasoline fumes could enter these types of appliances and ignite from the burner flame or automatic igniters, **CAUSING A FIRE OR AN EXPLOSION.**

If any appliance manuals have not been provided with your motorhome, contact your dealer, the respective appliance manufacturer or Airstream Customer Service. A manual will be provided to you.

Maintenance: Follow the instructions and warnings noted in the appliances and equipment owner's manuals as well as the ones listed below:

- Annual maintenance should be conducted on propane gas appliances and equipment by an authorized dealer or repair facility.
- Insects can build nests in the burners of various appliances and equipment. The burner and burner orifice of the propane gas appliances and equipment should be cleaned out by an authorized dealer or repair facility anytime circumstances or conditions warrant, but no less than on an annual basis.

AIR CONDITIONER

Manufacturer:

Carrier Tranport/Air Conditioning

50 Grumbacher Road

York, PA 17402

Phone: 800-673-2431

Note: Review the air conditioning literature supplied in your Owner's Packet before proceeding,

The roof air conditioner used on the motorhome is one of the most popular on the market today. In your Owner's Packet is a set of literature covering all operating and maintenance instructions. If the literature is misplaced please contact the air conditioner manufacturer or your Airstream dealer for replacement.

The voltage to the air conditioner is critical. We commonly refer to 110 or 120 volts, but a check with a voltmeter may find voltage much lower. Your air conditioner will probably not function if the current drops below 105 volts. Low voltage is usually associated with older or poorly maintained trailer parks, but many people have found their homes, built only twenty or thirty years ago, may not be capable of operating the air conditioner on some receptacles,

APPLIANCES

Parking your motorhome so the power cord can be plugged into a receptacle close to the fuse or circuit breaker box can alleviate the problem. Avoid extension cords and adapters whenever possible. If an extension cord must be used it should be as short and heavy as possible to provide the most current to the air conditioner.

If high temperatures are expected, make an effort to park in a shaded area. Starting the air conditioner early in the morning also helps. It is much easier to hold a comfortable temperature than it is to lower the temperature after the interior of the motorhome is already hot.

FURNACE

Manufacturer:
Atwood Mobile Products
1874 South Pioneer Road
Salt Lake City, UT 841041
Phone: 801-972-4621

The manufacturer of the furnace in your motorhome has been well known in the RV industry for many years. The furnace burns LP gas, and is powered by 12-volt current from the battery. Operating instructions are located in your Owners Packet. If they should become misplaced new literature can be ordered direct from the manufacturer or your Airstream dealer. The manufacturer also offers a detailed service guide for your furnace.



WARNING: Carefully read all the manufacturer's instructions prior to operating. NEVER store flammable material next to the furnace or around its exhaust vent on the side of the motorhome. Before starting the furnace, check and clear all obstructions from exterior vent area.

If warranty service is required use only a service location recommended by the furnace manufacturer or a qualified Airstream dealer.

REFRIGERATOR

Novakool, 3.1 Cu. Ft.
Model R31000AC/DC

Manufacturer:

Nova Kool Manufacturing Inc.
1578 Hartley Avenue
Coquitlam, BC
Canada V3K 7A1

Novakool service department can be reached at 604-523-6515 ext. 104, or at support@novakool.com from 7:00 am to 5:00 pm PST.

Review all refrigerator Literature supplied in your Owner's Packet or stored in the refrigerator prior to operating.

OPERATION

The refrigerator requires 12-volt or 120-volt current to operate. It is equipped to automatically switch between the sources as needed with 120-volt taking priority when both sources are available.

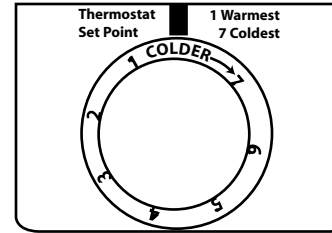

All Nova Kool units are supplied with a wide range thermostat that is designed to sense the evaporator (cold plate) temperature. The coldest position on the thermostat is reached by turning the knob to the right (clockwise); conversely turning the thermostat knob to the left (counterclockwise) yields a warmer set-

ting. The OFF position is reached by turning hard counterclockwise past the click. The reference point is shown with an indicator sticker beside the knob.

Start-up:

Turn the power on and set the thermostat between 3 and 4. You can make further adjustments to suit your personal requirements after the box has cooled down. Allow the refrigerator to come down to temperature before loading with product. Adding pre-cooled product will help keep the temperature stable when loading. Setting the thermostat to a higher setting i.e. 7, will not decrease the time required for the unit to cool down to its normal operating temperature. The unit will cool at the same rate on DC as on AC.

APPLIANCES

Defrost & Cleaning:

The frequency of defrost is dependant on the number of door openings, the ambient temperature and the humidity level. Typically, it is a good practice to defrost once there is ¼" of frost buildup on either side of the evaporator (cold plate). When defrosting, the unit is shut off at either the breaker panel or by turning the thermostat counterclockwise to the OFF (0) position. Prop the door open. We suggest placing a towel in the bottom of the refrigerator to catch excess moisture. Speeding up the process with a knife or scraper is strongly discouraged due to the likelihood of rupturing the refrigerant circuit; in the event this happens give us a call 604-523- 6515 ext.104.

Now that the unit has been defrosted, the interior can be cleaned with a non-abrasive cleaner. Do not use "brillo" or "sos" type abrasive pads, as they will score the surfaces. Baking soda is recommended.

COOK TOP

Smev Series 8022

People using a cook top in their home will find little difference in the operation of the cook top in a recreation vehicle. Other customers, used to electric ranges may be a little apprehensive at first; but will quickly gain confidence. The basic

operation of the gas cook tops have been the same for many years, but please be sure to read all the directions furnished by the manufacturer and located in the Owner's Packet. Excellent service and parts manuals are also available from the manufacturer.



WARNING: The operation manual for the cook top contains specialized information, warnings, and cautions that if not followed exactly, may result in a fire or explosion causing property damage, personal injury, or death. The manual should be reviewed prior to operating the appliance. If this manual has not been provided with your motorhome, contact your dealer or Airstream Customer Service to obtain it.



WARNING: The cook top operates on liquid propane gas and is designed to cook foods only. Any other use is considered incorrect and dangerous. Airstream Inc. and SMEV are not responsible for any personal injury or property damage due to improper, incorrect, or irresponsible use.

IMPORTANT: This appliance must only be used by responsible adult people. During and immediately after use accessible parts may be hot; do not touch them and keep children away. Once cooking is completed, ensure that all gas control knobs are turned to the closed position. After use turn off the gas

at the main supply. Caution: glass lids may shatter when heated. Turn all the burners off before closing the lid. Cooking facilities must not be used to heat the environment. Keep combustible materials away from the appliance. Use protection gloves when handling hot elements. Never lay Pyrex lids or other items on the burners.

USE THE APPLIANCE ONLY IN A WELL VENTILATED SPACE. The use of a gas cooking appliance results in the production of heat and moisture in the motorhome. Use the ceiling vents to ensure that the motorhome is well ventilated.

Choose the burner suitable for the pan dimensions making sure the burner flame does not extend beyond the pan base (Fig. 2). Place the pan centrally on the burner so that it is stable on the pan support.

Figure 2

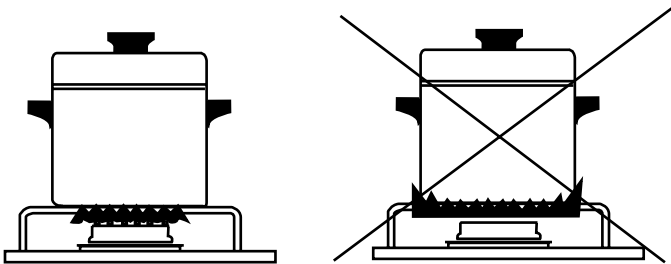

IMPORTANT: NO PANS OR OTHERS OBJECTS MUST BE OVER THE BURNERS DURING IGNITION OPERATION.

AUTOMATIC HOTPLATE IGNITION:



WARNING: The cook tops glass lid must be in the up position before lighting burners.

- a) Push control knob in slightly, turn to ignition position (Large flame symbol). Ignite the burner by pressing the ignition button, keep the control knob pressed in for 3-5 seconds.
- b) Release knob and turn to the required heat setting (large or small flame symbol). The flames internal tongue should be blue and the outline well defined.

IMPORTANT: IF THE BURNER DOES NOT IGNITE IMMEDIATELY, TURN THE KNOB TO “MINIMUM RATE” POSITION AND REPEAT THE OPERATION.

If ignition is still not possible have the appliance checked to ensure that there is gas and/or electrical supply. If the unit still fails to ignite turn the gas off at the main supply and contact your dealer.

CLEANING INSTRUCTIONS. Turn off the appliance and allow to cool be-

APPLIANCES

fore cleaning. Cold water or a damp cloth may damage hot surfaces. Do not use abrasive, corrosive, chloride-based products or steel pads. Do not leave acidic or alkaline substances e.g. vinegar, salt, lemon juice etc. on the appliance surfaces. Stainless steel surfaces and enamelled parts should only be washed with soapy water or neutral detergent, rinsed and dried. Only use clean sponges or cloths.



WARNING: Do not cook while under way. Hot food or liquid could scald due to a sudden stop or accident.

MICROWAVE OVEN

Please read all the directions furnished by the manufacturer and located in the Owner's Packet. Only federally certified technicians are permitted to service microwave ovens. If you have a microwave problem please contact your dealer or Airstream Customer Relations department.



WARNING: Do not cook while under way. Hot food or liquid could scald due to a sudden stop or accident.

WATER HEATER

Manufacturer:
Atwood Mobile Products
6320 Kelly Willis Road
Greenbriar, TN 37073
801.972.4621

Note: Review the water heater literature supplied in your Owner's Packet before proceeding to use the water heater, It contains important operational, maintenance, and safety information.



WARNING: Hydrogen gas can be produced in a hot water system served by this heater that has not been used for a long period of time (generally two weeks or more). Hydrogen gas is extremely flammable. To reduce the risk of injury under these conditions, it is recommended that the hot water faucet be opened for several minutes at the kitchen sink before using any electrical appliance connected to the hot water system. If hydrogen is present, there will probably be an unusual sound such as air escaping through the pipe as the water begins to flow. There should be no smoking or open flame near the faucet at the time it is open.

Water Heater Draining

All models have a drain plug or pet cock on the water heater. Access is from the exterior. The plug or valve is usually located in the lower left corner, viewed as you face the exterior of the water heater.

SAFETY

If your water system is full and cold and the water heater is ignited, the system can produce pressures as high as 120 psi before the relief valve starts to open. Since the water system normally operates in the 40-psi range the water expansion does put unusual stress on the system. This normally does not cause any problems, but the stress is easily alleviated. As the water is heating just open any faucet and run as little as a cup of water. Just removing this small amount of water reduces the pressure build up significantly.

For fun, watch the sequence of events your family goes through when you park the motorhome and ignite the water heater. More than likely, someone will run water and relieve the pressure without even realizing it.

SPECIFICATIONS

NOTE: The weights and measurements in this manual are derived from the best information available at time of this manual's publishing. Please refer to the Cargo Carrying Capacity tag placed on the inside of the door and your Sprinter Owner's Manual for weights specific to your RV.

DIMENSIONS	Twin Bed	Rear Lounge
Exterior Height with Antenna (Estimated)	9' 7"	9' 7"
Interior Head Room	74.25"	74.25"
Interior Floor Width at Floor	70"	70"
Exterior Length	22' 9"	22' 9"
Exterior Width	79.7"	79.7"

CAPACITIES/WEIGHT RATINGS	Twin Bed	Rear Lounge
LP Tank @ 78% Full	14 gal.	14 gal.
Fresh Water Tank	26 gal.	26 gal.
Grey Tank	27 gal.	27 gal.
Black Tank	16 gal.	16 gal.
Water Heater	6 gal.	6 gal.
Fuel Tank, Diesel	26.4 gal.	26.4 gal.
GVWR (lbs.)	11,030	11,030
GCWR (lbs.)	15,250	15,250
TWR, Maximum (lbs.)	500	500
GTW (lbs.)	5,000	5,000
GAWR-FRONT (lbs.)	4,080	4,080
GAWR-REAR (lbs.)	7,720	7,720

SCWR (lbs.) - Sleeping Capacity	2 (300 lbs.)	2 (300 lbs.)
Seating Capacity (Traveling)	3 (450 lbs.)	8 (1200 lbs.)
Seating Capacity (w/Lounge Wardrobe)	3 (450 lbs.)	7 (1050 lbs.)
NCC (lbs.)	2,974	2,897
UBW (lbs.)	8,056	8,133

Abbreviations are defined on the next page.

Wheel Torque Specification:

Steel Wheels: 133 Lbf/ Ft. + or - 14 Lbf. /Ft.

Aluminum Wheels: 140 Lbf/Ft.



WARNING: The towing vehicle's braking system is rated for operation at GVWR (GROSS VEHICLE WEIGHT RATING), NOT at the GCWR (GROSS COMBINED WEIGHT RATING). A separate functioning brake system is required for any towed vehicles or trailers weighing more than 1000 lbs. (450 kg) when fully loaded. NEVER exceed the GVWR (GROSS VEHICLE WEIGHT RATING), or the GAWR (GROSS AXLE WEIGHT RATING) specified on a motorhome certification label.



WARNING: Do not exceed the Gross Axle Weight Ratings, the Gross Vehicle Weight Rating, or the Gross Combined Weight Rating when loading your vehicle and/or towing a trailer. Failure to heed any part of this warning could result in loss of control of the motorhome and towed

vehicle or trailer and may cause an accident and serious injury.



WARNING: READ AND FOLLOW ALL WARNINGS IN THE FUEL SECTION OF YOUR SPRINTER'S OPERATOR'S MANUAL BEFORE FUELING YOUR VEHICLE.



WARNING: NEVER exceed the weight ratings of the trailer hitch installed on a motorhome. Failure to heed any part of this warning could result in loss of control of the motorhome and towed vehicle or trailer and may cause an accident, serious and/or fatal injury. For specified towed vehicle braking requirements, consult the Sprinter owner's manual.

Abbreviation Definitions

- Gross Vehicle Weight Rating (**GVWR**) is the maximum permissible weight of the motorhome.
- Gross Combination Weight Rating (**GCWR**) means the maximum allowable loaded weight of this motorhome and any towed trailer or towed vehicle.
- Tongue Weight Rating (**TWR**) is the maximum permissible weight of the trailer tongue on the hitch.
- Gross Trailer Weight (**GTW**) is a maximum permissible trailer weight to be towed on the hitch.
- Gross Axle Weight Rating (**GAWR**): is the value specified as the load

carrying capacity of a single axle system, as measured at the tire-ground interfaces

- Sleeping Capacity Weight Rating (**SCWR**) is the manufacturer's designated number of sleeping positions multiplied by 150 pounds (70 kilograms).
- **Seating Capacity** (Traveling); is the maximum number and maximum total weight of passengers allowed to ride in the vehicle while in transit as determined by the availability of seat belts and weight.
- Net Carrying Capacity (**NCC**) is equal to GVWR minus UBW.
- Unit Base Weight (**UBW**) is the dry weight of the base unit with full fuel and w/o options or fluids.

NOTE: The Unit Base Weight (UBW) and the Net Carrying Capacity (NCC) is not the same as the Unloaded Vehicle Weight (UVW) and the Cargo Carrying Capacity (CCC) shown on the Motorhome Weight Information tag in your vehicle. The UBW and NCC weights are for the base unit with no options and fluids except for fuel on motorhomes.

The UVW and CCC on the Cargo Carrying Capacity tag are weights for the individual vehicle as built with its options and certain water capacities.

INDEX

Air Conditioner	I-1	Component Identification.....	C-1	Gas, LP.....	G-1
Alignment,	C-3	Condensation	D-17	Generator	H-8
Antenna	H-18	Cook Top	I-4	Ground Fault Interrupter.....	H-4
Appliances.....	I-1	Counter Areas	F-5	GVWR.....	B-1, J-1, J-2
Awning.....	E-8	Curtain, Front Privacy.....	F-9	GCWR	B-5, J-1, J-2
Bathroom.....	F-14	Dimensions.....	J-1	Hitch Load	B-6
Battery Box.....	B-14, H-11	Dinette	F-2	Holding Tanks.....	G-14
Battery Disconnect.....	H-12	Drain/Shutoff Valves	G-8, G-11	Humidity	D-17
Black Tank Flush	E-5, G-17	Driving	B-6	 	
Body Kit.....	H-3	 		Interior	F-1
Breaker Panel, 120-volt.....	H-3	Electrical System.....	H-1	 	
Bulbs, Interior	F-8	Entertainment System.....	H-18	Jack	C-10
 		Extended Stay	D-16	 	
Cab Seats.....	C-2, F-1	Exterior	E-1	Leveling	C-14, D-16
Cabinets	F-2	Exterior Shower.....	G-7	Lights, Interior	F-7, H-15
Camping.....	D-1	 		Loading.....	B-1
Capacities.....	J-1	Faucets.....	F-3	Lounge/Bed.....	F-1
Carbon Monoxide.....	D-9	Fabrics, Cleaning.....	F-4	LP Gas Detector	D-14
Chassis, Sprinter Van	C-1, J-1	Fire Safety	D-8	LPG System	G-1
Circuit Breakers.....	H-2, H-10	Flooring	F-2		
City Water Hook-Up	G-6	Furnace	I-2		
Cleaning, Aluminum Skin	E-1, F-4	Fuses	H-15, H-17		

INDEX

Maintenance Schedule.....	A-9	Smoke/CO Alarm	D-2	Towing A Trailer	B-6
Macerator Pump.....	G-14	Solar Panel Pre-Wire	H-20	Towing Your Motorhome	B-14
Microwave Ovens.....	I-5	SpareTire	C-9	TV Antenna	H-18
Mold	D-18	Specifications	J-1		
Monitor Panel	H-17	Storage.....	B-1	Vent, Power	F-6
		Switch Over Box.....	H-10	Ventilation	D-17
Overloading	B-1, B-6			Washing/Waxing.....	E-1
Overnight Stop	D-15	Tank Capacities	J-1	Warranty	A-1
		Tank Drain, Fresh Water	G-8	Water Heater	I-6
Plumbing	G-1	Tank, Holding.....	G-14	Water Heater By Pass	G-13
		Tank, Water.....	G-4	Water Hookup	G-6
Refrigerator.....	I-3	Tank, LPG	G-1	Water Pump & Strainer.....	G-5
Roof Vent.....	F-6	Tires.....	C-3	Water System	G-4
		Air Pressure	C-3	Water Valves.....	G-8, G-11
Safety Defects, Reporting	A-8	Alignment.....	C-3	Weighing.....	B-2
Safety	B-4, B-15	Changing	C-7	Weight Distribution	B-4
Sanitizing, Fresh Water Tank	G-7	Inflation.....	C-4	Wheels.....	C-12, C-15
Seats	F-1	Overloading	C-5	Wheel Simulator	C-10
Seat Belts	B-4	Torque.....	C-6, C-13	Wet Bath.....	F-3
Service.....	A-7	Rotation	C-14	Winterizing.....	G-11
Shades	F-5	Spare	C-9	Winter Traveling.....	D-19
Shower/Wet Bath	F-3	Support.....	C-14		
Sinks.....	F-3	Toilet	G-8, G-10	Airstream Interstate Owner's Manual	
				© Airstream, Inc. 2012	