

This Owners Manual has been prepared to help you use and enjoy your new European specification Airstream to the full, from the first time you take it on the road.

Many European Airstream customers are new to towing and possess limited experience of trailer systems. For this reason this manual sets out information in the order you will need to assimilate it.

First we set out the information you need when choosing your Airstream and matching it with a suitable tow car, then at the time of the handover/ your first journey. Subsequent sections guide you step by step through the procedures for departure & arrival, explain how to plan maintenance and how to operate the systems and appliances.

You also need to read and refer to the appliance manufacturer's manuals contained in your Owner's Pack. Keep these to hand in the Airstream, with this manual.



Throughout this manual **! CAUTION** and **! WARNING** notations are used. Failing to observe **! CAUTION** can damage equipment. **! WARNING** highlights the possibility of personal and/ or fatal injury if not observed.

Enjoy your new Airstream!

Notes: All information, illustrations and specifications in this Manual are based on the latest product information available at the time of publication approval.

If and when new materials and production techniques are developed which can improve the quality of its product, or material substitutions are necessary due to availability, Airstream reserves the right to make such changes.

© Airstream INC. Reproduction of the whole or part of this Manual without permission is prohibited.

Contents

	<u>Reference</u>		<u>Reference</u>
A		E	
Outfit matching		Chassis, axle & running gear	
Trailer dimensions	A1	Overview	E1
Trailer weight	A2	Hitch & coupling	E2
Towcar weight & suitability	A3	Coupling & hitch head	E3
Towcar and trailer combined weight	A4	Jockey wheel	E4
Towing equipment	A5	Brakes	E5
		Suspension	E6
		Tyres	E7
		Spare wheel & jacking	E8
		Wheel changing	E9
		Maintenance	E10
		Components & tyre pressures	E11
B		F	
Before/ at handover		Electricity	
Towing safety advice	B1	EC325 schematic	F1
Fire	B2	EC155 schematic	F2
Ventilation	B3	Normal operation	F3
Children	B4	EC325 Power Control System	F4
Insurance	B5	EC325 – 12v fuses	F5
Security	B6	EC325 – digital control panel	F6
Warranty	B7	EC155 Power Control System	F7
		EC155 – 12v fuses	F8
		230v fuses	F9
		Troubleshooting	F10
		More information	F11
C		G	
Departure & arrival		Water	
Packing lists	C1	Overview – cold water & waste water systems	G1
Loading	C2	Normal operation	G2
Actual laden weight & nose weight	C3	Equipment	G3
Hitching up	C4	More information	G4
Departure checks	C5	Priming, draining, maintenance	G5
Arrival	C6	Troubleshooting	G6
Travel abroad	C7		
D			
Maintenance			
Modifications	D1		
Cleaning the exterior	D2		
Maintenance Schedule	D3		
Annual Service	D4		
Autumn Frost Protection	D5		
Winterising	D6		
External lighting	D7		

	<u>Reference</u>		<u>Reference</u>
H Gas		L Awnings	
Overview	H1	Zipdee patio awning	L1
Normal operation	H2		
Further information	H3		
Facts, maintenance	H4		
Troubleshooting	H5		
I Heating & hot water		M Service Record	
Overview – system layout	I1	Service Record	M1
Boiler	I2		
Control panels	I3		
Normal operation	I4		
Circulation pumps & bleeding	I5		
Maintenance	I6		
Troubleshooting	I7		
J Audio visual			
Overview	J1		
Normal operation	J2		
TV/ FM antenna, directional	J3		
TV/ FM antenna, omni-directional	J4		
Other audio visual equipment	J5		
Satellite dish	J6		
Satellite receiver	J7		
Audio visual schematic	J8		
Maintenance	J9		
Troubleshooting	J10		
K Appliances - other			
Toilet	K1		
Smoke alarm	K2		
Refrigerator	K3		
Cooker	K4		
Tracker	K5		
Air conditioner	K6		
Mover	K7		



Section A – Outfit matching



Trailer dimensions	A1
Trailer weight	A2
Towcar weight & suitability	A3
Towcar and trailer combined weight	A4
Towing equipment	A5

Read this section when choosing your Airstream and matching it with a suitable tow car.

A1 - Trailer dimensions

DIMENSION LIMITS

Restrictions on the size of trailer (length and width) that can be towed by different vehicles vary from country to country.

Check the towing laws in your country before purchasing your Airstream.

In the UK, Dimension limits apply as set out in the Construction and Use Regulations 1986.

The maximum allowable size of trailer towed by a domestic vehicle (gross weight less than 3500kg) is 7m (22ft 11 1/2") long and 2.3m (7ft 6 1/2") wide. The 7m length excludes the drawbar and is therefore the external body length. The 2.3m width includes door handles and anything of permanent character, with a few exceptions, such as lenses of road lights.

WIDTH

European specification Airstreams are available in a choice of 2 widths, loosely described as 2.3m (7ft 6") and 2.5m (8ft).

The actual shell widths for the EU models is shown below, this excludes boiler flues, awning arms, door hinges etc. The widths are designed so the maximum external width including these items falls below the 2.3m and 2.5m maximums allowed in some countries.

2.3m wide models - actual width of shell at widest point = 2216mm (7ft 3 1/4")

2.5m wide models - actual width of shell at widest point = 2413mm (95").

LENGTH

2010 European models are available in 3 lengths - 4.2m (single axle), 5.3m (single axle) and 6.8m (twin axle).

This quoted length is the internal length measured in metres under the front/ rear windows, where the trailer is longest.



4.2m



5.3m



6.8m

DEFINITIONS

Caravan manufacturers in Europe are required to quote the following weights, as defined in European Standard EN 1645-2:1998. These terms are quoted in specifications in the Airstream sales brochure and on VIN/ weight plates fixed to the trailers:

Mass in Running Order (MIRO)

Mass of the Airstream equipped to the manufacturer's standard specification. This excludes items that form part of the Essential Habitation category of Payload – such as the leisure battery, spare wheel etc.

Maximum Technically Permissible Laden Mass (MTPLM)

This mass takes into account the strength of materials, loading capacity of the tyres, axle rating, brake capacity etc. The loaded Airstream must not exceed this limit.

User Payload

This is the difference between the MTPLM and MIRO. Payload is made up of 3 categories: Essential habitation, Personal effects and Optional equipment.

PAYLOAD BREAKDOWN

Essential habitation equipment –

Those items and fluids required for the safe and proper functioning of the equipment for habitation as defined by the manufacturer of the caravan

a) *LPG* – mass of the recommended cylinder(s) when filled to 90% of their permissible maximum capacity

b) *Fluids*

Water heater system – full
Central heating system – full
Freshwater tanks – 90% full
Wastewater tanks – empty
Toilet system flushing tanks – full
Toilet system holding tank – empty
Essential fluids for the use of any other items of standard equipment – full

c) *Electrical supply*

an allowance of 4kg for the low voltage connection cable
the mass of a recommended auxiliary battery, but only where provision has been included

Personal effects –

Those items which a user can choose to carry in a caravan and which are not included as essential habitation equipment or optional equipment

The minimum mass allowance in kg is:

$$M = 10N + 10L + 30, \text{ where}$$

L = the overall length of the caravan in metres, excluding draw gear as given in 6.1.2 of ISO 612:1978

N = the sum of all standard and optional berths

Thus a 6 metre 6 berth EU Airstream will require a minimum personal effects allowance of 150kg (330lbs).

Optional equipment –

Items made available by the manufacturer over and above the standard specification for the caravan

The mass of each item should include any fluids required for their safe and proper functioning

Examples for an EU Airstream might be:

Air conditioning
Fixed 'Zipdee' awning

A2 – Trailer weight

SPECIFICATIONS

Specifications given in Airstream printed sales brochures or on the website state weight information, which is useful for initial guidance and assessment of different floorplans.

These specifications may be based on weights of prototypes. As the MIRO for a production model can be subject to change, we recommend you confirm key items of data with your Airstream dealer, such as the MIRO and MTPLM, for your preferred production model before relying on this information.

VIN AND WEIGHT PLATES

The MTPLM and MIRO of any particular European specification Airstream is best confirmed by inspection of the Airstream itself.

Externally, all European models have a VIN plate fixed to the exterior on the non door side, this displays the MTPLM (as well as other information).

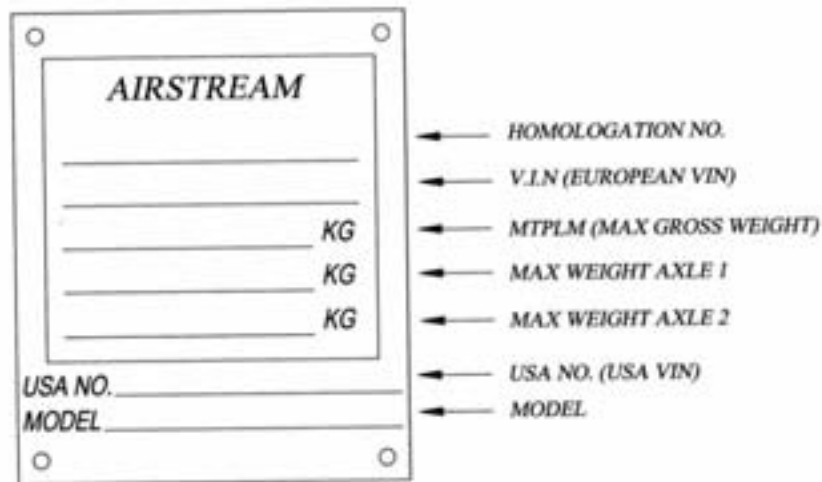

VIN plate

UK models also have a Weight plate fixed to the exterior on the door side, this displays the MIRO as well as the MTPLM, see example below.

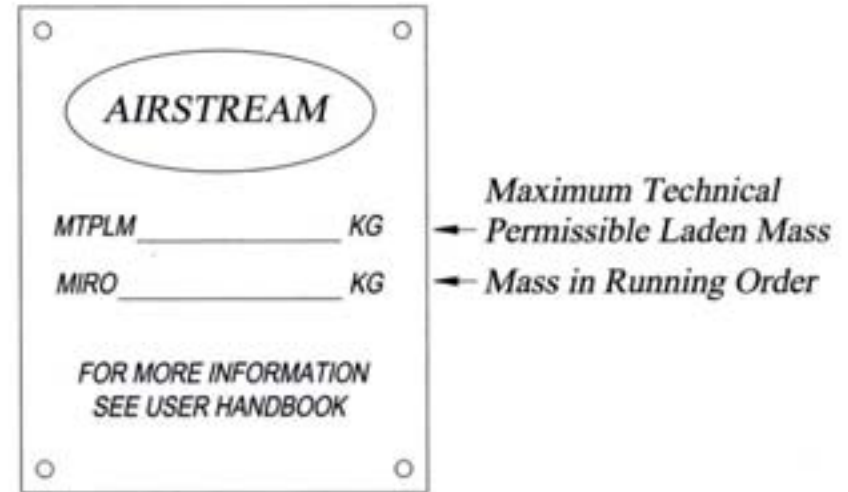

Additional Weight plate (UK models only)

CHASSIS TYPE PLATES

In addition, there are type plates giving weight information for the axle(s) and hitch fixed to the axle(s) and drawbar respectively. These were fitted by BPW at the date of manufacture of the chassis.

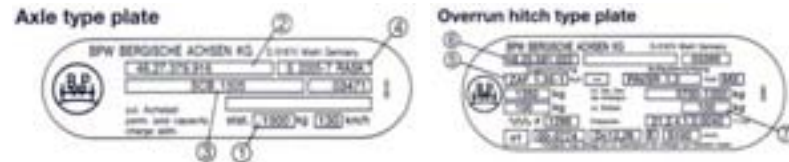

Inspection of these type plates will verify the axle and hitch ratings, highlighted using numbers 1 and 7 in the above examples. These ratings are summarized in the chassis component table in Section E11 of this Manual.

LADEN NOSEWEIGHT

Noseweight is the weight imposed by the trailer coupling on the towball of the tow car.

Noseweight will change depending on which options are fitted to the Airstream and how you load the Airstream with personal effects.

Any items placed to the front or rear will increase or decrease noseweight respectively – the axle(s) in the middle of the Airstream act as a central pivot point.

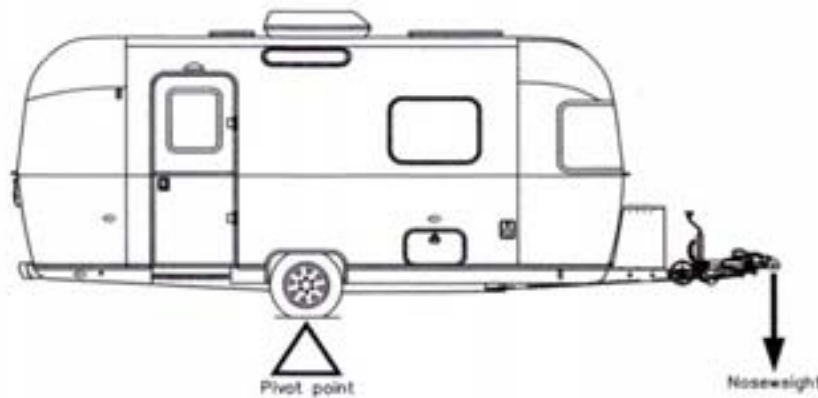

If items of optional equipment are not positioned centrally along the length of the Airstream, this will affect noseweight.

For example, a front chest fitted to the Airstream 532 is positioned at the front and weighs circa 21kg, more than the cushions and slatted seat it replaces. Hence when fitted, the front chest option will increase noseweight, by approximately 10kg.

Other options have minimal effect on noseweight, for example air conditioning, Zipdee awning, or Mover device, because the weight is positioned centrally or evenly forward/ aft of the axle(s).

Similarly, the position of the boiler and fresh water tank can affect noseweight, when full their contents weigh 11.9kg & 45kg respectively. The boiler and fresh water tank positions vary in different Airstreams. If the positions are forward of the axle(s) and you wish to minimise noseweight, to suit a particular towcar, then you may choose to elect to empty the fresh water tank prior to travel.

The type and size of the LPG bottles used and whether they are full or empty will also have a noticeable effect on noseweight, as the LPG compartment is at the very front of the Airstream. For this reason the BP Gaslight composite bottles, being lighter, are popular as they result in lower noseweight.

The sales brochure will give an indication of likely noseweight. This figure is given in a range, for example 90-110kg, to take into account the effect of the fresh water tank being empty or full and variances in the way you load your personal effects.

ACTUAL LADEN WEIGHT AND NOSEWEIGHT

Once you start using your car/ Airstream outfit, the actual laden weight and noseweight of the Airstream should be verified, when the Airstream is loaded as you would normally load it for a trip. See Section C3 for advice on how to weigh the trailer.

The Actual Laden Weight must under no circumstances exceed the Airstream's stated MTPLM.

A3 – Towcar weight & suitability

Whether you choose to buy a new or different vehicle to tow your Airstream trailer, or use an existing vehicle you already have, it is important for your safety and the safety of other road users to assess that your proposed tow vehicle and the Airstream are a suitable match and together will form a stable outfit that is legal on the road in the countries you plan to travel to.

This issue is best considered prior to purchase.

Before reading this section, you need to have considered what the Laden Weight of your Airstream is likely to be when packed ready for the road and secondly, what its predicted Noseweight will be, again in the laden state. See the previous section A2.

Next, the following information should be considered and discussed with your Airstream dealer:

GENERAL GUIDANCE ON TOW CARS FOR EUROPEAN SPEC AIRSTREAMS

The single axle models **422, 532 & 534** (depending on options fitted) can be within the capabilities of saloon cars, large estate cars, MPV's, crew cab pick ups and mid sized 4x4's:



The larger twin axle **684** will require a large to extra large 4x4:



The engine size of the car will affect choice - the larger engine models have higher kerbweights.

The options fitted to the Airstream, plus the way you load the Airstream, will affect its actual laden weight and noseweight and will therefore also have an effect.

To be sure the car and Airstream are well matched, the issues below need to be checked in more detail:

TOWCAR WEIGHT DEFINITIONS

Kerb weight (as defined in UK Legislation – Construction & Use Regulations 1986)

Weight of a vehicle as it leaves the manufacturer with a full tank of fuel, adequate fluids for normal operation (lubricants, oils, water etc.) and its standard set of tools and equipment. It does not include the weight of the driver, occupants or load.

Kerb weight (as defined by EU Directive 95/48/EC)

Weight of a vehicle as it leaves the manufacturer with its fuel tank 90% full, all the necessary fluids for normal operation (see above), a nominal driver weight of 68kg and 7kg of luggage.

Gross Train Weight

The maximum allowable weight of the laden towing vehicle plus the laden trailer in total, the "train" weight. This is defined/ set by the tow vehicle manufacturer and can normally be found in the vehicle handbook. See Section A3 for further advice.

Noseweight

The weight imposed by the caravan coupling on the towball of the tow car. Noseweight limits are stated by the vehicle and towball manufacturer. Most are in the region of 50-100kg, with a few going up to 140/150KG, notably the larger Landrovers, Landcruiser, Touareg etc.

TOW RATINGS

Many customers ask: 'My car has a tow rating of 3000kg, can I not therefore tow any of the EU Airstreams?'

The often quoted "tow rating" is a recommendation set by the tow car manufacturer, which refers to the ability of the vehicle's power, cooling and transmission systems to handle load - typically what it can pull up a 1 in 12 gradient at a standing start.

This is not necessarily what it is suited in reality to tow under a wide variety of conditions, not least speed.

Real life towing conditions impose greater demands on the tow vehicle than this theoretical test. Hence, whilst some EU tow cars have tow ratings up to 3500KG, this does not necessarily mean caravans of this weight can be safely towed, thus tow ratings can be misleading (but should nonetheless not be exceeded).

A caravan is a high sided object. When towed behind a car, it behaves aerodynamically in a different way from say a flat bed trailer carrying cargo. Hence recommendations for caravan towed weights are usually more modest.

KERBWEIGHT RATIO

Check whether the predicted laden weight of the Airstream is a match for the kerbweight of your proposed tow car.

Look in the car handbook or on the car manufacturer's website, or speak to your local car dealer to check the kerbweight of the car.

The Caravan Club in the UK recommends towing a caravan with an actual laden weight not greater than 85% of the kerbweight of the tow vehicle to achieve maximum control and stability. Towing a caravan with a laden weight greater than 100% of the kerbside weight of the towing vehicle is not recommended. To put it simply, the car kerbweight should be at least as much as the trailer laden weight.

So, to correctly match your EU Airstream to a tow vehicle, we advise using the lesser of the tow vehicle manufacturer's recommended "tow rating", or 85% (or up to 100% for experienced caravanners) of the tow vehicle's kerbweight.

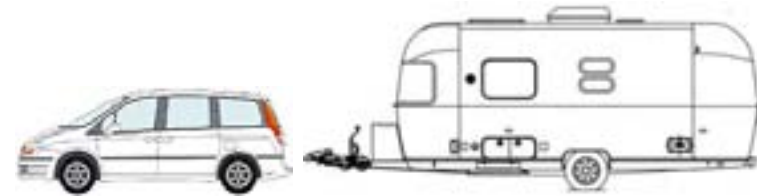

Kerbweight of towcar : Actual laden weight of Airstream

100% : 85%

NOSEWEIGHT CAPACITY

Check that the Predicted Noseweight of the laden Airstream (see Section A2) does not exceed the lower of the noseweight limit of your proposed tow car, or the towbar fitted to it.

INDEPENDENT ADVICE

If you have any doubts on matching your outfit, following discussions with your Airstream dealer, we recommend you seek independent advice.

In the UK, you can:

- register with Towsafe, who operate a Car/Caravan Outfit Matching Service - <http://www.towsafe.co.uk/what.asp>.
- join a caravan club, to access their advice and services, such as the Caravan Club (www.caravanclub.co.uk) who provide advice free of charge to members. One of their many technical leaflets that members can download gives common tow car kerbweights and noseweights.

A4 – Towcar & trailer combined weight

GROSS TRAIN WEIGHT (GTW) – TOWCAR LIMIT

The Gross Train Weight is defined/ set by the tow vehicle manufacturer and can normally be found in the vehicle handbook.

The Gross Train Weight is the maximum allowable weight of the laden towing vehicle plus the laden trailer in total, the “train” weight.

Gross Train Weight = Laden towcar + Laden trailer

It is usually the simple sum of the vehicle’s gross vehicle weight plus its towing limit, but check the vehicle handbook, as it can be less than the simple total.

It is a legal offence to exceed the Gross Train Weight, if stopped by the police and found to be exceeding the gross train weight, you risk prosecution, or your insurance may be invalidated.

Hence, check what the Gross Train Weight is for your proposed towcar when considering its suitability to tow the Airstream. This should be at least the sum of the gross weight of the car (as stated in the car handbook) and the Predicted Laden Weight of the Airstream (see Section A1).

Soon after purchasing the Airstream and periodically thereafter, take your towcar and Airstream when both are loaded for travel to a weighbridge, to check their combined actual laden weights. Keep the weighbridge print out in your car in case you are stopped by the Police as evidence that your outfit does not exceed weight limits.

DRIVER’S LICENCE – TOWING ENTITLEMENTS

The legal position as regards driver’s licences may vary from country to country.

We recommend that you check the law with the driving licence issuing authority in the country you live in.

In the UK: Full information is available on the DVLA’s website, <http://www.dvla.gov.uk/>. The ability to tow a caravan or trailer depends on the driving licence you hold - the category entitlement on your driving licence will determine the type of trailer you can tow.

All drivers who passed a car test before 1 January 1997 retain their existing entitlement to tow trailers until their licence expires. This means they are generally entitled to drive a vehicle and trailer combination up to 8.25 tonnes MAM (maximum authorised mass).

Drivers who **passed their car licence test in the UK after 1st January 1997** (or who have been issued a new licence after this date, EG because of a ban) have lesser entitlements when it comes to towing.

For a category B licence holder with a licence issued after 1st January 1997, the MAM of the trailer must not exceed the unladen weight of the towing vehicle, and the combination must not exceed 3.5 tonnes MAM, unless the driver takes an additional practical driving test, the car and trailer test (B+E).

Do you need the + E Category test to tow your Airstream?

Fill in the boxes A, B & C:

A – kerbweight of towcar _____ kg	You will need a B+E car and trailer licence if your driver’s licence was issued after 1 Jan 1997 and:
B – MAM or gross weight of towcar _____ kg	If C is more than A
C – MAM or gross weight of trailer (the MTPLM) _____ kg	If B + C add up to more than 3500kg

For the purposes of Drivers Licence entitlement, the critical issue therefore is not the actual laden weight of the Airstream, but its maximum authorised mass (the MTPLM).

In other words the driver cannot exceed a 100% ratio of trailer MTPLM to car kerbweight and the sum of the trailer MTPLM and car gross weight must not exceed 3500kg.

The car and trailer test (B+E) is based on the lorry driving test and lasts for approximately one hour. There is no separate theory test, but the practical test includes vehicle safety questions, an off-road reverse manoeuvre, a controlled stop, uncoupling and coupling of the trailer and driving on the road. It does not include any of the following: emergency stop on the public road, reversing round a corner, reverse parking, turning in the road.

TOWBARS

Towbars fitted to EU cars first registered after 1 August 1998 must be type approved under Directive 94/20/EC (except off road vehicles and light commercial vehicles do not yet have to comply with the EC Directive). The hitch ball is 50mm diameter.

Type approved towbars are stamped with an S value – the maximum vertical static load on the towball or eye, measured in kg (noseweight). This tends to mirror the noseweight capacity of the vehicle it is fitted to.

Before having a new towbar fitted, contact an industry association, such as the National Trailer and Towing Association (NTTA) in the UK, www.ntta.co.uk for advice on selection and fitting.

You should ask what the S value will be (maximum load in kg) and what the coupling height will be when fitted to your car.

COUPLING HEIGHT

The coupling height or hitch height, is equal to the height from the ground to the centre of the towball, or from the ground to the centre of the trailer coupling when the trailer is level and loaded to the MTPLM. The coupling height will vary for different Airstreams and from car to car. This should ideally be considered at the 'outfit matching' stage, because for stability the trailer should be towed level, or slightly 'nose down'.

The ideal is for the towball height on the car to be slightly less than, but not more than, the coupling height on the trailer.

Measure the height of the towball on the towbar on your car, if already fitted, or consult your car dealer to ascertain what the coupling height will be when the towball is fitted. Some towbars have adjustable heights, for example those fitted to some Landrovers. Then compare the actual/ likely towball height on your car to the coupling height on the trailer.



The requirements affecting coupling heights for EU tow vehicles and trailers are:

- Tow vehicle - EC Directive 94/20 requires vehicles registered since 1/8/98 (except off road vehicles which are exempt) to have a type approved tow bar with centre of ball between 350-420mm above ground when the vehicle is conventionally 'loaded'.
- Trailer – the same EC Directive 94/20 requires the coupling point of the trailer coupling to be 430mm +/- 35mm from ground – with the trailer laden to permitted axle load and the trailer horizontal. In the UK, BS 6765 requires trailers in the UK to be at 415mm +/-30mm, but this is likely to be revised to come into line with the EC Directive.

In Europe, the same trailer could therefore be connected up to a vehicle with a tow ball height between 350-465mm, or even higher if that vehicle is classed as an 'off road' vehicle. Estate cars have a typical towball height of 385/390mm, whereas a 4x4 towball is typically in the range 420/450mm.

This variance in coupling height is less critical (in terms of stability) for single axle models, which are best towed slightly 'nose down'.

A twin axle caravan with standard axles working independently of each other needs to be towed level, not nose down (or worse still nose up), or one axle & set of wheels/ tyres may be taking more than its designated maximum loading. The tyre contact with the road also changes, affecting stability.

For this reason, Airstream has specified load compensation axles for its twin axle model(s), these allow equal distribution of weight between both axles, ensuring optimum stability.

TYRES

The rear tyres of the car must be inflated to the car manufacturer's recommended pressures for towing, please refer to your car handbook or car dealer and adjust the rear tyre pressures accordingly.

When driving in winter, in countries where there is a high risk of snow or ice conditions during winter months, it is recommended – particularly when towing – that winter tyres are fitted to all 4 wheels of the towcar to give better grip. This is a legal requirement in some countries – check before travelling.

A winter tyre is made of special silica rubber compounds, which are better adapted to the cold and enable better braking. The tyre has a deeper tread and is designed to displace the water passing under the tyre and give better grip on snow.

A5 – Towing equipment

TOWING ELECTRICS

Towing electrics allow the trailer's road lights and other internal auxiliary equipment to be powered by the tow car's 12v system. To ensure the required connections are made in a correct and safe manner, the towing electrics are best installed by a specialist, typically the same company that fits the towbar.

Choose a company belonging to a recognised Association that gives some assurance of quality, such as the NTTA in the UK (www.ntta.co.uk). Question the company you intend to use on their knowledge of your particular car, as wiring varies from car to car. Ensure the fitter's work will be fully guaranteed and approved by the car manufacturer.

In the UK, the most common wiring standard for cars and trailer consists of two 7 pin sockets, commonly referred to as 12N and 12S. The 12N socket, usually coloured black on the tow car with black insulated cable contains all of the legally required trailer road light circuits. The 12S socket (usually coloured grey or white, with grey or white coloured cable) provides additional circuits for powering the reversing lights (not currently a legal requirement on trailers in the UK) and other auxiliary power connections for 12v fridge operation, battery charging etc.



In continental Europe, a single 13 pin socket is more standard and there are 2 commonly found types:

- The first is commonly referred to as 'Volta/ Jaeger' needle type, see [left two images below](#). It is easier to get adaptor leads to convert this socket to 12N and 12S, the disadvantage is this 'needle' type connector will not mate with a standard 12N socket. Also, adaptor leads can make the cables too long and at risk of dragging on the ground while traveling.
- The second is commonly referred to as 'WeSt' (short for Welt-Stecksystem), see [right two images below](#).



The advantage of the WeSt socket for UK users, is the WeSt male plug will mate with (and therefore can be plugged into if necessary) a 12N socket to power the road lights.

However, the pins of the WeSt socket are thinner cross section and more easily bent/ broken.

Hence for 2010 we are recommending to new customers that the Jaeger male 13pin plug be fitted to the Airstream and the corresponding Jaeger female 13 pin socket be fitted on their towcar. Then all circuits will be connected when towing, to enable battery charging, fridge operation on 12volt, reversing lights to function etc.

Pin layouts for the Jaeger and WeSt 13 pin sockets are shown below:

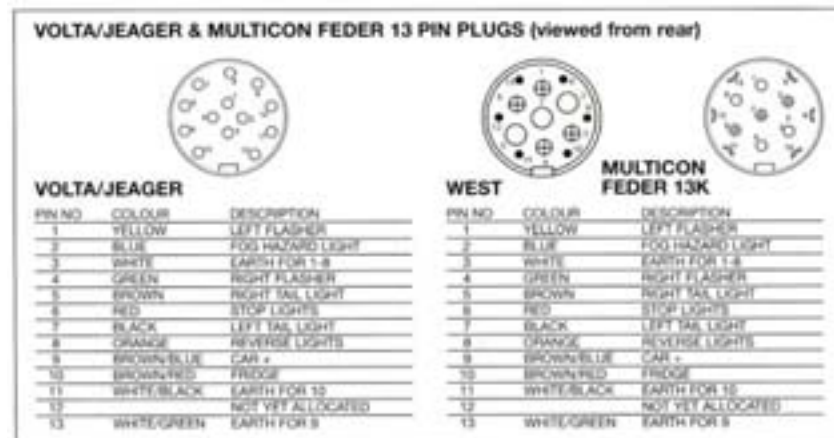

TOWING MIRRORS

The addition of a trailer behind a car, like an Airstream, reduces rear visibility from the car. The internal car mirror may still provide some views through the Airstream, depending on the floorplan and whether internal doors/ curtains in the Airstream are left open (recommended for night towing, when headlights of vehicles behind will shine through).

Most towcars will not be as wide as the Airstream, thus visibility using the external mirrors of the car will also be reduced, more so with the wider 2.5m wide EU models.

For these reasons, we recommend additional mirrors are fitted to the nearside and offside when towing (these should be removed when driving solo), to provide an adequate view to the rear when towing.



Models that clip onto the existing car mirror are generally quick and easy to fit, methods of attachment vary. A choice of types should be available from your local caravan accessory shop.

SUSPENSION AIDS

Adding the noseweight of a trailer with a relatively high noseweight to the rear of your towcar can cause problems with the rear suspension, if the additional weight on the rear of the car results in the car no longer riding level.

Some cars offer self levelling suspension to cope with this, for example some Landrovers* have air suspension, which adjusts to load placed in the rear boot and on the towbar, to keep the car level.

** (all Range Rover, most Series 2 Discovery, 7 seater Series 3 Discovery – but not the 5 seat Series 3 Discovery and not any Freelanders; but always check with your local dealer)*

Those without suspension aids may suffer problems of reduced ground clearance, headlights tilted up too high and impaired handling. Front wheel drive cars may find traction, as well as steering affected.

After market suspension aids fall into 2 categories, those which are replacement shock absorbers and those which affect the car's suspension. This is a specialist area and expert advice should always be sought.

Before considering rear suspension aids, first check with your car dealer that the car's normal suspension and shock absorbers are working at near 100% efficiency.

STABILISERS

Stabilisers are designed to reduce/ dampen snaking and pitching between the towcar and trailer.

The Airstream Europe chassis made by BPW is fitted as standard with a Winterhoff WS3000 overrun coupling, with integrated stabiliser, approved for noseweight up to 150kg and max trailer load of 3000kg. A wear indicator shows when the friction pads require replacement. See Section E3 for detailed advice on operation.



Independent tests on caravan stability by the University of Bath in the UK show this type of tow ball frictional stabiliser does have a significant effect on the damping of the car/caravan yaw oscillation following a steer input, the conclusion being that the stabilised outfit has more satisfactory behaviour at any given speed.

Some consider stabilisers dangerous as they disguise early warning signs that would otherwise alert the driver to taking the right action (slowing down!).

Most importantly therefore, the use of aids such as stabilisers that help reduce snaking should not be seen as a substitute for a well matched tow vehicle/ trailer combination that is correctly set up (hitch height, tyre inflation etc.), properly loaded and driven at sensible speeds.

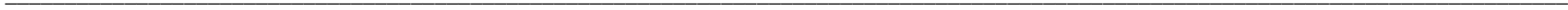

Section B – Before/ at handover



Towing safety advice

B1

Fire

B2

Ventilation

B3

Children

B4

Insurance

B5

Security

B6

Warranty

B7

Review this section with all drivers and family members before you collect the Airstream, especially if you are new to towing.

B1 – Towing safety advice

TOWING V'S DRIVING SOLO

Towing a trailer is different from driving solo. Most accidents are due to mis-use – either driving at excess speeds, bad loading of the caravan, sudden direction change etc.

The following four key issues will determine whether your outfit is safe and comfortable to tow, you need:

- 1) A properly matched outfit, hitched at the correct height – see Section A
- 2) Properly distributed equipment in the Airstream and towcar – see Section C
- 3) Timely effective maintenance – see Section E
- 4) To drive the outfit correctly.

The next sections below give some advice in relation to point 4) above, how to drive the outfit correctly.

For further background reading, we recommend 'Towing Roadcraft - The Essential Towing Handbook, by the Police Foundation', written by Phil Coyne and published by the Stationery Office (£9.99) in the UK. ISBN 0-11-552022-8

SPEED

Know and observe speed limits, these vary from country to country, but tend to be lower for cars towing trailers.

- In the UK, speed limits when towing are 50mph and 60mph on single and dual carriageways respectively.
- In continental Europe, permitted speeds for towed outfits vary, for example 80km per hour (many countries including Germany and Holland). In France the limit is 130kph, but this reduces to 110km per hour in France if the gross train weight of the outfit is over 3500kg (which will be the case with most Airstream outfits).

Aside from risking fines, speeding when towing increases the risk of accidents. Remember that the maximum permissible speed is not the same thing as a safe speed. The safe speed for a particular stretch of road is determined by the actual conditions.

Your outfit is longer, slower, takes longer to accelerate and brake and handles very differently from a solo vehicle. Generally, a safe speed is a slower one when towing!

! WARNING The faster you go, the greater the risk of losing control of your outfit, the less chance of taking avoiding action and the greater your risk of having an accident.



STOPPING DISTANCES

Driving too close to the vehicle in front is one of the commonest causes of accidents. There is a greater risk for drivers towing a trailer because of the reduced braking efficiency of outfits. The additional load of a trailer means the tow car will take longer to stop at speeds, hence it is all the more important to observe safe stopping distances.

If the driver behind you is too close, increase the distance between yourself and the vehicle in front. It will allow you to brake more gently, giving the vehicle behind more time to stop.

USE OF MOTORWAY LANES

Laws vary from country to country, know the laws for the countries you will be travelling in.

In the UK, do not tow the Airstream in the outside lane of a three or four lane motorway.

SWAY AND SNAKING

There is a natural tendency for a trailer to sway slightly due to its own momentum & external forces. Snaking is the worsening development of sway.

The rounded nature of the Airstream travel trailer helps reduce the extent to which the slipstream of large overtaking vehicles will affect your outfit, but there are a number of preventative guidelines you should follow to maximise your safety and reduce the risk of sway developing:

- 1) First, follow guidelines for outfit matching (Section A) and loading (Section C), keep within the towcar and Airstream's permitted weight limits. A fundamental cause is an ill matched outfit.
- 2) Ensure the towcar and Airstream's tyres are kept inflated at the correct pressures.
- 3) Listen to weather forecasts and avoid if possible travelling when towing in high wind conditions.
- 4) Drive at a speed appropriate for the outfit and conditions – reduce speed doing down hills and in windy conditions.
- 5) Watch your mirrors for fast moving large vehicles coming up behind and preparing to overtake.
- 6) Maximise the gap between your outfit and an overtaking vehicle by keeping well to the inside (left side in the UK) of your carriageway. The most effective time to take action is just before the overtaking vehicle comes level with your outfit. If you can move over as far as safely possible at this point, then the disturbance on your outfit will be less.
- 7) If you see the Airstream rear end sway in your rear view mirror, take your foot off the accelerator and slow down on the overrun of the engine.
- 8) Realise if you have seen a rear end sway, that your outfit is not as stable as it could be and you risk encouraging a snake. The sway will get worse at higher speeds or under more severe buffeting.
- 9) Rectify the outfit loading at the first safe available opportunity to stop and in the meantime SLOW DOWN. When you can stop, reconsider the outfit matching - examine and rearrange your loads, check your tyre pressures and noseweight.
- 10) If you have applied all the above and a sway develops into a snake, then:
 - Steer in as straight a line as possible without forcing your will on the steering wheel by sudden or sharp corrections; these worsen the pendulum effect
 - Let the steering wheel twitch in your hands – it will – until the snake ends.
 - Take your foot off the accelerator and let the engine slow the outfit until the snake disappears.

In a snake occurring travelling downhill only, do – but VERY VERY GENTLY – apply the brakes; sharp braking worsens the pendulum effect.

! WARNING DO NOT attempt to power out of a snake by accelerating, DO NOT see-saw the steering wheel, DO NOT slam on the brakes.

REST STOPS

A rest stop every two hours is recommended, both for drivers and passengers and for your towcar, which has been working harder than when driving solo.

You should take the opportunity whenever you stop to look around the outfit and check that everything looks normal.

Do not unhitch the Airstream at a rest stop. This will prevent the Airstream tipping back if one person enters inside and walks to the rear (for example to use the bathroom on rear bathroom models). One or two rear corner steadies should be lowered if the stop is to be more prolonged, for example a lunch stop, during which all the family may enter the Airstream.

Whenever possible, choose locations for rest stops that are set back from the road. If stops have to be made by the side of the road, either in a lay-by or on the side of the road in emergencies, please observe the following:

! WARNING The Airstream has the entry door on the right side. When being used in left hand drive countries (such as the UK), care must be taken if entering or exiting the Airstream by the side of the road. Children in particular may not appreciate the dangers of exiting onto the road side, where cars may be passing. Always supervise any persons entering or exiting the Airstream if the entry door is on the road side. It is particularly hard to see oncoming traffic if the door is hinged on the rear side.

TIP: Keep a small hand held mirror in the Airstream to use to check for approaching cars if you have to stop and enter/ exit from the Airstream with the entry door on the road side.

FOULING

Care must be taken to prevent fouling when traversing ramps or other ground obstacles. Try to avoid very steep driveways and always leave plenty of room between the Airstream and pavement kerb when parking.

! CAUTION The manual entrance step fitted on single axle models (532 and 534) projects below the chassis and is vulnerable to impacts, for example from high sided kerbs or it can ground on steep ramps.

B1 – Towing safety advice

REVERSING PRACTICE

Straight line reversing and reversing around corners should be practiced in a large empty car park, on a number of occasions, until you feel confident of technique and able to repeat this in real situations, like reversing into campground pitches or onto ferries. Practice will make perfect!

Start by drawing forward until car and Airstream are in a straight line. Then start to reverse very slowly. All movements in reverse are best done slowly, so the trailer does not turn quickly, for if it does, it is more difficult to correct.

Different instructors give different tips for knowing which way to turn the steering wheel. Our recommendation is to hold the steering wheel with one hand at the bottom, look in the rear view mirror and turn the wheel a little in the direction you want the rear of the Airstream to go.

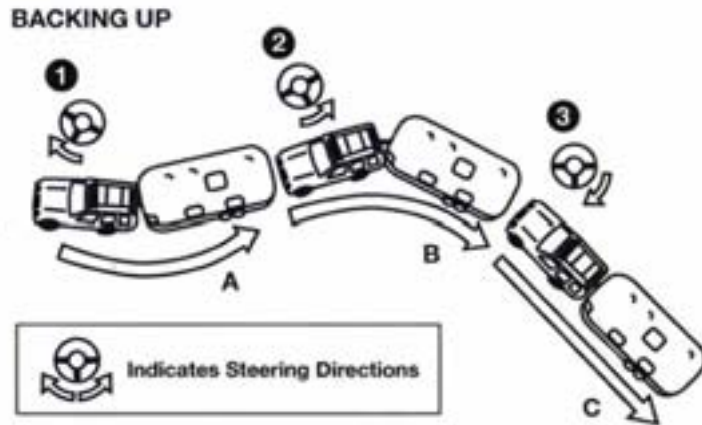

As the rear of the Airstream starts to move that way, the image of the Airstream will begin to fill the mirror. If the Airstream turns too much, turn the steering wheel the other way to correct. Don't hesitate to pull forwards to straighten up the outfit and try again.

Small corrections at the steering wheel as you move slowly backwards is the best strategy. The straight line reverse is simply a series of small corrections at the steering wheel.

! CAUTION The reversing light on the rear of the Airstream will not operate unless the 13pin towing electrics connector on the Airstream is plugged into a matching connector on the towcar, or an adapter is used so the reversing lamp circuit is connected.

REAL REVERSING SITUATIONS

Follow the advice below to help you successfully reverse in real situations:

- First scan the area. This is best done by foot (i.e. get out of the car to inspect the area you need to reverse into, ensuring the car handbrake is applied first). Check for obstructions – both at low level (such as posts or bollards, bushes, high kerbs) and at high level (street signs or trees which may overhang into the road etc.).

If you are reversing on your own without any other aids, you may need to get out of the car several times during the manoeuvre to check your position. Don't hesitate to do this if you are unsure how much room there is behind the Airstream. Don't allow others to make you feel rushed and take risks.

- If you have a companion, ask them to stand where they can clearly see both the rear of the Airstream and any obstructions as you reverse, to direct your reversing and give you proximity warnings. However do not allow your companion to stand in a position where there is a risk of injury to them.
- Consider fitting a reversing aid, such as a reversing camera to the rear of the Airstream.
- If you are reversing at night, a large torch which can be placed on the ground marking the point where the rear of the Airstream should finish and illuminating any obstructions along the side of the Airstream, is a useful aid. Turn the porch light and offside service light on the Airstream on, which will also help illuminate obstructions down either side.
- If a Mover device is fitted, uncouple the towcar, stand where you can see both the rear of the Airstream and any obstructions and operate the remote controls of the mover device to reverse the Airstream into position.

! CAUTION Whilst the Airstream has a rear bumper, this protects the low level areas only. The bumper does NOT project past the outer most extremity of the rear of the Airstream (the grab rail and LED light clusters), hence the rear remains vulnerable to damage if reversing against taller objects, such as a vertical wall. Always take care when reversing and manoeuvring the trailer.

DRIVING IN MUD OR ON WET GRASS

Mud and even wet grass on a slight slope can be on problem on a site, even for solo vehicles.

If the weather is doubtful, ask if a hard pitch (tarmac or gravel) is available.

If only a soft pitch is available, park with the front of the Airstream as close as possible to a hard surface. Also try and park so when you leave, you are driving down any slope.

When moving off, keep engine revs low and steer as straight as possible.

STOPPING ON A HILL

When stopping on a hill or slope, leaving your tow vehicle in gear is not enough for standstill safety.

Do not rely on the towcar or Airstream parking brakes. **CHOCK THE TRAILER WHEELS** to be double sure.



TRACKING

When turning corners, remember that the trailer wheels will not follow the path of the towcar wheels – you need to make wider turns when towing to ensure that the trailer wheels clear any corner obstructions, but not so wide as to swing out into oncoming traffic.



OTHER TOWING SAFETY ISSUES

Do not tow the Airstream whilst it is occupied.

Do not carry LPG bottles loose in your towcar or the Airstream, portable cylinders must be secured in a vertical position in the locker provided on the front of the Airstream.

Turn off gas appliances before travelling, except those heating appliances designed to function while the vehicle is in motion (the Alde 3010 boiler used in 2007 EU spec Airstreams is designed to be usable on gas operation whilst the vehicle is in motion).

Robstop hitchlock

Robstop WS 3000 hitchlocks are available to fit the WS 3000 stabiliser coupling. These can be purchased from BPW, or your Airstream dealer.

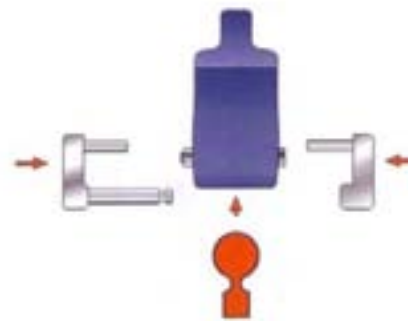

To fit the Robstop hitchlock, first place the plastic ball sharply into the underside of the coupling head. This will allow the stabiliser handle to be lowered to the horizontal (closed) position.



Then place the 2 cast metal parts of the hitchlock either side of the coupling head and turn the key to lock.

B2 – Fire

FIRE PREVENTION

! WARNING

- **Do not smoke in bed**
- **Never use portable cooking or heating appliances inside the Airstream, other than electrical heaters that are of the radiant type, as it is a fire and asphyxiation hazard.**
- **Never use the fitted cooking equipment as space heating.**
- **Keep matches out of reach of small children!**
- **Don't clean with flammable materials!**
- **Keep flammable material away from open flame!**

We have all heard these warnings many times, but they are still among the leading causes of fires.

FIRE DETECTION - SMOKE ALARM

The smoke alarm fitted has an alarm silence/ hush feature and is approved for use in vehicles such as travel trailers.

DO NOT disconnect the battery, the smoke alarm is provided for your safety. To stop a false alarm, press the button on the unit (same as the test button). The alarm will go into Hush mode for 10 minutes, then automatically reset. While in Hush mode, the alarm will still detect, but sensitivity is decreased. Always determine why the alarm has been triggered before pressing the button.

The 9v battery lasts approximately one year. About a month before the battery is completely flat, the alarm emits a short signal once a minute. This is the signal that the battery needs changing. Test the alarm after changing the battery.

! WARNING Ensure a new battery is correctly installed with +ve terminal to +ve contact (marked +), negative terminal to negative contact.

Under the test button, there is a red control lamp which flashes once a minute. This shows the battery is correctly connected.

! WARNING Test the alarm weekly, or after prolonged storage periods, by pressing the test button for at least 10 seconds until the alarm sounds.

FIRE ESCAPE

In the case of fire:

1. Get everyone out of the Airstream as quickly as possible using whichever exit is the quickest. Do not stop to collect any personal items.
2. Raise the alarm. Call the Fire Brigade.
3. Turn off the gas supply using the valves on the cylinders, if it is safe to do so.
4. Turn off the electricity supply at the supply point.

Purchase and keep a dry powder fire extinguisher complying with ISO 7165 of at least 1kg capacity by the exit door and a fire blanket next to the cooker.

! WARNING Read the directions carefully on the fire extinguisher. If there is any doubt on the operation, you and your family should practice, then replace or recharge the extinguisher.

Familiarise yourself with the local fire precaution arrangements, if staying on a campsite.

ESCAPE WINDOW OPERATION

Make sure you and everyone travelling with you can operate the main door and emergency exit window(s) rapidly without light. Contemplate other means of escape in case the designated exits are blocked. Run emergency drills.

The escape window(s) are identified by red release handles and are opened by lifting up both handles, then turning the latches towards the centre. A loop is provided in the SCREEN RETAINING SPLINE so it can be rapidly removed. Take hold of the loop and pull the rubber spline out of the screen frame. Then push out on the window glazing and the window will swing clear.

! WARNING Learn and practice the entrance door and escape window operations, so you and your family can escape even in total darkness.

! WARNING Check the emergency escape route outside your escape window at every stop, make sure you have not parked in such a manner as to block the operation of the escape window by being too close to trees, fences, steep drops etc. Never park your trailer so the escape windows cannot be easily used for emergency exits.

VENTILATION

European Airstreams comply with the safety ventilation requirements of the European Standard BS EN 721. The fixed ventilation points are provided for your own safety. They should not be obstructed and should be checked and cleaned periodically as necessary.

There are 2 No. rectangular vents through the floor at the very front, with insulated ducts fitted up to the underside of the doubled front convectors. This ensures that cool air entering at floor level, which is necessary for safe ventilation, is pre-heated before entering the Airstream.

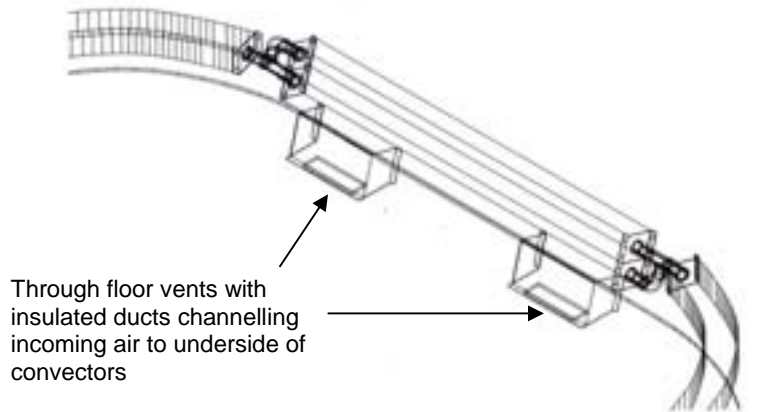

Through floor vents with insulated ducts channelling incoming air to underside of convectors

On larger twin axle models there are similar rectangular through floor vents to the rear under the fixed beds, also with insulated ducts.

These larger rectangular ducts are protected from road spray by protective cowls fitted to the underside of the floor. These should be inspected periodically from below to ensure they remain unobstructed, clean and free from debris and dust.

Additional low level ventilation is provided by gas drop holes under the front corner convectors, the fridge and cooker.

High level ventilation is provided by ventilation grilles in the Midi Heki rooflights.

Under no circumstances should any of these safety vents be blocked or obstructed.

When cooking, open windows to provide additional ventilation and use the extract fan provided over the cooking hob.

CHILDREN

Do not leave children alone in the Airstream.

Keep potentially dangerous items like matches, drugs etc. out of reach, as at home.

Care must be taken against the risk of falling out when beds (especially any upper bunks) are used by children, particularly under 6 years of age. Upper bunks if provided are not suitable for use by infants without supervision.

! WARNING The Airstream has the entry door on the right side. When being used in left hand drive countries (such as the UK), extreme care must be taken if entering or exiting the Airstream by the side of the road. **Children in particular may not appreciate the dangers of exiting onto the road side, where cars may be passing.** Always supervise any persons entering or exiting the Airstream if the entry door is on the road side. It is particularly hard to see oncoming traffic if the door is hinged on the rear side.

B5 – Insurance

INSURANCE

Ensure you take out adequate insurance for the car and caravan from the moment you collect or will take delivery of the Airstream.

Insurers vary from country to country. Speak to your Airstream dealer for local information.

Airstream insurance – Ask your Airstream dealer for contact details for insurance companies who can offer quotes and terms for insuring the Airstream.

When contacting insurers, you need to state the model of Airstream and retail value including optional equipment.

Tracker installation - The fitting of a tracker device is required by some insurers.

All EU Airstream models are pre-wired with a GPS antenna, to allow a tracker device to be fitted. If you choose to have the tracker fitted, this can be done prior to the handover and the cost of installation and the first year's subscription added to the purchase price.

Car insurance – Please confirm with your car insurers that your car insurance policy has no unusual exclusions regarding towing a caravan.

Breakdown cover – Compare cover available from different breakdown assist companies for towed outfits, including recovery of the Airstream (some companies place limits on length of caravan).

Caravan theft is common, please take precautions to deter theft of your Airstream.

Always secure all windows and doors when leaving the Airstream unattended.

SECURE STORAGE

If the Airstream is hidden and not readily visible to passers by, the risk of theft reduces.

If you choose to store the Airstream at home, consider screening measures to hide it from view and devices such as removeable posts to improve security of your driveway.

Alternatively, store the Airstream at a secure storage facility. In the UK, contact CaSSOA (www.cassoa.co.uk) for a list of independently assessed storage facilities.

CHASSIS AND CRIS WINDOW VIN MARKS

All European models are allocated a unique 17 character VIN (vehicle identification number) which complies with the numbering sequence used by CRiS (The Caravan Registration Insurance Scheme) in the UK.

All EU models have this 'European VIN' stamped (2nd line down) on the VIN plate fixed to the exterior of the Airstream.

This European VIN is also stamped on the chassis (to the front of the right side chassis rail) to provide visible identification.

Airstreams sold in the UK are registered on the CRiS database. The CRiS scheme provides both registration (the VIN is entered on a national register of UK manufactured touring caravans) and identification – the 17 character VIN is etched on the windows to deter theft and an electronic tag is fitted (see below).

Soon after UK customers purchase an Airstream, they will receive a CRiS registration document sent to their home address. This confirms the registered keeper, the VIN and the full vehicle description. This should be kept in a safe place at home.

ELECTRONIC TAGGING

Airstreams sold in the UK have a concealed electronic tag, this contains the individual identity (VIN) and can be read by a special decoder, which local police can obtain from CRiS (+44 1722 411430).

WHEEL AND HITCH LOCKS

Mechanical devices such as wheel locks and hitch locks do help deter theft, by all but the most determined thieves.

The BPW Robstop hitchlock is designed to fit the coupling fitted to the Airstream and can be purchased from your Airstream dealer.

A variety of wheel locks are available, such as the 'Authority Model B' from Hansons, see: www.wheel-clamp.com.



TRACKER

All EU Airstream models are pre-wired to allow a tracker to be fitted, triggered by a tracker device to be fitted.

The fitting of a tracker is recommended, as the best means to recover the Airstream should it be stolen. A tracker device utilises globally positioned satellites - a number of which are always 'overhead'.

The location of the Airstream is transmitted using current mobile phone technology back to a call centre. The position is then used in conjunction with mapping software to produce a street level map pinpointing the location to within thirty feet, subject to a mobile phone signal being available.

In the UK, try Phantom (see: <http://www.caravan-alarms.co.uk/>)

The tracker device is triggered by a motion sensor switch, the on/ off switch for the motion sensor (if fitted) is the small black rocker switch usually located to the end of the joinery unit nearest the trailer entrance door. To turn the tracker off, the switch should be in the 0 = OFF position (position 1 = ON).

B7 – Warranty

WARRANTY

Warranty Coverage

When you buy a new Airstream Travel Trailer from an authorized Airstream dealer, Airstream, Inc., warrants the trailer from defects in material and workmanship as follows:

Basic Warranty Period

This warranty extends for a period of 2 years from the date of original retail purchase.

Items covered

Any part of the trailer or any component equipment installed by the factory in the USA, or at the point of final fit in the United Kingdom by Airstream Inc's distributor Airstream Europe Limited, is covered by the basic warranty except the following items, which are not covered:

Tyres & batteries – these are not covered by the basic warranty.

This limited warranty does not include failure caused by accident, abuse, normal wear, overload or any cause not attributable to a defect in original material or workmanship of the trailer or component equipment as installed by the factory or distributor as described above.

Limitation of implied warranties

All warranties of merchantability and fitness for a particular purpose, whether written or oral, expressed or implied, shall extend only for a period of two years from the date of original purchase. There are no other warranties, which extend beyond those described on the face hereof and which expressly excludes conditions resulting from normal wear, accident, abuse, exposure or overload.

Airstream's responsibility

The basic Airstream Limited Warranty applies for a period of two years from the date of original purchase and the application date of all warranties is that indicated on the owner's Limited Warranty.

Defects in items covered under this Warranty will be corrected without cost upon the return, at the owner's expense, of the trailer or defective part to Airstream Europe Limited's UK premises, or an authorised Airstream dealer in Europe.

Owner care and maintenance

This warranty covers only defective material and/ or workmanship; adjustments are made at the factory in the USA prior to shipment, during final fit in the UK, and rechecked by the dealer prior to delivery to the customer. Adjustments made thereafter become a customer responsibility.

Each Airstream exterior (not including the underside) is clear coated to prevent oxidation. This application is covered by a two year warranty against peeling. Prolonged exposure to salt air or corrosive air borne pollutants will permit penetration through the coating material, causing damage to the exterior finish. Since Airstream Inc. has no control over these conditions, it is necessary for the owner to wash and maintain their trailer as instructed in this Owner's Manual.

The owner is responsible for following all maintenance recommendations, instructions and precautions contained in this Owner's Manual and the individual operation and use manuals furnished by the chassis, appliance and other manufacturers.

Installations not covered

Airstream Inc. and Airstream Europe Limited do not accept any responsibility in connection with any of its trailers for additional equipment or accessories installed at any dealership or other place of business, or by any other party. Such installation of equipment or accessories by any other party will not be covered by the terms of this warranty. Recourse should be made to the dealer concerned.

If repairs are needed

If your trailer needs repairs under the terms of the basic Airstream Limited Warranty, you should:

1. Take your trailer to your selling dealer, or other authorized Airstream dealer.

No work shall be commenced under the terms of the warranty unless prior authorisation is obtained from Airstream Inc., via its distributor Airstream Europe Ltd.

Airstream Inc and/ or Airstream Europe Ltd reserve the right to inspect the trailer before any works commence. Airstream Inc. reserve the right not to approve a warranty claim if the original construction of the Airstream has been tampered with or repaired other than by Airstream Europe Ltd, or an Airstream dealer or service workshop approved by Airstream Europe Ltd.

2. If the dealer is incapable of making the repairs, request that he/ she contact the After Sales Department at Airstream Europe Limited, for technical assistance.
3. If repairs are still not made, the customer should contact:

Airstream Europe Limited

Unit 8, Clock Garage Industrial Estate
Tebay
Cumbria
CA10 3TL

The following information should be provided:

- The EU VIN and US VIN for the trailer
 - Date of original purchase
 - Selling dealer
 - Nature of service problem and steps or service performed
4. If after taking the above steps repairs are still not complete, the Airstream owner may request the trailer be brought to Airstream Europe Limited at the owner's expense.

Dealer representation excluded

Airstream Inc. and Airstream Europe Limited will not be responsible for additional representations or implied warranties made by any of its dealers or suppliers to the extent those representations are not a part of, or are contrary to, the terms and conditions of the basic Airstream Limited Warranty.

Consequential and Incidental damages

Airstream Inc. and Airstream Europe Limited will not be responsible for any consequential or incidental expenses or damages resulting from a defect. Incidental expenses include, but are not limited to: travel expenses, fuel, oil, road tolls, lodging, meals, telephone bills, loss of work, goodwill and loss of use of the trailer. Some examples of consequential damages would be: loss incurred by accident or fire, stained curtains due to rain leaks or delaminated floor caused by a plumbing leak.

Warranty transfer

The basic Airstream Limited Warranty is transferable to subsequent owners for the duration of the warranty period. New owners should contact Airstream Europe Limited with proof of ownership, service history and their payment of £25 to have their details recorded.

Changes in design

Airstream Inc. reserves the right to make changes in design and improvements upon its product without imposing any obligation upon itself to install the same upon its products already manufactured.

Explanation of Airstream Limited Warranty

The Airstream Limited Warranty is a separate document, which will be filled out by the dealer and presented to the owner during delivery of a new unit.

The Limited Warranty must be presented to a dealer to obtain warranty service. It should be kept in the trailer during the warranty period.

Exclusions

Normal Wear – Items such as tyres, curtains, upholstery, floor coverings, window door and vent seals will show wear or may even wear out within the two year warranty period depending on the amount of usage, weather and atmospheric conditions.

Accident – We strongly urge our dealers and customers to inspect the trailer upon receipt of delivery for any damage caused by accident that may have occurred while being delivered to the dealer, or while it is at the dealer's premises. Damage of this nature becomes the dealer or customer's responsibility upon acceptance of delivery, unless Airstream Europe Limited is notified and the person making the delivery verifies the damage. Glass breakage, whether obviously struck or mysterious, is always accidental and covered by most insurance policies.

Abuse – Lack of customer care and/ or improper maintenance will result in early failure for which neither Airstream, or its distributor Airstream Europe Ltd can be held responsible. No liability will be accepted for damage caused by willful damage, negligence, intrusion of foreign or harmful matter, over-heating, freezing, failure to follow user instructions set out in this manual or alteration or repair of the Airstream without prior approval from Airstream's distributor.

B7 – Warranty

Inappropriate Use - Airstreams covered by this warranty shall not be put out to hire, reward, or any other commercial use, nor be used for any event, race or purpose or subjected to any condition which could reasonably be foreseen to cause or result in damage or excessive wear and tear.

Exposure – Aluminium oxidises if subjected to prolonged exposure to moisture, salt air, or corrosive air-borne pollutants without protection, such as the clear coat lacquer on an Airstream. Extremely hot or direct sunlight will deteriorate rubber and fade curtains and upholstery. Conditions of this nature, although they may be normal for the area, are beyond Airstream's control, hence any damage caused by exposure becomes the responsibility of the owner.

It is the responsibility of the owner to take such preventative measures as are necessary to maintain the exterior caulking and sealer of their trailer, to wash and maintain their trailer as instructed in the Owner's Manual and to store it appropriately to provide shelter from adverse exposure.

It is the responsibility of the owner to use reasonable, prudent care to prevent foreseeable secondary damage from rain, plumbing leaks and the natural accumulation of moisture internally, which can cause delaminated floors, stained upholstery, carpeting, mould formation etc. Mould is a natural growth given certain environmental conditions and is not covered by the terms of the Limited Warranty. Use of the heating system on low setting during winter months as per the heating system manufacturer's operating instructions will reduce the risk of freezing and other moisture related damage.

Overloading – Damage due to loading, either beyond capacity or improper load distribution, is beyond Airstream's responsibility. Do not overload your vehicles (towcar and trailer) in excess of the permitted weights, see Section A of this Owner's Manual. Load distribution in the trailer has a definite effect upon the towing characteristics and safety, refer to the advice given in Section C2. Reasonable cause to believe damage has been caused by improper loading, hitch set up or improper driving of the outfit could void the Airstream warranty.

Warranty jurisdiction

This warranty shall be governed and construed in accordance with the laws of England/ USA and the parties irrevocably submit to the exclusive jurisdiction of the courts of England/ USA.

Section C – Departure & arrival



Packing lists	C1
Loading	C2
Actual laden weight & nose weight	C3
Hitching up	C4
Departure checks	C5
Arrival	C6
Travel abroad	C7

C1 – Packing lists

ON THE ROAD PACK & OPTIONS

(available from your Airstream dealer)

- Spare Airstream keys
- LPG cylinder(s) – full
- Leisure battery/ batteries
- Portable fresh water container (* 40litre Aquaroll)
- Portable waste water container (* Wastemaster)
- Spare wheel assembly
- LPG hoses to suit the cylinders you are carrying
- Mains water connection hose
- Water plug & filter for portable water container
- Hose or length of rigid pipe for filling portable water container
- Waste water connection hose
- 25amp electrical site connection cable
- Corner steady winder handle
- Fridge winter vent covers
- Airstream entrance doormat
- 13amp socket adaptors for mains hook up lead
- Polarity changeover lead
- LPG hoses for other European countries you may visit

DOCUMENTS

- This Owner's Manual
- Remainder of Owner's pack, including appliance operating instructions
- Warranty documents
- Weighbridge record slips
- Vehicle registration documents incl. CRiS document (UK Airstream owners)
- Driving licence
- Towcar insurance documents (including green card if required)
- Airstream insurance documents
- Breakdown insurance documents
- Passport
- Medical insurance documents
- Pet insurance documents

PERSONAL TOOLKIT & SPARES

(recommended items you will need to purchase)

- Number plate for the rear of the Airstream
- Wheelclamp(s)
- BPW Robstop hitchlock
- Jack
- Axle stand
- Wheel chocks
- Wheel leveling devices
- Torque wrench
- Tyre pressure gauge
- Tyre foot pump
- Towing mirrors
- Fire extinguisher
- Fire blanket
- Small step ladder
- Warning triangle
- Toolkit incl. screw drivers
- First aid kit
- Spirit level
- Spare 12v fuses
- Spare bulbs for road lights – see Section D7
- Spare 12v circulation pump for Alde heating
- 1 litre bottle containing mixed glycol/ water to 50/50 concentration
- Heated towel rail bleeder key
- Toilet paper – low glue content paper, for caravan use
- Spray silicone and WD40 – for lubrication

DOMESTIC

- Adaptors for 230v , if traveling in other countries
- Chargers for phones, cameras, laptops etc.
- Camera, handycam, film
- Medications and toiletries
- Sunglasses and suncream
- Kitchen equipment and food
- Clothes and other personal effects

Pack so that you can reach documents, tools and other essentials without completely unpacking.

Keep a spare set of keys for the towcar in a separate pocket or secure place.

FIRST PRINCIPLES

1. First, check what allowance you have for loading 'personal effects' in the Airstream. This will be stated in the sales brochure.
2. Then compare this to the total weight of the items you wish to take with you. Please take care to ensure that you have allowed for all the masses of items you intend to carry in the Airstream. There is no substitute for weighing everything you wish to take with you, before you start loading, at least the first time you take the Airstream away for a trip.

'Personal effects' are defined as everything aside from what is included in the 'essential habitation' allowance. It therefore includes items such as the water and waste water containers, fresh and waste water connection hoses, wheel chocks/ levelling ramps etc.

Commonly the weight of items you wish to take will exceed the personal effects allowance for items you can load in the Airstream. This is the right time to reduce the quantity of items you take, or choose lighter alternatives.

! CAUTION. Exceeding the Personal Effects allowance risks the Airstream being overloaded. **! WARNING.** Under no circumstances should the MTPLM (maximum technically permissible laden mass) be exceeded.

3. Next, consider what scope you have to place items in the tow car, as opposed to the Airstream. Weighty items, like tools/ cases of drinks or books are best carried in the car, preferably forward of the rear axle line, leaving the Airstream to cope with the bulkier items such as clothing, bedding and empty fresh/ waste water containers.

LOADING THE AIRSTREAM

When loading items you have selected for stowage in the Airstream, try to:

- Evenly distribute the weight of the load around the interior, with any heavy items placed low (close to the floor) and as near to the axle(s) as possible. Stability reduces the further away heavy loads are placed from the centre of gravity (the centre of gravity is just forwards of the axles).
- Keep the weight on each side evenly balanced, so each wheel of the Airstream carries approximately the same weight.
- Only put lightweight items in roof lockers.
- If there are large voids beneath fixed beds, fill these with care – if the bed is positioned to the rear, excess load in the under bed storage space will reduce noseweight and could lead to sway problems. 30kg of additional load in a rear under bed storage space is a sensible maximum.
- Make sure all movable items are well secured.

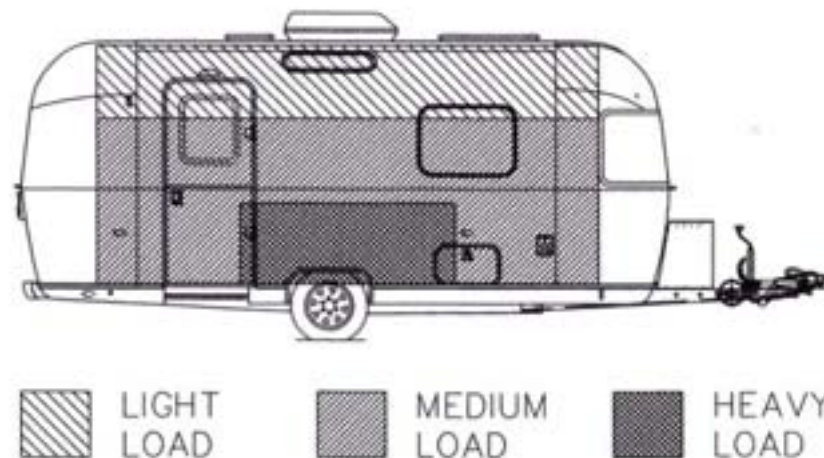

! CAUTION Damage to your trailer caused by overloading, or mounting heavy objects on the rear is considered abuse and is not covered by warranty.

C2 - Loading

TRAVELLING WITH FLUIDS IN ONBOARD TANKS

Water weighs 1kg per litre. It is important to consider the location of any tanks before traveling with any fluids in these tanks.

! CAUTION You should travel with tanks either empty, or full. Travelling with water surging around a half filled tank can have a pendulum effect and cause sway and snaking problems and is therefore not recommended.

Fresh water

All European specification Airstreams have an onboard fresh water tank with capacity of 45 litres, hence when full, the fluid contents will weigh 45kg.

The 'essential habitation' allowance of Payload already assumes that the fresh water tank is 90% full, hence 40.5kg of fresh water is already included in the payload calculation.

By emptying the onboard fresh water tank before you travel, using the stopcock provided (position varies, ask your dealer), you can therefore reduce the actual laden weight by 40.5kg from the Predicted Laden Weight shown on the Weight Information Chart.

Some users with larger tow cars may prefer to travel with the fresh water tank full, so a supply of water is available for rest stops. Before choosing to travel with the fresh water tank full, check the position of the fresh water tank and what effect the additional weight of water may have on noseweight. If the fresh tank is positioned forwards of the axle towards the front of the trailer, travelling with the fresh water tank full will increase noseweight. In this case you should only travel with the fresh water tank full if the resulting noseweight does not exceed the noseweight limit of your towcar or towball.

WC cassette

Generally this is positioned to the rear. This tank is therefore best always emptied prior to travel.

ACTUAL LADEN WEIGHT

You should visit a weighbridge periodically when loaded for travel to check that the weights of the tow car and Airstream outfit do not exceed the various weight limits.

It is all too easy for other family members to keep adding extra items!

You must not exceed either the MTPLM of the Airstream, the gross vehicle weight of the car, or the gross train weight (laden weight of car and Airstream combined).

Keep a copy of a recent weighbridge ticket in your towcar as proof in case you are stopped by Police.

On shorter weighbridges, you will need to weigh the trailer and car separately to know their combined weight, which should be less than the Gross Train Weight.

Position the Airstream on the weighbridge so the tyres of the axle(s) and the jockeywheel at the front will be on the weighbridge platform. Then un-hitch the Airstream and drive the car forwards so it is not loading the weighbridge platform.

ACTUAL LADEN NOSE WEIGHT

Once the Airstream is loaded, check the nose weight.

Generally, more nose weight improves stability (weight is better at the front of a trailer than at the rear).

The maximum permitted vertical static loads for the coupling and drawbar for European specification Airstreams are:

150kg - Airstream 532, 534 and 684

100kg – Airstream 422

However the nose weight limits stated by your towcar and towball manufacturer may well be less than this. Check the maximum load permitted by the towball manufacturer, termed the 'S' value, marked on the towball.

The correct nose weight to try and achieve is therefore the lesser of the maximum allowed for the Airstream (150kg or 100kg), or the nose weight limit for your towcar or towball fitted to it.

MEASURING NOSEWEIGHT

The Airstream should be un-hitched from the towcar and standing level on horizontal ground, with corner steadies raised and handbrake applied.

Place bathroom scales under the coupling head, with a piece of wood fitted between the coupling head and the scales. The piece of wood should be of a length so the Airstream is level with the ground.

Place the piece of wood into the underside of the coupling so it is suspended over the scales. Turn the jockey wheel to lower the front of the trailer, so the piece of wood touches the scales. Keep winding until the jockey wheel is clear of the ground. Record the stated weight.

If the measured laden nose weight of the Airstream is too heavy for your towcar, consider reducing or redistributing loads, or considering a car with a higher nose weight capacity.

! WARNING – Never add excess heavy items to the back of the trailer to reduce noseweight, for example under a rear bed locker, or in a rear wardrobe. Weight behind the axle can magnify any sway that may occur when passing trucks or in gusty winds, increasing the risk of snaking developing.

C4 – Hitching up



Hitching up is one part of the departure procedure.

Following the same sequence of checks each time you hitch up and depart will help ensure nothing is forgotten, so the outfit is fit for the road.

CAR POSITIONING

1. Check the parking brake handle on the Airstream is in the vertical (on) position.
2. Check the 4 corner steadies are in the fully wound up position, into the Airstream chassis.

! CAUTION Always raise the corner steadies before starting the coupling up process. Leaving the corner steadies wound down will overstress the jockey wheel and interfere with the stabilizer operation. If the Airstream is towed away with the corner steadies wound down, particularly the rear ones, the resulting leverage would seriously damage the corner steadies and floor.

3. Check your tow ball is the correct size (50mm), undamaged, clean and free of grease. If the towball is new, remove any paint or anti corrosion coating using fine wet and dry paper, or this will accumulate on the coupling friction pads. The towball surface must be 'bright metal'. Use thinner or spirits to wipe it clean.
4. Check that the jockey wheel tyre is facing aft and parallel to the direction of travel. Manoeuvre the Airstream if necessary so the jockey wheel faces aft.
5. Turn the jockey wheel crank handle to raise the Airstream coupling above the height of the towball on your towcar.

If the jockey wheel has been clamped in too high a position, you may not be able to position the coupling above the towball. You will need to lower the front corner steadies, wind the jockey wheel fully up, loosen the jockey wheel clamp, drop the whole jockey wheel assembly so the wheel touches the ground and tighten the clamp. Then you can turn the jockey wheel crank handle and raise the corner steadies.

6. Reverse the tow car up to as near the coupling as possible, with practice you should be able to position the towball on the car within a few inches of the coupling head on the Airstream.
7. Ensure towcar is left in neutral (manual transmission) or park (automatic transmission) and engage the car parking brake.
8. Turn the jockey wheel handle to lower the coupling, so it is just over the towball. You will likely need to manoeuvre either the coupling or towball a small distance to line them up exactly.

9. On smooth ground, you may be able to manoeuvre a single axle Airstream by hand. To do this, first push the parking brake on Airstream down to the horizontal (off) position.
10. Then take hold of the grab handle on the front of the Airstream and manoeuvre the Airstream so the coupling head is directly above the towball. Then re-apply the parking brake on the Airstream.

! CAUTION Do not move the Airstream by pulling on either the stabiliser handle of the coupling, or the parking brake. This can damage the internal components. Manoeuvre the Airstream only using the grab rails fitted to the front and rear of the Airstream.

11. On uneven or soft ground, or if the Airstream is too heavy for you, you may need to manoeuvre the towball by moving the car. Again with practice this will become easy.

C4 – Hitching up

BREAKAWAY CABLE

Once the coupling is positioned just above the towball and the Airstream parking handbrake is applied, you are ready to connect the breakaway cable.

The purpose of a breakaway cable is to apply the trailer's brakes if it becomes separated from its towing vehicle. Having done this, the cable assembly is designed to part, allowing the trailer to come to a halt away from the tow car.

The fitting of a breakaway cable is a legal requirement in many countries, precise requirements may differ in terms of how the cable can be attached and fines may be levied by police. Always check the requirement with your Airstream dealer.

If the towbar has a designated attachment point (first 2 images below), either pass the cable through the attachment point and clip it back on itself, or attach the clip directly to the designated point.

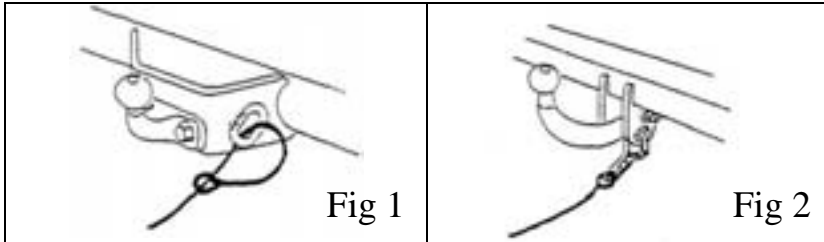

Where there is no designated attachment point, if the towball is fixed, loop the cable around the neck of the towball in a single loop. If the towball is detachable (Fig 3b), you must seek guidance from the towbar manufacturer or supplier.

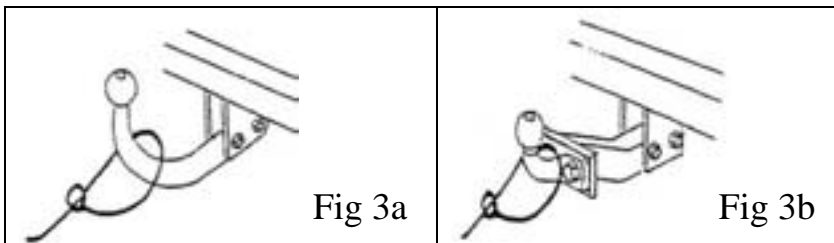

When the breakaway cable is attached, check that it runs as straight as possible, cannot snag (on the trailer coupling head, jockey wheel, or other accessory) and that it is not excessively slack, so it drags on the ground.

Check that there is sufficient slack in the cable to allow the towcar and trailer to fully articulate without the cable ever becoming taut and applying the brakes.

COUPLING PROCESS

12. Once the breakaway cable has been connected, continue with the coupling process.
13. Ensure the handle of the WS3000 safety hitch on the Airstream is raised to the highest position possible (right hand image below labelled 'open').



14. Turn the jockey wheel crank handle to lower the Airstream coupling onto the towball until it fully engages with the towball. This will cause the car rear suspension to drop.

The tow ball head should be no longer visible once the coupling is set correctly.

15. Push down on the stabiliser handle to lock the coupling and activate the stabiliser. The stabiliser handle should now be in the down (horizontal) position.

! CAUTION Wind the jockey wheel down slightly at this point (after engaging the stabiliser). Verify that the rear of the towcar starts to rise without the coupling coming off the towball. This verifies that the coupling is locked securely onto the tow ball.

RAISING THE JOCKEY WHEEL

Single axle models

Turn the jockey wheel winder handle to fully raise the inner tube of the jockey wheel, until the fork arms holding the wheel sit fully within the notches in the outer tube of the jockey wheel.

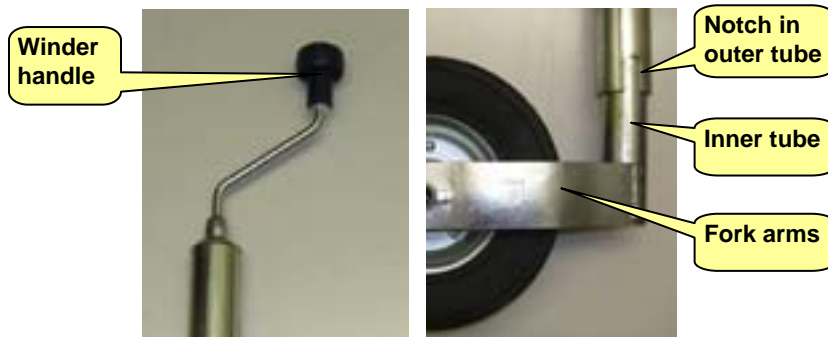

Then turn the clamp handle to loosen the clamp holding the outer tube of the jockey wheel. When the clamp is loose, lift the entire jockey wheel assembly until the wheel sits tight under the A frame cover, so it is parallel to the direction of travel. Then tighten the jockey wheel clamp handle to lock the jockey wheel in the 'up' position.

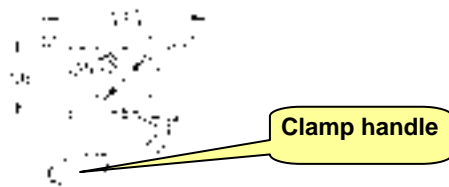

Twin axle models

To raise the jockey wheel of the twin axle model, turn the winder handle until the wheel has automatically folded away and is stowed under the A frame cover.

! CAUTION. Always raise and secure the jockey wheel before travelling. Travelling with the jockey wheel in the down position so it is in contact with the road will cause excess wear to the tyre of the jockey wheel. It will also transmit stresses down the drawbar which could cause damage to the drawbar where it meets the chassis rails.

RELEASE PARKING BRAKE

Push the parking brake handle to the down (horizontal) position, to release the parking brake.

! CAUTION Leaving the handbrake on will cause the brake hubs to overheat risking wheels locking and failure. Always check the handbrake is off before travel.

ELECTRICS

Connect the 13 pin male plug on the Airstream to the corresponding female socket on the back of your tow car.

! CAUTION The towcar electrical connection cable should not be able to touch the ground. The cable can be looped once over the coupling to take up the slack, but do not coil the cable around the handbrake.

Turn on the road lights on your towcar. Walk all around the Airstream to check the Airstream road lights are operational.

TYRES

Visually check the condition of the tyres, looking particularly for small splits in the tyre side wall.

Then check tyre pressures on the Airstream and tow car, using a hand held tyre pressure gauge (keep this in your towcar, together with a tyre foot pump to add air to the tyres if necessary).

See Section E11 for recommended tyre pressures on the Airstream.

C5 – Departure checks

INTERIOR

- TV antenna lowered
- Locking pin fitted to secure TV bracket(s)
- Satellite dish (if fitted) lowered
- Loose articles securely stowed, incl. glass plate in microwave (remove)
- Cupboard and locker doors closed, drawers closed
- Shower door secured, shower ceiling extract fan closed
- Fridge set to 12v operation and fridge/ freezer door lock(s) engaged
- Table secured and catch to stowage compartment engaged (532 model)
- Windows closed (and latches engaged)
- Rooflights closed
- Fresh water tank drained down, if stopcock internal
- WC cassette emptied (if accessed internally – 532 model)
- Bulky items from outside stored inside (like water containers)
- RCD and MCB's on Power Supply Unit turned off
- Heating & aircon fused spurs turned off
- Control panel POWER button turned off (unless Alde heating to be used)
- Tracker motion sensor switch turned off

EXTERIOR

- Trailer entrance door locked (both locks)
- Entrance step stowed
- Connecting cables, hoses etc. all stowed and compartment doors locked
- WC vacuum cassette emptied (if accessed via external compartment door)
- Gate valve to waste piping opened and left in open position
- Verify Zipdee awning arms are locked for travel
- Verify TV antenna and satellite dish (if fitted) is lowered
- Verify all rooflights and windows are closed and latched
- Corner steadies raised
- Number plate fitted to rear of Airstream
- Visual and inflation pressure check of tyres
- Wheel nuts torque checked following wheel change/ service/ storage etc.

DRAWBAR AREA

- LP cover latch engaged, locked and bungee cords fitted
- Coupling locked with stabiliser handle in the fully down position
- Breakaway cable fitted
- Trailer handbrake in the off (fully down) position
- Jockey wheel fully raised and clamp handle tightened
- 13pin electrical towing connector plug connected to towcar

TOWCAR

- Towing mirrors fitted
- Tyre pressures checked

FINAL CHECKS

- Turn car road lights on, then verify all trailer lights are working
- Walk around Airstream – all windows closed and entrance door locked
- Distant view of Airstream roof – all rooflights & equipment closed/ stowed

MOVING OFF CHECKS

- When satisfied all tasks are complete, proceed to move the outfit off the pitch.
- When onto hard ground, stop to test the brakes.
- Check the ground when the outfit was parked for forgotten objects.

WHEEL NUTS & BRAKES

The torque of the wheel nuts should be re-checked using a torque wrench after approximately 25 miles or 30 minutes of travel, on any of the following occasions:

- on your first trip following collection of the Airstream
- after winter storage
- after servicing
- following replacement of a wheel

The brake system should be checked after 500km/ 300 miles when the Airstream is taken on its first run when new, or after annual service.

SUITABILITY OF PITCH

On arrival at the campsite, inspect the allocated pitch for obstructions, the layout of services (proximity to any drainage/ water/ electrical services), the gradient and ground conditions, before positioning/ reversing onto the pitch.

Where possible, choose campsites or camping locations where the Airstream can be parked on level, hard ground. Hard standing is ideal for this reason.

Be wary of positioning the Airstream on uneven or soft ground, for the following reasons:

Uneven ground. Uneven ground can cause problems hitching up (especially for twin axle models that have the fold away jockey wheel), if sloping ground results in the tow ball of the tow car being lower or higher than the normal coupling height. Carry a jack so you can safely lift the front of the Airstream if required.

Soft ground. The noseweight of an Airstream tends to be higher than for a white box type caravan of similar size. Higher noseweights can cause problems with jockey wheel tyres sinking into soft ground. In addition, the wheels of the driven axle(s) of the towcar will tend to spin on soft ground.

Grass sites should be checked to identify possible soft ground before you proceed to take the Airstream onto the site.

After positioning/ reversing onto the pitch, check again that the proximity to any services (drains/ water/ electricity) is acceptable, that hoses & cables will reach.

LEVEL SIDE TO SIDE

Side to side levelling is best achieved by manoeuvring the Airstream onto wheel ramps or similar levelling devices, when it is still connected to the tow car.

For twin axle Airstreams, you will need two small ramps each side, such as the 'Froli Small' ramps from Milenco (www.milenco.com). For single axle models, a larger adjustable device can be used, such as the 'Froli Adjustable'.



A spirit level placed on the entrance step is a useful aide when levelling.

UN-COUPLING

Once the Airstream is in position and levelled side to side, engage the parking handbrake by lifting the parking brake handle to the vertical 'on' position.

Un-couple the electrical 13pin cable.

Lift the stabiliser handle to the fully up (open) position before the jockey wheel is wound down fully to the ground. Using one hand, lift and hold the handle of the WS3000 safety hitch to the highest position possible.

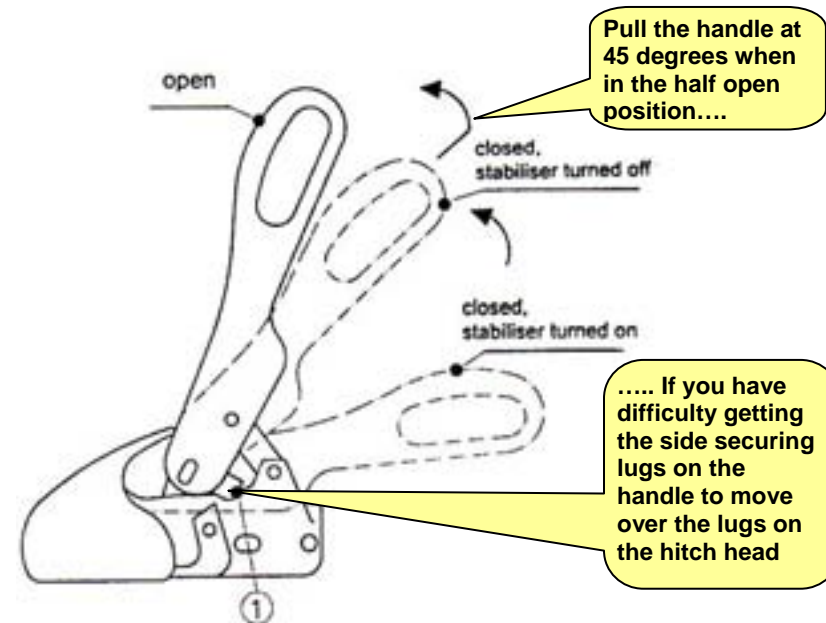

Only when the stabiliser handle is in the fully up/ open position, should you wind the jockey wheel down to touch the ground and start lifting the hitch head off the towball.

If the hitch is being subjected to vertical pressure, before the stabiliser handle is lifted, this can prevent the stabilizer handle lifting and the coupling disengaging.

For the same reason, do not lower the front corner steadies until the stabiliser handle has been lifted to the fully up position and the jockey wheel wound down to lift the hitch off the towball.

C6 – Arrival

LOWERING THE JOCKEY WHEEL

Then follow the instructions below to lower the jockey wheel, to raise the coupling off the towball, until it is clear of the top of the towball.

Then disconnect the breakaway cable.

Finally drive the towcar forwards.

Twin axle models - jockey wheel

Each time the jockey wheel is wound down, check that the back bar of the foldaway hinged wheel assembly has engaged correctly on the grooved support shown in the photo below. If the car towball height (ground level to middle of the towball) is below 400mm, the risk of this happening increases.



! WARNING Check each time the jockey wheel is wound down to lift the coupling off the car towball, that the back of the foldaway wheel engages on this grooved bar, before the jockey wheel takes load.

! WARNING Do not wind the jockey wheel down to lift the front of the Airstream unless the foldaway wheel of the jockey wheel is correctly engaged, as shown in the image above.

If the coupling of the Airstream is too low for the foldaway wheel to engage correctly, either raise the rear of the towcar (if the car has air suspension allowing the ride height to be set to a higher off road setting), or use a jack to lift the front of the Airstream, so the foldaway jockey wheel will engage.

Single axle models – jockey wheel

Loosen the clamp handle and lower the whole jockey wheel assembly until the jockey wheel tyre is approximately 30-50mm from the ground. Tighten the clamp handle.

! TIP Don't drop the jockey wheel assembly fully to the ground. Stop when the tyre is 30-50mm above the ground. This will make it easier to hitch up again later.

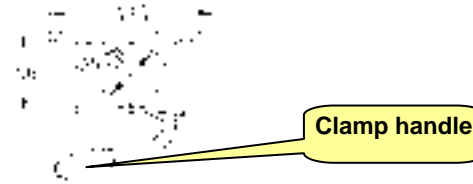

Then turn the jockey wheel winder handle so the inner tube extends down to touch the ground.



Minimise this distance to reduce the risk of damage. The more inner tube of the jockey wheel is wound out, the greater the risk of it bending.

LEVEL FRONT TO BACK

Level front to back by using the jockey wheel to raise or lower the front of the Airstream, sighting by eye or using a spirit level if desired.

When the trailer is level, lower the 4 corner steadies using the winder handle provided to 'steady' the levelled Airstream.

UNPACK & SECURE

Unlock external compartment doors to remove equipment including water, waste and electrical hoses and cables.

Open trailer entrance door and pull out the entrance step.

Open windows and rooflights as desired to provide natural through ventilation.

Fit a wheelclamp and hitchlock as a security precaution.

PARKING BRAKE

For periods up to say 2 weeks, which will cover normal use for trips/ holidays etc., the parking handbrake can be left in the 'on' position.

For longer periods, for example when in storage, leaving the parking handbrake in the 'off' position, will keep the brake shoes off the brake drum and prevent any possible corrosion of the brake surface.

However before leaving the Airstream in storage with the parking handbrake in the 'off' position, first ensure that the site is reasonable level, the corner steadies are wound down and the wheels are chocked.

STABILISER HANDLE

When the Airstream is un-coupled and parked, the coupling stabiliser handle should be put in the down (horizontal) position.

This will prevent other well-intending people using the stabiliser handle as a grab point when helping to manoeuvre the Airstream, which risks damaging the stabiliser.

Either push the safety ball firmly into the towball space (**left photo below**) and slowly lower the stabiliser handle.



Alternatively, insert a finger under the coupling head as shown in the **right photo above** and pull the movable hinged jaw of the coupling forwards, whilst lowering the stabiliser handle.

C7 – Travel abroad

SPEED LIMITS

Research permitted speeds and road laws before you travel - purchase a touring handbook such as the 2 part [Caravan Europe](#) published by the Caravan Club (www.caravanclub.co.uk), which lists speed limits.

OTHER ROAD LAWS

Other common road laws within some EU countries include:

- requirements for use of winter tyres in winter months
- restrictions on use of outside lanes of dual carriageways and motorways when towing
- specific requirements for connection of breakaway cables etc.

Check what other requirements may exist BEFORE you travel, by speaking to your local caravan club helpline.

INSURANCE

If you are travelling within Europe, you should notify insurers prior to departure and confirm if any additional cover is required – the minimum necessary is a “green card” covering legal liability to 3rd parties.

Full comprehensive cover is preferable, most insurance companies will charge an extra supplement for this. You may also wish to have a tracker device fitted to your towcar, depending on its value.

BREAKDOWN ASSISTANCE

If travelling in continental Europe, again normally additional cover is required.

For example the AA European breakdown is an annual policy (up to 90 days each trip) covering car and Airstream, covering repairs, accommodation, alternative car and recovery of car and Airstream back to the UK if required.

CHOOSING CAMPGROUNDS

When making a booking for a campsite, particularly in continental Europe, ask what electrical supply is available (in amps). This will determine what mains electrical equipment can operate, or operate simultaneously, without tripping the campground fuses.

Most UK commercial sites offer a 16amp supply to each pitch, which will be sufficient to run most combinations of 230v equipment.

Some private campgrounds in continental Europe have much lower rated electricity supplies, offering only 3-5amps, which may not be sufficient for operating more power hungry devices such as air conditioning.

ADDITIONAL NOTES:

Section D – Maintenance



Modifications	D1
Cleaning the exterior	D2
Maintenance Schedule	D3
Annual Service	D4
Autumn Frost Protection	D5
Winterising	D6
External lighting	D7

D1 - Modifications

Generally, any modifications of the Airstream, by anyone other than an authorized Airstream dealer, are not recommended.

CAUTION. Airstream Inc. reserve the right not to approve a warranty claim if the original construction of the Airstream has been tampered with or repaired other than by Airstream Europe Ltd, or an Airstream dealer or service workshop approved by Airstream Europe Ltd.

Never conduct do it yourself modifications on electrical or LPG (liquid petroleum gas) systems.

Do not allow modification of electrical or LPG systems and appliances except by qualified persons.

Any replacement parts for an appliance shall conform to the appliance manufacturer's specifications and should be fitted by him or his authorised agent.

The BPW chassis is designed and built to precise tolerances and must not be drilled or welded. When fitting spare parts to the chassis including the axles, brakes, coupling etc., only genuine BPW parts may be used. This is to ensure the type approval retains its validity in accordance with national and international regulations.

Regular washing of the outside of the Airstream is essential to keep it in good condition. You should wash the exterior of the Airstream not less than every month and apply wax in the Spring and Autumn. In coastal areas where the finish is exposed to salt air, or in polluted industrial areas, we recommend more frequent cleaning and waxing.

Ideally however you should wash the exterior after each trip.

This is especially necessary in winter to remove road salt. Salt left on the bodyshell will speed corrosion of sharp edges of aluminium where the clearcoat weathers quickest.

It is also important to remove sap, resin, asphalt and other sticky residues as soon as possible after they appear by washing and waxing. Sunlight and time will bake harden these materials, making them almost impossible to remove without heavy buffing.

Wash the Airstream in the shade, or on a cloudy day when the aluminium is cool.

Pre-rinse. First rinse all grit and large particles of dirt from the surface. Spray all surfaces with fresh water using a hose with spray attachment.

Wash. Then remove oil, grease, dust and dirt by washing. It is best to again use a hose, connected to an auto style broom attachment with soft bristles (preferably with extending handle, for reaching the upper parts of the Airstream shell), thus ensuring a constant supply of fresh water onto the aluminium.

Fill a bucket with non abrasive soap or detergent (diluted according to manufacturer's instructions). Dip the broom in the soapy water as required to keep the broom head soapy and then apply to the Airstream without excessive pressure.

Brush each aluminium panel in the direction of the grain of the metal, this helps prevent any fine scratches that occur bring visible. Never rub hard on the coating.

CAUTION: Do not wash the Airstream using a sponge and bucket, each time you return the sponge to the bucket, you will transfer dirt particles into the wash water, which then will be transferred to the sponge and scratch the aluminium as you rub the sponge on the Airstream body. Do not use abrasive polishes or solvents.

Rinse. Next rinse the cleaned trailer thoroughly with clean water, using the hose with spray attachment as per the initial rinse.

Dry. Drying with chamois or soft cloth may prevent streaking and spots. When drying or applying polish, always wipe with the grain of the metal.

Wax. After washing and drying, applying a wax will increase the life of the finish, protect the shell from minor scratches and make subsequent cleaning easier.

The caulking and sealant used in external seams and joints such as end shell segments and around window frames, light bezels, the rub rail (at floor level) etc. should be checked regularly. If this material has dried out and become cracked, or if a portion has fallen out, it should be replaced with fresh materials to prevent possible rain leaks. Caulking and sealants are available from your Airstream dealer.

TIP: Internal inspection following external washing is good practice to check for any possible leaks. Clues would be water running down the internal surfaces or pooling on flat surfaces.

D3 – Maintenance schedule

ISSUE	USER CHECKS		SERVICE ENGINEER Annually
	Each trip/ monthly	Annually	
Tow car	Clean towball - free of paint/ dirt/ grease. Tyre inflation pressures	13pin socket on towcar - inspect pins, spray silicone grease, road light test Towball - visual check for rust/ stress, torque bolt connections	
Tyres	Tyre visual condition & inflation pressure		Remove wheel/ tyre assemblies, including spare wheel. Inspect all tyres closely for uneven wear, cracks, bulges etc. Check tyre inflation pressures.
Wheels	Wheel nut torque		Wheel nut torque
Suspension			Ride height - visual check before wheels removed, then measure drop arm positions after removing wheels to check suspension not reduced Shock absorbers - visual check for oil leakage & evidence of stress Lubricate - grease nipples on torsion axle
Hitch			Hitch damper action - verify hitch head rebounds when pushed in, no evidence of oil leakage. Lubricate - grease nipples top of hitch casing (x 2) and handbrake spindle (x1) Friction pads in hitch head - check wear indicator, visual check for dirt build up, clean with 150 grit/ brake cleaner
Brakes			Bearings. Small brake (up to 1500kg) - check wheel play. Over 1500kg brake - remove, wash & re-pack taper roller bearings in grease. Brake linings. Remove all brake drums and check wear to lining of brake shoes (min 2mm). Replace 'one shot' hub nuts and torque to specified setting. Wheel brake. Adjust wheel brake adjuster nut so each bowden cable pulls out 5mm. Brake rod turn buckle - adjust brakes to remove freeplay, so brake ratio bar just touches back of hitch drawtube. Handbrake. Function test. Breakaway cable. Check for wear.
Chassis			Visible check of bolts where A frame and axle connect to chassis rails. Corner steadies. Clean winder spindles and apply spray silicone.

D3 – Maintenance schedule

ISSUE	USER CHECKS		SERVICE ENGINEER Annually
	Each trip/ monthly	Annually	
Water	Drain down water heater monthly if Airstream in continuous use Drain down if Airstream in storage and risk of freezing		Drain down cold & hot water systems. Clean water filter on Aquasmart board. Replace carbon filter on Plug & Filter. Inspect O rings to spigot of water inlet socket. Check accumulator tank pressure (if fitted). Inspect fresh water tank and clean as required. Air pressure test for leakage. Re-fill system, confirm pump auto shut off when filling onboard tank. Verify no leaks and no pump cycling. Drain down and leave winterised, unless agreed otherwise with customer.
Gas			Inspect LP hose condition. Replace O rings. Check tightness of hose connections. Check expiry dates on LP hoses. Gas soundness test & certificate.
Heating	Heating system fluid level in expansion tank		Heating system fluid level in expansion tank. Additional works every 2nd year: <u>Drain down & replace heating system glycol mix (unless long life glycol used - replace every 5th year)</u> Boiler flue air inlet and exhaust outlet unobstructed, clean and hose connections tight. Function test, bleed system as required until hot throughout.
Electrical	Leisure battery state of charge Smoke alarm function		13pin plug - inspect pins, spray silicone grease, road light test Additional works every 2nd year: Inspection, test & certificate on 230v installation 12v lights - replace any blown bulbs/ defective fittings Smoke alarm - vacuum to remove dust & replace battery
Appliances	Clean toilet seal to ball valve	Clean cooker extractor filter, clean all appliances	Clean all O ring seals. Verify toilet flush & isolation switch. Cooker - hobs, oven and grille ignite on gas. Fridge – Clean gas burner. Verify 230v and gas operation. Aircon – Clean drain holes to external casing, clean filters.
Interior			Drawer, cupboard & locker handles, catches & hinges, none loose Window & roof blind operation
Door/ window catches			Trailer entrance door & screen door, adjust fit & lubricate. Check window catch adjustment & lubricate.

NOTE: The above schedule is provided as an aid to planning maintenance, but should not be relied upon as being all inclusive. Read the remaining sections of this Manual which incorporate more detailed maintenance recommendations for the different major components/ systems/ appliances.

Most owners do not possess expert knowledge of trailer systems and maintenance requirements, or have the time or inclination to undertake effective annual servicing.

It is strongly recommended that the Airstream is serviced not less than once a year by an Airstream dealer, or recognised Approved Workshop.

Servicing is best undertaken in the Spring, after winter and before more intensive use in the Spring/ Summer months.

Your Airstream dealer will be familiar with all aspects of the construction of the Airstream, be able to undertake any works or repairs necessary and be more likely to have all/ any necessary parts in stock.

A full list of tasks performed during a service can be provided by your Airstream dealer on request. A Service Certificate is usually provided on completion, listing the tasks performed.

Section M1 of this manual allows each service undertaken to be recorded, to build up a service history for you/ a future owner. Example:

<p>SERVICE</p> <p>DATE:</p> <p>Annual service carried out in accordance's with manufacturer's recommendations</p> <p>DEALER STAMP</p>
--

Customers located some distance from their Airstream dealer may also like to use a local caravan dealer for servicing and other minor tasks. If possible, choose a company who sell caravans using BPW chassis and running gear, as they will be used to servicing the BPW equipment found on the Airstream.

In the UK, use a company who are members of the NCC Approved Workshop scheme, which requires 50% of service staff to hold a minimum standard of training, such as the City & Guilds Certificate in Caravan Engineering. This will ensure that the workshop staff are competent and up to date with the relevant procedures and regulations. To find an Approved Workshop in the UK, visit: www.approvedworkshops.co.uk.

Approaching winter brings the risk of frost and freezing temperatures.

Before the end of September, or at the earliest warning of frost, you need to decide how the Airstream is to be used and stored over the winter. You have 2 options:

1. Continued regular winter use. If you intend to use the Airstream regularly during winter months, with the water system filled and ready for immediate use, you will need to:
 - EITHER store the Airstream inside in a heated building,
 - OR it can be stored outside if you provide a permanent 230v electrical mains hook up and set the Alde heating to operate at all times, with the thermostat set to say minimum 5 degrees Centigrade.

This will ensure that the heating comes on if the ambient temperature nears or drops below freezing, to protect the systems freezing. It is also good practice in any event to prevent the accumulation of moisture internally and excess fluctuations in temperature.

If you choose this option, you need to be very confident of the heating remaining on continuously to give freezing protection. Can you be sure that the heating will not be tampered with - for example someone pulling out an electrical plug or similar?

2. Occasional or no winter use. If you intend to use the Airstream only occasionally in winter, or not at all, or do not have the ability to store the Airstream inside or provide a permanent 230v electrical supply, then you will need to winterise the trailer.

You will then need to re-commission the fresh water, waste water and 12v electrical systems each time you wish to use the trailer in winter months.

If you are in any doubt as to which option to choose, we would recommend you drain down the water system and follow the other precautions for winterising the trailer.

! CAUTION Failure to adequately protect against freezing, either by draining down the water and waste systems and removing the battery/ batteries, or setting the heating system to provide permanent freezing protection, risks damage to the systems and consequential damage to the trailer and this is not covered by warranty. Frost protection is the owner's responsibility.

DRAINING DOWN THE WATER SYSTEM

Turn off the water pump at the 12v digital control panel.

Open all taps until no water flow. In the case of single lever taps, move the tap to midway between hot and cold and lift to the open position, then leave tap in open position.

Open all showers to 'on' position. Un-clip shower heads to internal and external showers (including pull out shower heads to wet baths, which should be pulled out fully). Depress any hand spray levers while holding down into the shower tray/ onto the ground respectively, until there is no further water flow.

Depress the WC foot pedal.

Open cold water drain down point - lift yellow lever of cold water tank drain down, usually positioned near to onboard water tank (if fitted).

Drain the domestic hot water tank in the Alde boiler. Lift the yellow lever to the drain down point, which is usually positioned close to the Alde boiler.

Select FILL position on 3 way water system switch.

Press on/ off button to turn on 12v digital control panel and then turn on the water pump at the digital control panel.

Leave for 30 seconds, then turn 3 way switch to EXT position and leave for another 30 seconds.

Then turn the water pump OFF.

Access the waste water bellypan compartment. Pull gate valve and leave in fully out (open) position, to drain any water from waste water piping.

! CAUTION If water is allowed to freeze in the system, serious damage to the water heater, pipework and pump will occur.

OTHER WINTERISING PRECAUTIONS

Remove the plastic cover to the side of the WC foot pedal, then unscrew the white threaded lock nut located underneath the pedal. Press the pedal again. Once water has drained out of the toilet bowl, screw the lock nut on again.

Remove WC vacuum cassette, empty completely, flush with clean water, leave to drain and then return to the trailer, or store indoors.

Fill P traps to galley sink, bathroom wash hand basin and shower tray with antifreeze, diluted to manufacturer's instructions.

Remove the leisure battery/ batteries and store indoors in a cool dry place where there is no risk of freezing. Connect the battery/ batteries to a trickle charger during the winter storage period, to keep them fully charged.

! CAUTION Removing the leisure battery will trigger the satellite tracking system, if one is fitted. Before disconnecting the leisure battery, telephone the control centre and quote the device number for the tracker fitted to the Airstream. If no leisure battery is connected over winter months, the satellite tracking system will not remain operational.

Clean out fridge and leave fridge door wedged open to ensure circulation.

Leave furniture doors and lockers open to allow air to circulate fully.

Remove soft furnishings including seat cushions, mattress, curtains and store inside in a heated space. If this is not possible, stand the cushions/ mattress on their edges to improve circulation of air.

D7 – External lighting

Side marker light:



LED unit, maintenance free

Hella: 2PS 964
295-061

Porch light:



LED unit, maintenance free

Front Position light:



Jokon 11.1001.001
Bulb: C 5W;
E1 0221653

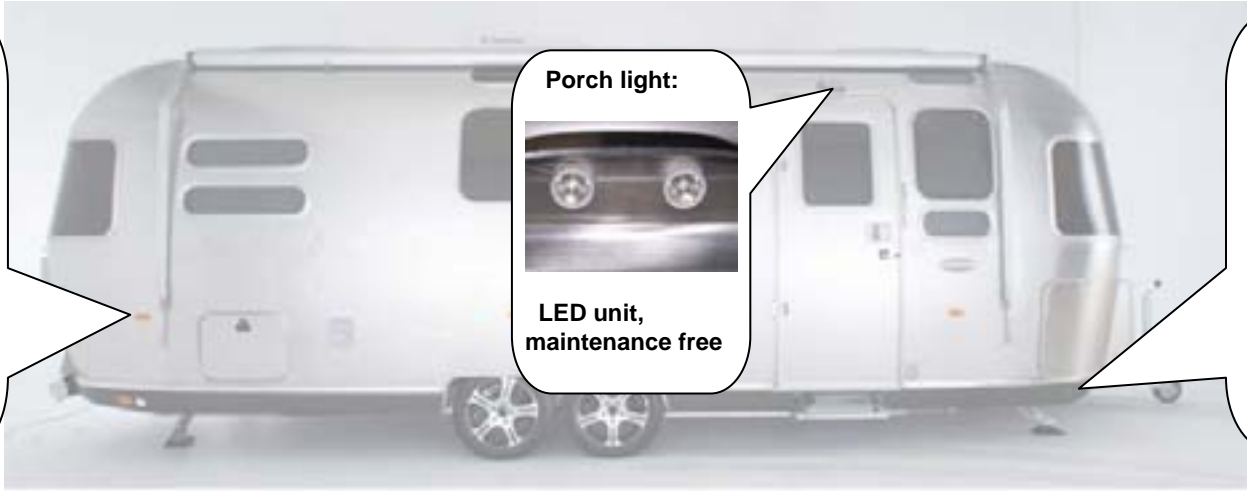

Airstream International, door side view

Outline marker light:



Jokon 12.0007.000
Bulb: R5W;
E1 0231426

Service light:



Sealed LED unit. Truck Lite (USA)



Airstream International, non door side view

D7 – External lighting

EITHER:
Incandescent 6" oval tail light:



Sealed unit – whole fitting replaced if bulb fails

OR:
LED 6" oval tail light:



All Airstream parts

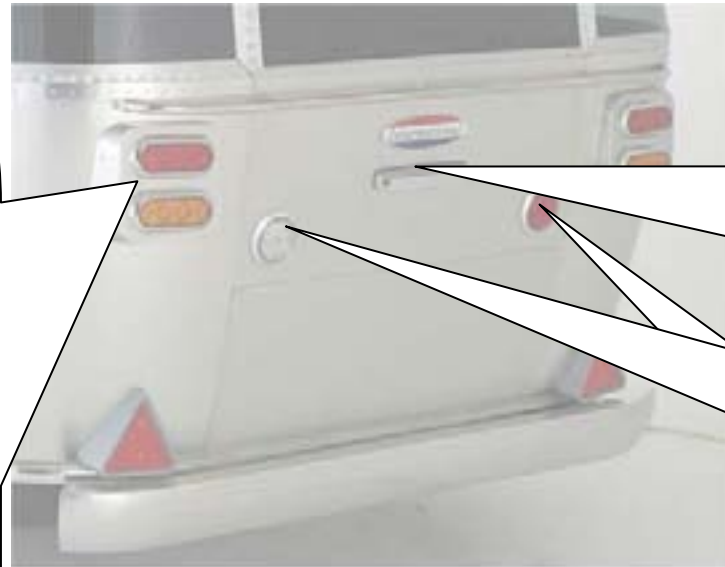

Airstream International, rear lighting



Airstream Bambi, rear lighting

Number plate light:



Jokon 13.4003.100
Bulb: 2 x C5W: E1 22817

Fog & reverse light, both Jokon:



Combination Jokon taillight:



Jokon
10.2050.130 (left combination lamp)
10.2050.140 (right combination lamp)
Bulbs: various



Section E – Chassis & running gear



Overview	E1
Hitch & coupling	E2
Coupling & hitch head	E3
Jockey wheel	E4
Brakes	E5
Suspension	E6
Tyres	E7
Spare wheel & jacking	E8
Wheel changing	E9
Maintenance	E10
Components & tyre pressures	E11

E1 - Overview

Typical European specification Airstream chassis & running gear (version pictured has rubber suspension axle, as opposed to torsion axle):

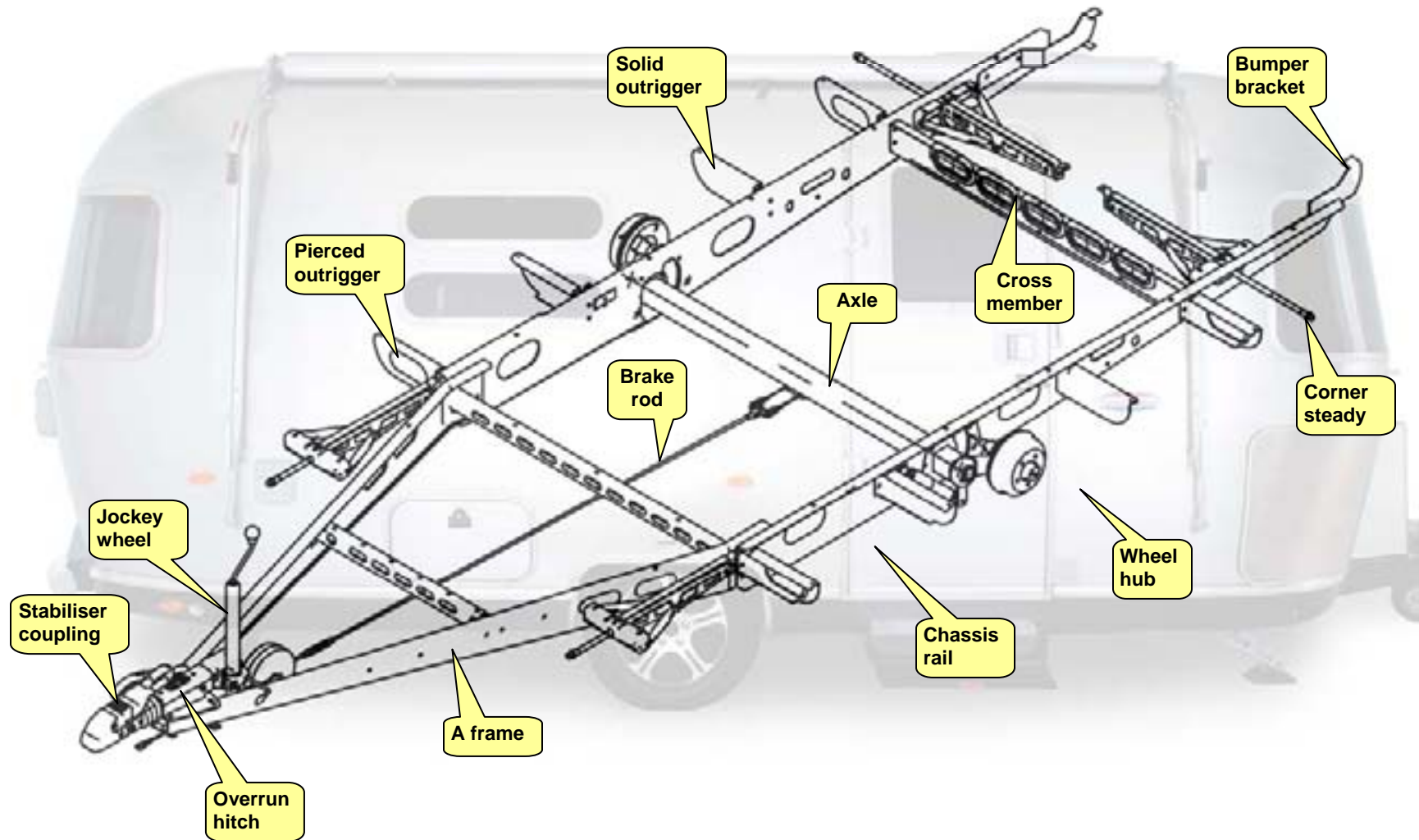

ZAF OVER RUN HITCH WITH WINTERHOFF WS-3000 STABILISER COUPLING

OTHER VIEWS

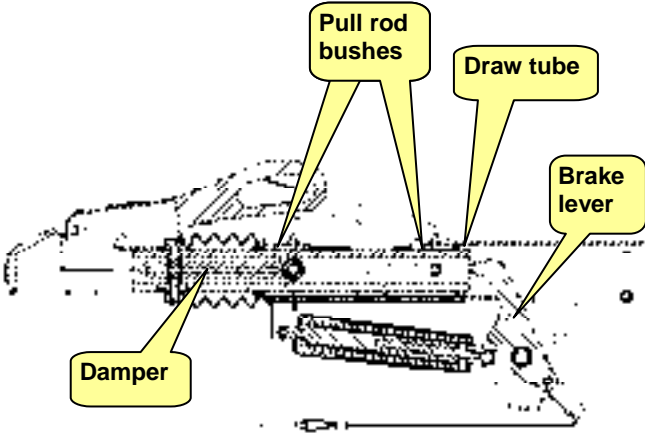
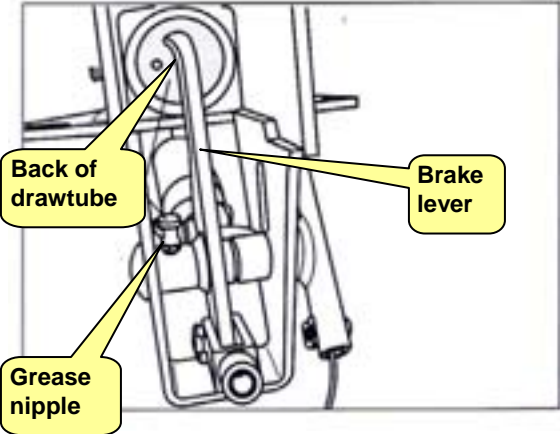
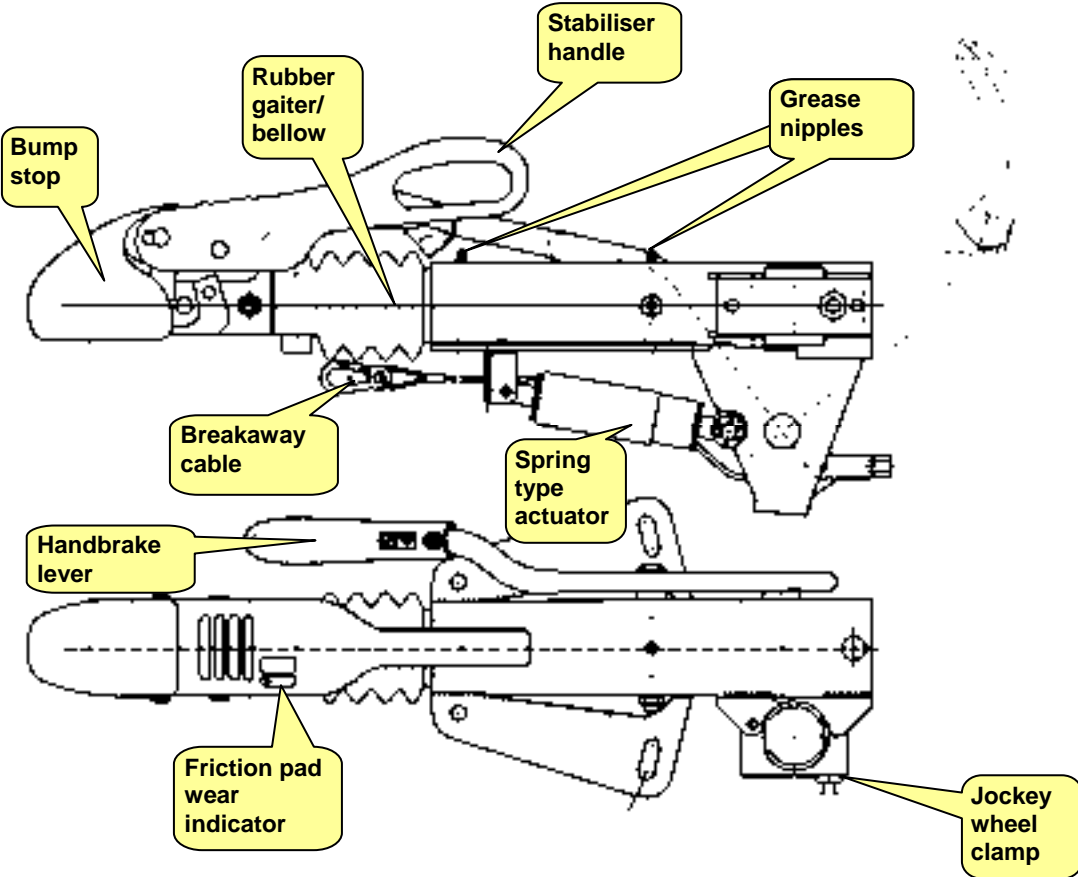

E3 – Coupling & hitch head

WINTERHOFF WS3000 STABILISER COUPLING

The handle of the stabiliser coupling has 3 positions as shown below:

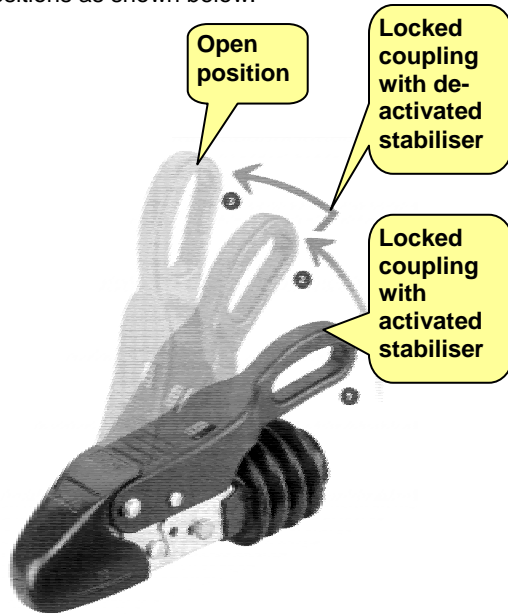

CAUTION! The stabiliser handle must **ONLY** be used for releasing and applying the coupling. **Do not use it as a grab point when manoeuvring the Airstream.** This will break the springs and/ or the plastic handle and this damage is not covered by warranty. Similarly the handbrake lever must not be used as a manoeuvring aid.

The stabiliser coupling is fitted with spring-loaded friction pads which enclose the towball from the front and rear. This reduces pitching and snaking movements of the trailer. Optimal damping is achieved with new friction pads after a certain run-in period.

FRICITION PADS

When the handle of the stabiliser coupling is pushed down, springs in the coupling create pressure forces on friction pads set into the coupling head, which grip the towball.

These friction pads require periodic replacement. Inspect the wear indicator on top of the stabiliser handle (image below).

This is best done when the Airstream is coupled to the towcar and the stabiliser handle is in the fully down position, so the stabiliser is activated.



The coupling is factory set so the pin visible in the oblong hole is positioned under the + symbol when new friction pads have been fitted. When the pin moves to the – symbol, the friction pads should be replaced. New friction pads can be purchased from BPW, or your Airstream dealer.



HITCH DAMPER

The damper is a key component of the hitch. The damper absorbs the shunting loads during normal slow braking and emergency stops.

The damper is located inside the draw tube. Both parts are contained/ concealed in the hitch casing.

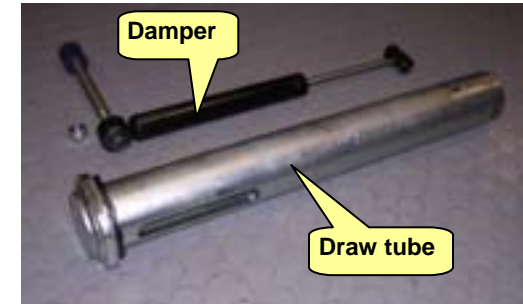

Typical life of the damper is approximately 7 years. Over time, the seals will fail, which then allows the oil or nitrogen gas in the damper to escape.

If when the hitch head is pushed aft, it does not return/ rebound, this is a sign that the damper may need replacing.

Oil leaking at the front of the hitch would also indicate deterioration of the damper and the need for service attention by a BPW trained technician.

PARKING HANDBRAKE

To apply the parking handbrake, lift the handbrake lever from the horizontal (down) position to the vertical (up) position.

CAUTION! With the parking brake activated, the Airstream can roll back about 30cm until the braking force takes full effect. Hence, do not park too close to obstacles.

TWIN AXLE

Twin axle European specification Airstreams use a Winterhoff jockey wheel rated to 250kg, with automatic fold away wheel, fitted with a solid rubber tyre.



WARNING! See warning given in Section C6 regarding the operation of the foldaway wheel of this jockey wheel.

CAUTION! The wheel used incorporates roller bearings and should only be replaced (in the event of damage) with one of matching type from BPW, which incorporates roller bearings.



Roller bearings

SINGLE AXLE

Single axle 2010 European specification Airstreams use a Winterhoff jockey wheel rated to 200kg. This design has an outer tube which passes through a clamp, which is tightened with a turn handle.



Clamp with turn handle



Air filled tyre (after market option)
Winterhoff # 5432



Jockey wheel assembly

SOLID RUBBER OR AIR FILLED PNEUMATIC TYRES

All European specification Airstreams are supplied with a solid rubber tyre fitted to the jockey wheel.

Air filled/ pneumatic tyres for jockey wheels are available in the after market. The air filled tyre gives a softer ride. Disadvantages are the risk of punctures and the need to regularly check the tyre inflation pressure.

Single axle models can have a wheel with air filled tyre (Winterhoff # 5432) fitted to the existing jockey wheel, as a replacement for the wheel with solid rubber tyre.

Twin axle models would require a complete new jockey wheel assembly (Winterhoff # 3855), which has wider axle forks to the foldaway wheel, to accommodate the wider air filled tyre.

E5 – Brakes

The braking system, which is part of the chassis supplied by BPW, is made up of several components:

- Over run hitch
- Transmission rod and cables
- Wheel brake (BPW's wheel brake is a drum brake)

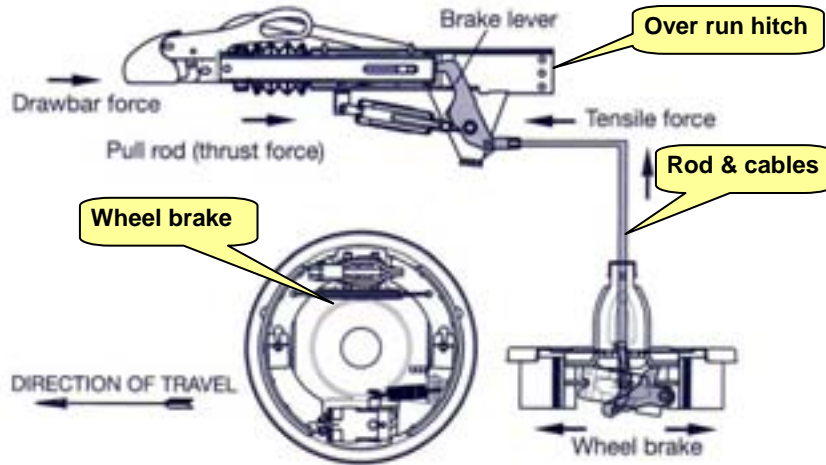

Axles up to 1500kg are fitted with a brake with a maintenance free compact bearing. This bearing requires no maintenance at service, other than to check for wheel play, which would indicate the bearings are worn. This brake is used for the Airstream 422 (MTPLM of 1500kg) and tandem axle models, which use 2 x 1350kg axles, each fitted with the smaller brake.

Axles over 1500kg have a different brake fitted, with 2 x taper roller bearings. These do need maintenance (washing & re-pack with grease) at the annual service, or every 5000km.

Linings to brake shoes of both the above brake types need inspection at the annual service, to check that there is at least 2mm of wear remaining.

CAUTION! Brake inspection, maintenance and adjustment should be undertaken only by a trained service technician.

SMALLER BRAKE (AXLES UP TO 1500KG) WITH COMPACT BEARING

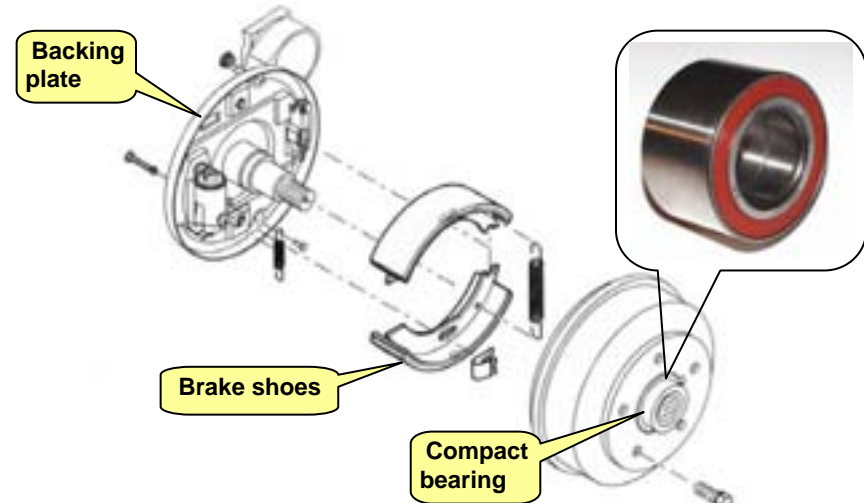

LARGER BRAKE (AXLES OVER 1500KG) WITH TAPER ROLLER BEARINGS

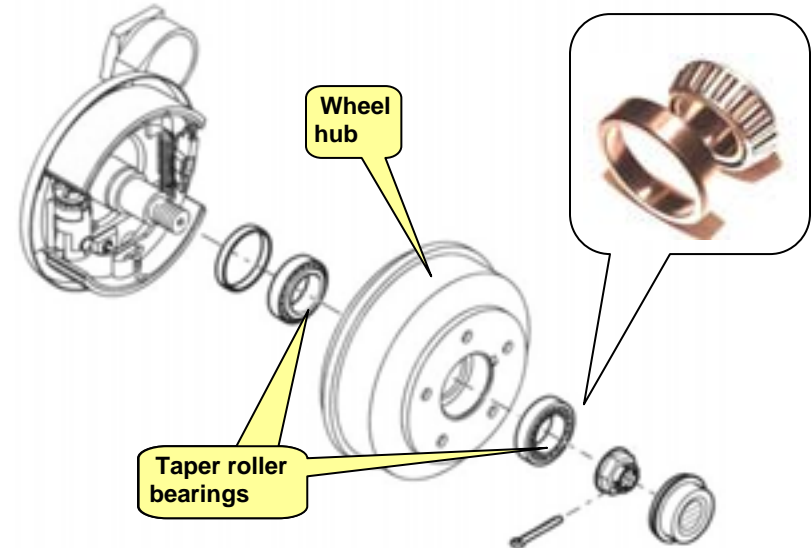

TORSION BAR AXLES

BPW's torsion bar axle is used on the Airstream 684, 534 and 532. A torsion bar axle gives a softer ride, than the rubber suspension axle. Each torsion bar axle has 2 torsion bars, one at each end.

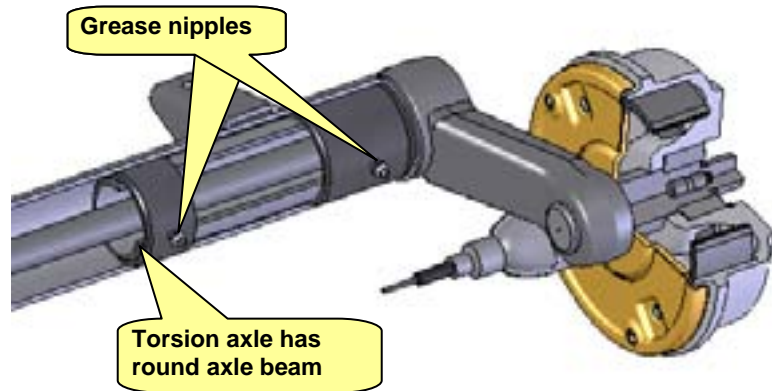

The torsion bars themselves are steel rods, with spline ends (**photo below**). Each torsion bar can be removed and replaced if necessary, plus the spline ends allow the ride height to be altered relatively easily. Torsion axles requires seasonal greasing via grease nipples on the axle beam.



Load compensation torsion axles are used for the twin axle models. These allow equal distribution of weight between both axles, ensuring optimum stability.

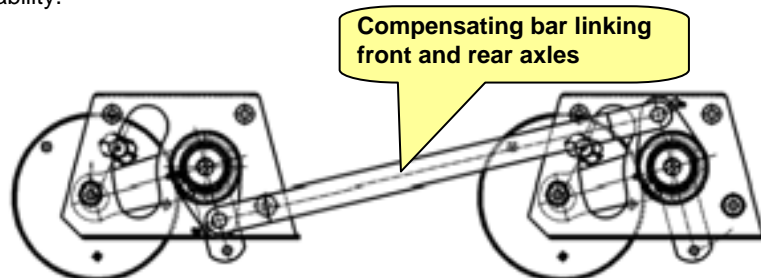

RUBBER SUSPENSION AXLE

BPW's rubber suspension axle is used for the Airstream 422. The axle has 4 pieces of rubber, which are compressed as load is applied. The rubber suspension axle does not require maintenance.

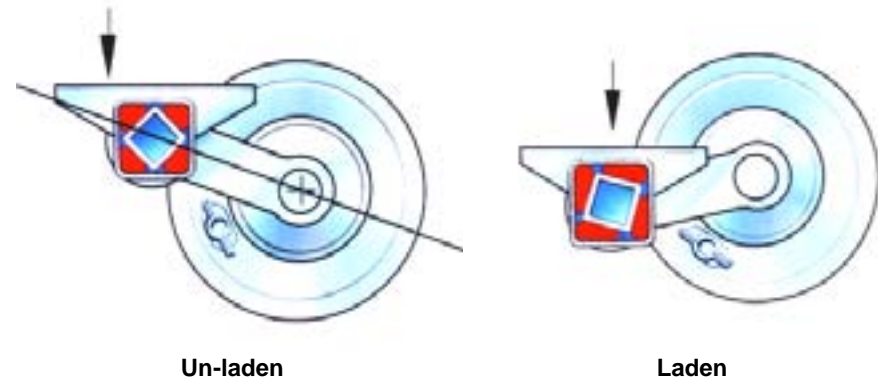
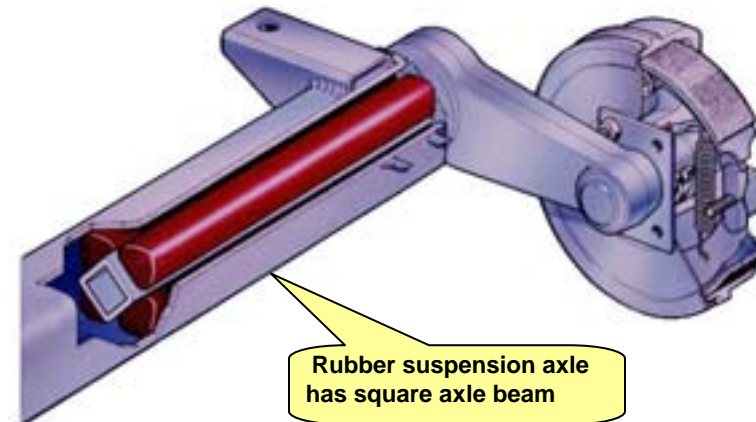

SHOCK ABSORBERS

Shock absorbers are used on all Airstream European specification chassis.

E7 - Tyres

VISUAL CHECK

At the beginning of the season and at regular intervals during it, carefully examine the Airstream tyres to ensure that the sidewalls are sound (no small cracks, cuts, lumps or bulges) and that the tread meets legal requirements.

In the UK, this is 1.6mm minimum tread depth across the central three quarters of the breadth of the tyre tread and around the entire circumference.

Remember that the sidewalls of trailer tyres can easily sustain impact damage on pavement kerbs etc. through trailer cut-in on corners.

As a rule of thumb, tyres are unlikely to last more than 5-7 years with careful use.

Tyre life will be maximized by removing wheels in winter and storing inside and running tyres at correct inflation pressures. If you have any doubt about the suitability of any tyre, it is safest to change it.

TYRE CARE AT END OF SEASON

At the end of the season, place the Airstream on axle stands so its weight does not rest on the tyres.

Better still, remove the wheels completely, store them flat in cool and dry conditions away from sunlight. Removing the wheels also reduces the risk of the Airstream being stolen. If this is not possible, then wheels should at least be rotated every few months to reduce un-even tyre distortion.

TYRE INFLATION PRESSURES

The correct tyre pressure is important both for safety and for a long tyre life. Tyre pressures on the Airstream and towcar must be checked regularly when the tyres are cold, at least once every 2 weeks, but preferably prior to each journey.

A drop in tyre pressure can be caused by:

- the natural leakage of air through the walls of a tyre
- drops in ambient temperature
- small perforations that, in a tubeless tyre, may not lead to immediate deflation but rather deflation over time (a slow leak). This in turn can lead to irreversible damage due to the tyre running in an under inflated condition.

Do not check pressures when the tyres are warm (EG in the middle of a journey), as a misleading reading will be obtained.

To check inflation pressure, purchase a gauge and check tyre pressures each time before you set off.

After checking each tyre, check that the valve is fully tightened and not leaking (applying a smear of saliva over the end of the valve after inflation is a good indicator). Fit a valve cap as protection against harmful grit or dust.

CAUTION! Remember to check the tow car tyre pressures as well. The rear tyres of the tow car must be inflated to the car manufacturer's recommended pressures for towing, please refer to your car handbook or dealer.

The tyres of the Airstream must be inflated to the recommended pressures shown in the table at the end of this Section.

REPLACING TYRES & WHEELS

CAUTION! When replacing tyres or wheels, the replacement wheels & tyres must be of the same type of construction & size as the ones being replaced, to be sure they have the necessary load rating.

Some tyres are reinforced and designed to withstand higher pressure for carrying extra weight (for example 195/70R15 C 104P). The 'C' marking denotes a reinforced tyre. This type of tyre should NOT be replaced with a standard tyre of the same size, without the 'C' marking.

Use only M12 conical wheel bolts supplied by your Airstream dealer.



Spherical bolt



Conical bolt

Conical bolts can be used for both alloy wheels and the steel spare wheel. Tensile strength of wheel bolts varies and the same type should be used as originally specified.

SPARE WHEEL ASSEMBLY

Your Airstream is supplied with a spare wheel assembly, as part of the 'On the Road' pack. This will be fitted to the spare wheel carrier prior to handover.

The spare wheel assembly consists of a steel wheel, fitted with the same tyre as used for the alloy wheels on the Airstream.

The steel spare wheel can be mounted on the wheel hubs using the same conical wheel bolts, used for fitting the alloy wheels.

SPARE WHEEL CARRIER

Check the spare wheel carrier orientation at the time of purchase and consider its suitability for the countries you will be travelling in most often.

The spare wheel carrier pulls out from under the chassis. At the time of manufacture it is fitted so the orientation suits the destination country, to pull out on the kerb side of the road (left side of the road for UK, right side of the road for other European countries).

The carrier may need handing (removing and re-fitting turned through 180 degrees) to pull out on the kerb side, if you travel in countries different from that which the Airstream was originally sold to.



To remove the carrier, take out the security chain pin and unfasten the plastic nut of the spare wheel carrier. Slide the carrier out to its full extent to remove the spare wheel.

JACKING PROCEDURE

To raise the Airstream to change a wheel you **MUST** use a jack.

CAUTION! Never use the corner steadies to lift the Airstream – they are designed for stabilizing, not lifting.

The Airstream is not supplied with a jack, nor axle stand, you need to purchase both as part of your personal Airstream tool kit. **NOTE! The choice of jack is an owner's responsibility.**

Issues to consider are:

- Ensure the jack you purchase has sufficient rating to lift the load it will carry when jacking your Airstream. In reality, you will be lifting approximately half the actual laden weight of the Airstream when lifting one side.
- A trolley jack has wheels and can move with any minor movement of the jacked trailer, whereas a bottle or scissor jack is static.

Portable trolley jacks are available, ensure any jack and axle stand you choose are rated to not less than 2 ton (2000kg).



Always ensure the material beneath the jack is even to provide a firm and sound base.

Always read and follow the jack manufacturer's instructions before using the jack.

E9 – Wheel changing

The following steps should be followed when changing a wheel:

1. Whenever possible, change a wheel when the Airstream is parked on level ground and leave the Airstream hitched to the towcar.

! WARNING: If you suffer a flat tyre on the Airstream and need to change the wheel by the side of the road, especially if the traffic is fast moving, first check the orientation of the spare wheel carrier (see heading 'Spare wheel carrier orientation' above). If you find the carrier is orientated so you would have to pull it out on the roadside, we recommend you call for breakdown assistance, do not risk injury by attempting to remove the spare wheel with cars passing in close proximity.

2. If one of the tyres is flat on a single axle trailer, resulting in insufficient ground clearance to fit the jack, first place a levelling device by the flat tyre and tow the Airstream onto the device to increase clearance.
3. Apply the handbrake on the towcar and the Airstream parking brake.
4. Lower the jockey wheel on the Airstream so it is in contact with the ground and clamp in position. Then the weight of the front of the Airstream will be transferred through both the jockey wheel and to the towcar coupling, when the trailer is jacked.
5. Chock the wheel(s) on the other side of the Airstream securely, with chocks placed to front and rear of the wheel(s).
6. Use a wheel brace, slacken off (but do not remove) the wheel bolts on the wheel to be changed. This should be done whilst the tyre is still in contact with the ground, which will prevent the wheel turning.
7. Jack up the Airstream (see Jacking Procedure) using a jack until the wheel for removal is lifted approximately 75mm/ 3" off the ground. Place an axle stand under the chassis rail just aft of the axle and lower the jack until the axle stand is taking the load.
8. Lower the corner steadies to touch the ground on the same side that the wheel is to be changed. This is an additional stabilizing measure.

! WARNING. Although a jack has to be used to raise one side of the Airstream when changing a wheel, a jack should not be relied upon as the final support. Use an axle stand. Before venturing beneath the Airstream to remove the spare wheel, check the Airstream is adequately supported, in the manner described above.

9. Remove the wheel bolts from the wheel to be changed and remove the wheel itself.
10. If the spare wheel is to be used, take out the security chain pin and unfasten the plastic nut of the spare wheel carrier. Slide the carrier out to its full extent and remove the spare wheel. Check spare wheel for any damage or distortion. Slide the wheel carrier back into position and re-fasten the plastic nut and security chain pin. **NOTE:** The wheel being replaced should not be put onto the spare wheel carrier where it can be forgotten and left in an unrepaired state.
11. Ensure mating surfaces of the wheel hub and wheel and bolt seating areas are as clean and dry as possible. Fit the replacement wheel onto the brake drum and fasten wheel bolts so they are finger tight.
12. Check no persons are under or inside the Airstream. Raise the corner steadies, then raise the jack sufficiently to allow the axle stand to be removed. Then slowly lower the jack fully until the replaced wheel is in contact with the ground.
13. Using a torque wrench, tighten the wheel bolts to the correct torque setting (**85lbs/ 115 Newton metres for alloy wheels and 65lbs/ 88 Newton metres for steel wheels**), following a pattern as represented by the numbers 1-5 below:



15. Check the spare tyre inflation pressure and insert additional air if required to reach the recommend inflation pressure (see Section X).

The torque of the wheel nuts should be re-checked again after approximately 25 miles/ 30 minutes of travel.

USER CHECKS DURING EACH PERIOD OF USE

Check towball is un-damaged, clean and free from grease.

Check friction pad wear indicator to stabiliser coupling.

Inspect underside of coupling head to confirm it is free from dirt and grease. Clean as required.

Apply handbrake and observe brake linkage.

Check breakaway cable for damage.

Check tyre inflation pressures.

Check wheel bolt torque setting after the first run, following a wheel change.

Visual tyre check – inspect tyres for un-even wear, bulges or cracks; particularly after any mishandling – for example if you hit a kerb. Un-noticed tyre damage can cause blowouts.

Be alert to any loose fastenings/ connections, leaking oil etc.

The correction of any defects found during user checks, or use, should be referred to your Airstream dealer, or a BPW after-sales service workshop for prompt service attention.

CAUTION! Inspection, maintenance and adjustment of the brakes, axle(s), hitch and other running gear components should be undertaken only by a trained service technician.

COMMON QUESTIONS

Creaking noise. Creaking noise may occur when driving, common causes are:

- Dirt between friction pads of coupling and towball of car. These noises do not have any effect on the function of the coupling and hitch. First check that the towball is clean.

New towballs may be painted, if so the paint coating should be removed using fine (150 grit) wet and dry paper.

Remove any stubborn deposits with fine (150 grit) wet and dry paper. Then degrease/ wipe clean using a clean rag and aerosol brake cleaner or methylated spirits.

Then check for build up of dirt on the friction pads of the coupling. Remove any deposits with 150 grit wet and dry paper, then wipe clean with aerosol brake cleaner.

- Dry running of drawbar/ draw tube in the bushings of the over run device. Grease the bushings using the grease nipples. Remove rubber gaiter and grease the drawbar.

Heat from wheel hubs

- Wheel hubs will get warm under normal operation. As the brakes are applied to slow down the trailer, they absorb energy, which gets dissipated as heat. Hard braking can result in temperatures being radiated well in excess of 150 Celsius – too hot to touch.

If in doubt, jack each side of the Airstream in turn (see jacking instructions). Check if the wheels spin freely, when the handbrake is off. If the wheels do not spin freely, contact your dealer to arrange for the brakes to be checked and adjusted.

MAINTENANCE

Completion of maintenance work at the prescribed intervals as set out in BPW's maintenance and operating instructions is essential in order to maintain the operating safety and roadworthiness of the Airstream.

CAUTION! Arrange a service at least annually at your Airstream dealer, or a BPW after sales service workshop, so the chassis and running gear can be inspected by a trained service technician.

NOTE: BPW's lubrication and maintenance work schedules (reproduced on the next page) recommend some tasks are done more frequently, according to distance travelled. The intervals being 2000-3000km, 5000km, 10000-12000km.

Lubrication should be done with BPW's synthetic grease (standard grease tends to form waxing when it gets hot).

Parts which will wear and need periodic replacement include:

- Hitch damper. Typical life approx 7 years.
- Friction pads in hitch head
- Brake shoe linings

The frequency of replacement of these parts depends on the intensity of use.

CAUTION! When installing spare parts, it is strongly recommended that only original BPW components are used. Many chassis/ running gear components are safety critical parts. Use of spare parts other than original BPW parts will invalidate the warranty.

E10 – Maintenance

AXLE

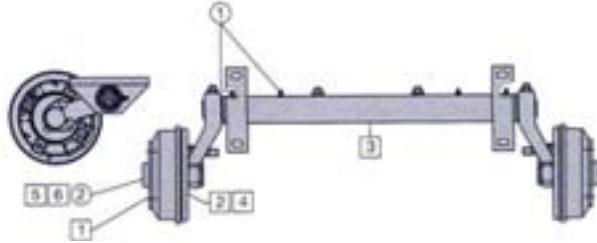

Lubrication and maintenance work For detailed description see pages 12 - 21	after the first run under load conditions	after 500 kilometres	every 2,000 - 3,000 kilometres or annually	every 5,000 kilometres or annually	every 10,000 kilometres or after 2 years
Lubricate					
Maintenance work					
Lubricate					
① In the case of torsion bar axles: lubricate the trailing arm bearing via the grease nipple.			○		
② Change wheel hub bearing grease (does not apply to compact bearings).				○	
Maintenance work					
① Check wheel bolts for firm seating.	<input type="checkbox"/>				
② Check brake play. If necessary, readjust.	<input type="checkbox"/>		<input type="checkbox"/>		
③ Adjustment of the brake system (wheel brake and transmission device)			<input type="checkbox"/>		
④ Check brake lining wear. Check the inner diameter of the brake drum			<input type="checkbox"/>		<input type="checkbox"/>
⑤ Check lateral play of wheel bearing. If necessary, readjust. Compact bearings Conventional bearings		<input type="checkbox"/>	<input type="checkbox"/>		<input type="checkbox"/>
⑥ Check hub caps for firm seating.			<input type="checkbox"/>		
⑦ Check tyres for uneven wear.			<input type="checkbox"/>		
⑦ Check the chassis bolted connection (on caravans)		<input type="checkbox"/>		<input type="checkbox"/>	

HITCH

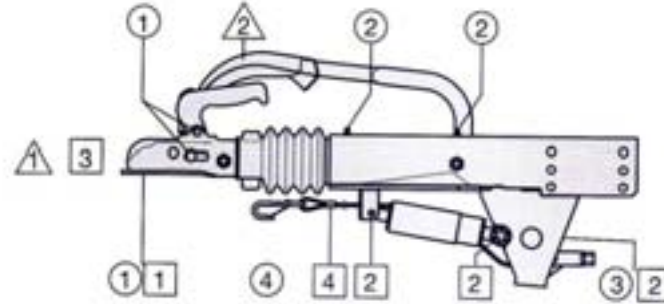

Lubrication and maintenance work For detailed description see pages 9 - 11	prior to each run	Every 10000 - 12000 kilometres or annually
Function test		
⚠ Check coupling.	△	
⚠ Apply the handbrake lever and observe the linkage.	△	
Lubricate		
① Lubricate the coupling head.		○
② Drawbar bearings at the housing of the overrun hitch.		○
③ Oil or grease brake lever.		○
④ Oil or grease moving parts such as bolts and joints.		○
Maintenance work		
① Overrun hitch function check.		<input type="checkbox"/>
② Check drawbar, handbrake lever, spring actuator, reversing lever, linkage and all movable parts for ease of movement.		<input type="checkbox"/>
③ Check permitted vertical play.		<input type="checkbox"/>
④ Check safety cable for damage.		<input type="checkbox"/>

E11 – Components & tyre pressures

Floorplan:	INTERNATIONAL				BAMBI
	<u>532</u>	<u>534 narrow body</u>	<u>534 wide body</u>	<u>684 narrow body & wide body</u>	<u>422</u>
Chassis max load	1700kg	1700kg	1800kg	2700kg	1500kg
Axle used	Rondo DB 1605	Rondo DB 1605	Rondo DB 1805	Rondo DB 2/ 1355	SWING V-TEC CB 1505
Axle type	Torsion bar	Torsion bar	Torsion bar	Torsion bar	Rubber suspension
Axle max load	1700kg	1700kg	1800kg	2 x 1350kg = 2700kg	1500kg
Hitch used	ZAF2,0-2	ZAF2,0-2	ZAF2,0-2	ZAF2,8-2	ZAF1,5-2
Hitch max load	1250 - 2000kg	1250 - 2000kg	1250 - 2000kg	1800 - 2800kg	750 - 1500kg
Hitch vertical max load	150kg	150kg	150kg	150kg	100kg
Safety coupling	WS 3000-D	WS 3000-D	WS 3000-D	WS 3000-D	WS 3000-D
Safety coupling max load	150kg	150kg	150kg	150kg	150kg
Jockey wheel type	02.3712.35.00	02.3712.35.00	02.3712.35.00	05.375.48.05.0	02.3712.35.00
Jockey wheel max load	200kg	200kg	200kg	250kg	200kg
Drawbar type	SDL 20	SDL 20	SDL 20	SDL 28	SDL 16
Drawbar max load	2000kg	2000kg	2000kg	2800kg	1600kg
Drawbar max vertical load	150kg	150kg	150kg	150kg	100kg
Brake used	S2504-7 RASK	S2504-7 RASK	S2504-7 RASK	S2005-7 RASK	S2005-7 RASK
Alloy wheel	Hawk 6.0Jx15, 5/112	Hawk 6.0Jx15, 5/112	Hawk 6.0Jx15, 5/112	Hawk 6.0Jx15, 5/112	Hawk 6.0Jx14, 5/112
Steel wheel	Mefro 6.0Jx15, 5/112	Mefro 6.0Jx15, 5/112	Mefro 6.0Jx15, 5/112	Mefro 6.0Jx15, 5/112	Mefro 6.0Jx14, 5/112
Wheel max load rating	900kg	900kg	900kg	900kg	900kg
Tyre specification	205/65R15 102/100 T	205/65 R15 102/100 T	195/70 R15 104/102 R	185/60 R15 94/92 T	185R14 C 102/100 R
Tyre max load rating	850kg (1700kg for 2)	850kg (1700kg for 2)	900kg (1800kg for 2)	670kg (2680kg for 4)	850kg (1700kg for 2)
Tyre inflation pressures	55psi @ 1700kg	55psi @ 1700kg	65psi @ 1800kg	44psi @ 2200kg 47psi @ 2300kg 51 psi @ 2400kg 52psi @ 2500kg	62spi @ 1500kg



Section F – Electricity



EC325 schematic	F1
EC155 schematic	F2
Normal operation	F3
EC325 Power Control System	F4
EC325 – 12v fuses	F5
EC325 – digital control panel	F6
EC155 Power Control System	F7
EC155 – 12v fuses	F8
230v fuses	F9
Troubleshooting	F10
More information	F11

F1 – EC325 schematic

European specification Airstream International & Safari models:

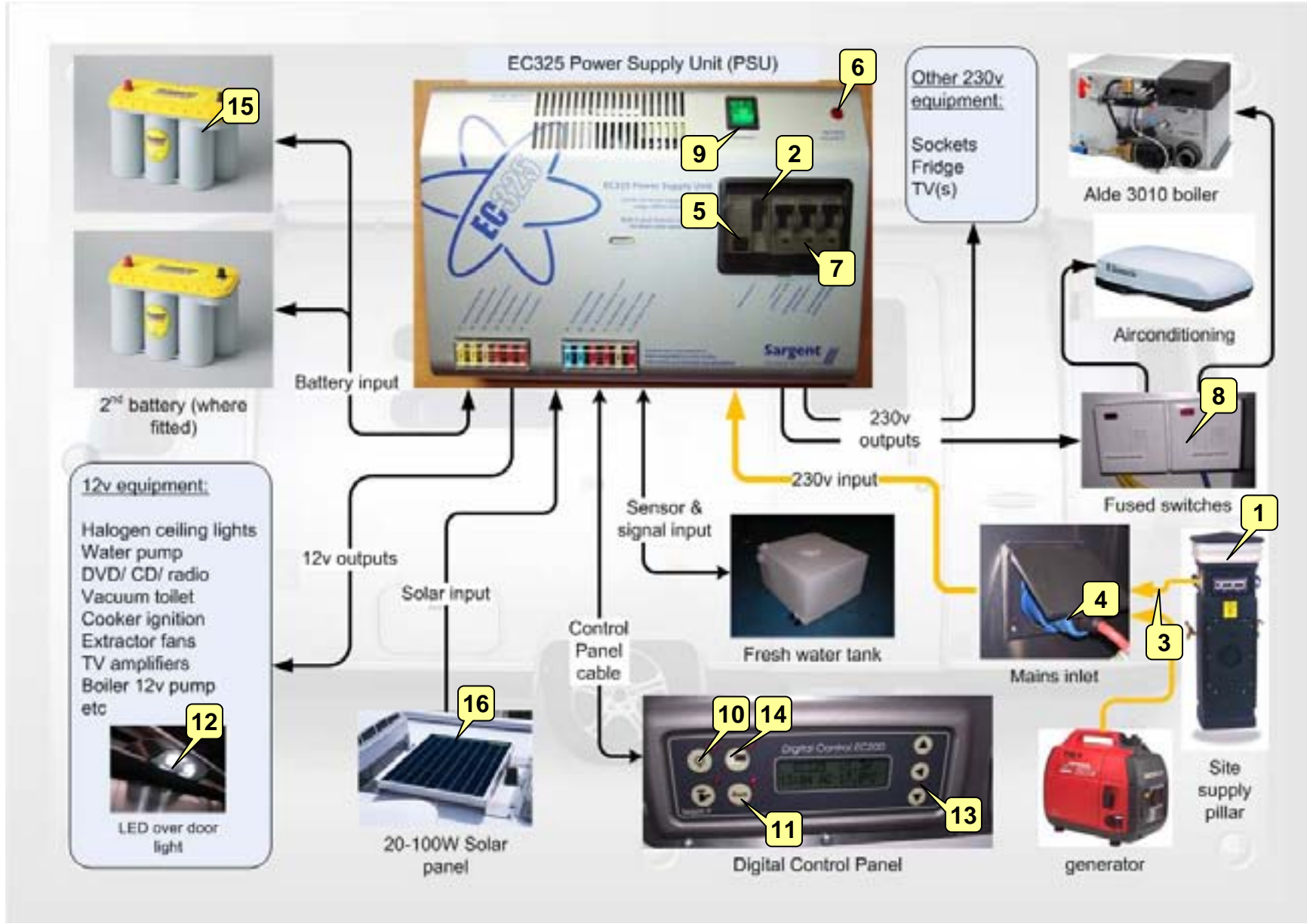

European specification Airstream Bambi model:

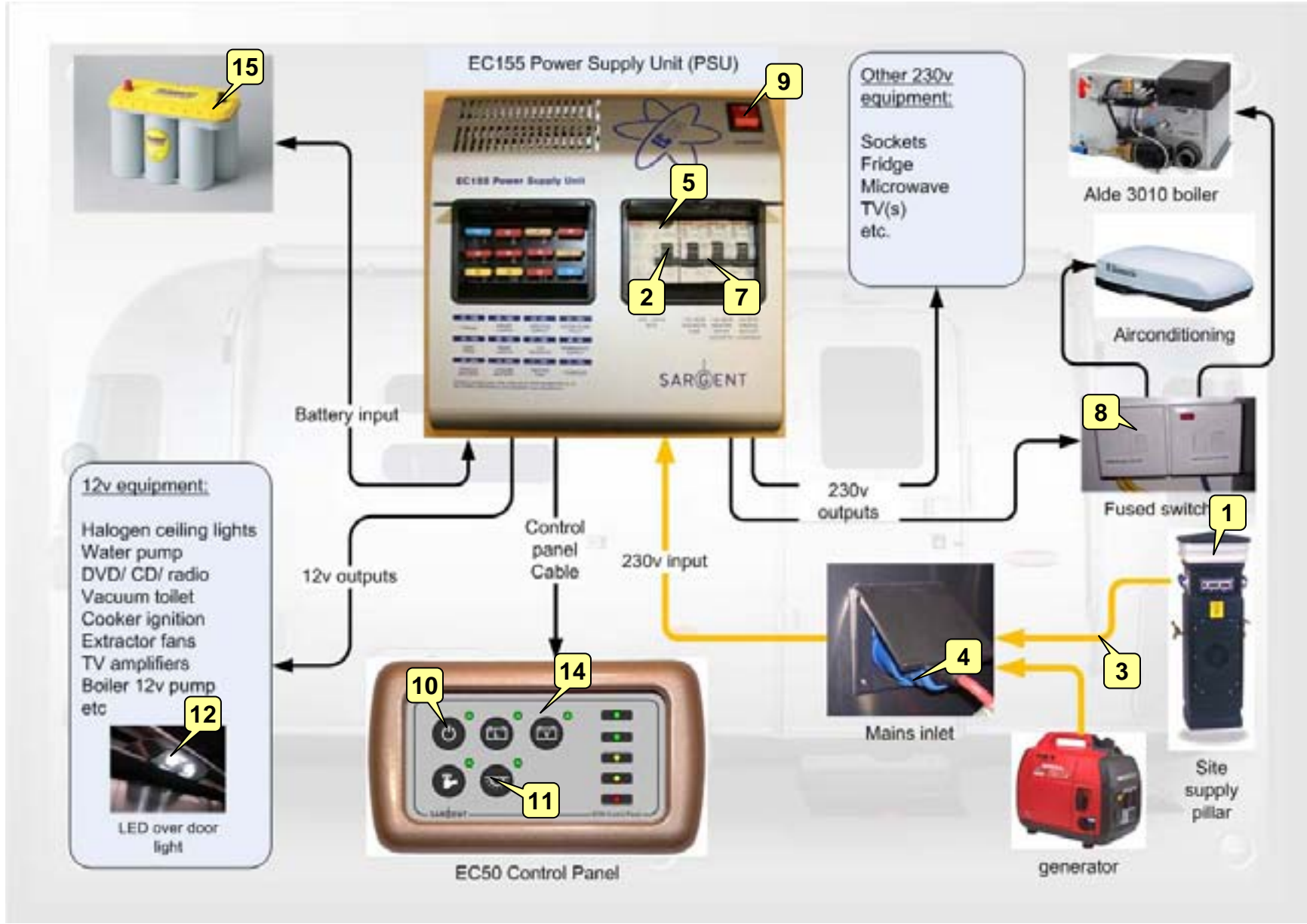

F3 – Electricity, Normal operation

230V MAINS HOOK UP

Plug the orange hook up lead provided into a 230v mains supply, when available (or generator):

- Disconnect towing electric lead between car & Airstream, before connecting to mains supply.
- Inspect site supply pillar **(1)**. Assess if site supply is suitable - whether it is 220-240V AC 50Hz and that it is earthed. Check current available (in amps).
- Turn site supply switch off. Turn off RCD **(2)** on Power Supply Unit (PSU) in Airstream, by setting to down position.
- Unwind orange 230v mains cable **(3)** into loose coils.
- Connect female connector of 230v mains supply cable to Airstream external mains inlet **(4)**. Then connect male end to site supply. Use adaptor if plugging into domestic 230v socket. Turn site supply on.
- Turn on RCD **(2)** by pushing switch up, press test button **(5)**, to confirm RCD trips. Turn on RCD again.
- Check if polarity indicator light **(6)** illuminated (*EC325 only*).
- Turn on 3 x MCB's **(7)** so switches in up position and red indicators displayed.
- Turn on fused switches **(8)** for boiler and aircon, so neon indicators illuminate.
- Turn on charger switch on PSU **(9)** so switch illuminated.

! CAUTION. Unplug 230v mains supply from trailer before using mover device (if fitted).

12V CONTROL PANEL

- Press ON/ OFF button **(10)** on digital control panel (*remote fob available for EC325 – ask your dealer*).
- Adjacent Aux button **(11)** turns on external LED light over entrance door **(12)**.
- Use scroll buttons **(13)** on EC325 to check leisure battery voltage & battery current. Battery current should read zero when charger & control panel both off.
- When 13pin lead is connected to towcar, pressing button with battery symbol **(14)** will toggle between using/ charging/ showing voltage of vehicle (starter) battery on car and leisure battery in Airstream.

! CAUTION. Use vehicle battery in towcar only as temporary measure if necessary, over-use may prevent car starting.

OTHER SWITCHES

Turn on lights using wall switches, or some lights have switches on the fittings.

Ask your dealer to demonstrate:

- Switch above galley controls LED external service light if fitted & waste compartment light.
- Isolation switch for vacuum toilet pump – position varies (outside or inside toilet).
- On/ off switch for tracker motion sensor if fitted, O = OFF, 1 = ON. Switch off before moving the Airstream!
- Inverter on/ off switch (if inverter fitted), supplies TV1 socket only.

12V BATTERY LOCATION(S) AND FUSES

Identify your 12v leisure battery location(s) **(15)**, each has a 20amp battery fuse adjacent.

WARNING! Sealed AGM batteries are supplied, often positioned under beds or seating, do not substitute with normal wet lead acid batteries.

SOLAR PANELS

The EC325 PSU incorporates a solar regulator, suitable for 20W-100W (maximum) solar panel output. Most Airstream International floorplans are pre-wired for an optional roof solar panel **(16)**.

Some models also have a solar panel hook up point, allowing a remote panel positioned on the ground, or your car roof, to be connected.

GENERATORS

Polarity indicator light **(6)** may illuminate when using generator (*EC325 only*).

13PIN SOCKET CONNECTION TO TOWCAR

Fit a 13pin female socket to ISO 11446 to your car matching the 13pin male socket on Airstream, or use an adaptor.

The car alternator can then trickle charge the Airstream leisure battery & power the fridge (12v)

PERIODIC INSPECTION

At least once every 2 years, the Airstream electrical installation should be inspected and tested and a report on its condition obtained. Ask your dealer, or an approved electrical installation contractor.

! CAUTION. Never allow modification of the electrical system except by qualified persons.

F4 – EC325 Power Control System

The EC325 Power Supply Unit (PSU) and EC325 Control Panel are used on European specification Airstream International & Safari models:

EC325 PSU front view:

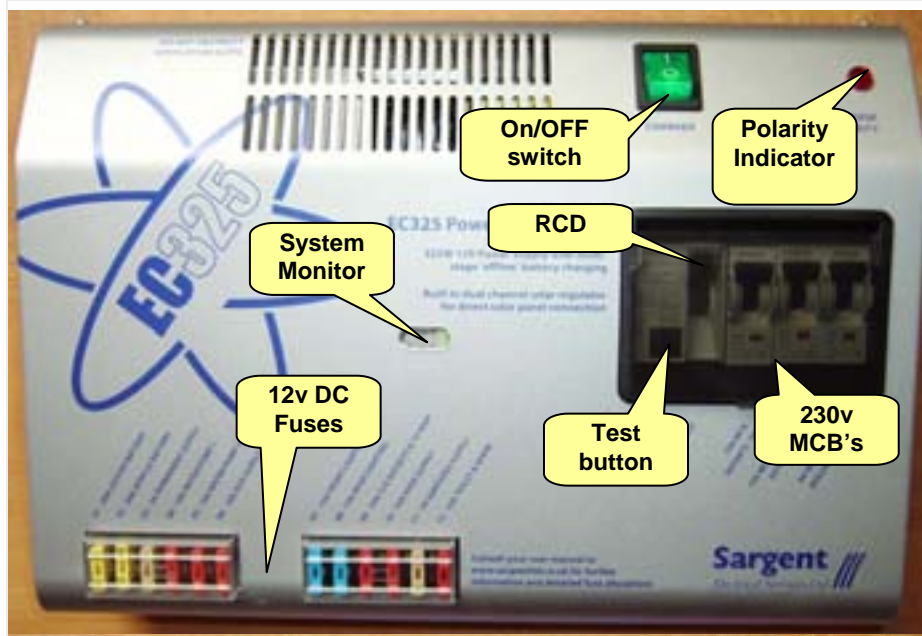

EC325 PSU System Monitor:

Left	Centre	Right	Status	Indication description
-	-	G	Good	Mains supply on, PSU status good.
-	-	-	Good	Mains supply off, PSU status good.
-	O	G	Warning	Mains supply on, PSU in warning mode. In this mode the PSU will limit the output current to protect the unit from damage. It is still safe to use the unit but the fault should be investigated. Typical causes are battery temperature sensor unplugged, cooling fan not working, internal sensors disconnected or failed.
-	O	-	Warning	Mains supply off, PSU in warning mode.
R	O	G	Failure	Mains supply on, PSU in overheat failure mode. In this mode the PSU will shutdown and all equipment will be switched off. The cooling fan will continue to run until the unit cools down. Typical causes are short-circuited DC output, battery connected in reverse, cooling fan failed, cooling vents blocked / covered, problem caused by prolonged use in warning mode.
R	-	G	Failure	Mains supply on, PSU in overheat failure mode.
R	O	-	Failure	Mains supply off, PSU in overheat failure mode.

EC325 PSU bottom view:

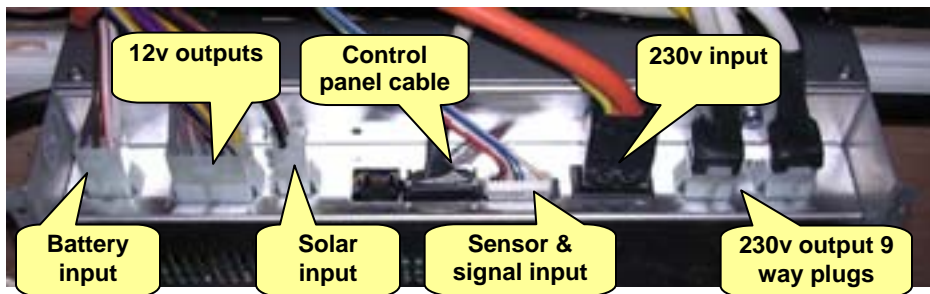

WARNING! Under heavy loads the EC325PSU case may become hot. ALWAYS ensure the ventilation slots and the cooling fan have a clear flow of air. Do not place combustible materials against / adjacent to the EC325PSU. The PSU will shutdown if overheated and will restart automatically when cool.

F5 – EC325 12v fuses

12v DC fuses on EC325 Power Supply Unit:

Fuse No.	EC325 printed fuse description	Rating		Fuse Colour	Wire Colour
1	20A Leisure Battery	20 Amps	Leisure Battery	Yellow	Brown / Blue
2	20A Vehicle Battery	20 Amps	Vehicle Battery	Yellow	Brown / Green
3	5A Permanent Supply	5 Amps	Tracker, fridge electronics, LPG detector (if fitted), reversing camera. <i>NOTE: Alde 3010 boiler can be wired to this circuit by your Airstream dealer if national laws allow the heating to operate whilst driving.</i>	Tan	Brown / Yellow
4	10A Water Pump 1	10 Amps	Water Pump	Red	Purple/ Black
5	10A Water Pump 2	10 Amps	NOT USED!	Red	Not used
6	10A Aux Supply	10 Amps	Porch light	Red	Slate/ red
7	15A Front Lighting	15 Amps	Front Lights, including striped slates, EG Slate/ Red	Blue	Slates
8	15A Rear Lighting	15 Amps	Rear Lights, including striped pinks, EG Pink/ Red	Blue	Pinks
9	10A 12V Sockets & TV Amp	10 Amps	12v Sockets, TV Amplifier, inverter supply, satellite receiver supply	Red	Yellow / White
10	10A Fans Supply	10 Amps	Extractor Fans (Black/ Blue) & Alde 12v circulation pump (Brown/ White)	Red	Black/ Blue, Brown/ White
11	5A Ignitions Supply	5 Amps	Radio (Yellow/ Black) and Cooker ignition (Yellow/ Green)	Tan	Yellow/ Black, Yellow/ Green
12	10A Toilet & Spare	10 Amps	Vacuum Toilet Pump	Red	Purple

Additional 12v fuse(s) located at the Leisure battery(ies):

Battery 1	(Not at PSU)	20 Amps	Battery fuse - fuse remotely located near battery	Yellow	Brown / Blue
Battery 2	(Not at PSU)	20 Amps	Battery fuse - fuse remotely located near battery 2 (where fitted)	Yellow	Brown / Blue

Always carry plenty spare 12v blade fuses of each different rating (5A, 10A, 15A, 20A).

! WARNING When replacing fuses always replace a fuse with the correct value. NEVER replace with a higher value/ rating as this could damage the wiring harness. If a replacement fuse 'blows' do not keep replacing the fuse as you could damage the wiring harness. Please investigate the fault and contact your dealer.

F6– EC325 digital control panel

Display readout here shows:

- model number (EC325)
- software version number (v1.3)
- specification (H)
- current time (12:00)
- Internal temp (23.9°C) in centigrade

The addition of an asterisk (*) in the top left of the display indicates that the alarm is set.

The addition of a hash (#) in the top right of the display indicates that the event timer is set.

The addition of the letters 'AC' in the centre of the display indicates that the AC Mains supply is switched on.

Button	Function
Power ON / OFF	Use to turn the 12v leisure power on and off.
Battery SELECT	Use to select the Leisure or Vehicle battery. Press the button to toggle between the leisure and vehicle batteries. When a battery is selected this battery will be used as the power source and will also be charged by the charger. The adjacent LED is illuminated when the VEHICLE battery is selected; by default when the power is initially turned on the Leisure battery is selected and is indicated by the battery select LED off.
Pump ON/ OFF	Use to turn the water pump power on and off
Aux ON / OFF	Use to turn the LED Porch light over the entrance door on and off.
Scroll UP ▲	Use to scroll the display up (settings section of the menu) or adjust the selected setting
Scroll DOWN ▼	Use to scroll the display down (readings section of the menu) or adjust the selected setting
Select ◀	Use to select a menu item within the settings section

NOTE: See Sargent Electrical Services Ltd additional printed instructions for full technical specs on the EC325 and more detailed breakdown on scroll settings, clock and alarm use etc. The user instructions can be downloaded from Sargent's website: <http://www.sargentltd.co.uk/html/power.html>.

F7 – EC155 Power Control System

The EC155 Power Supply Unit (PSU) and EC50 Control Panel are used on European specification Airstream Sport models:

EC155 PSU front view:

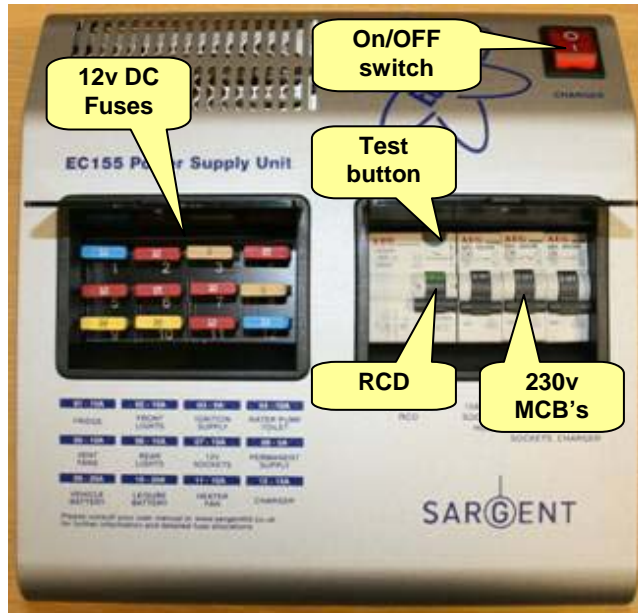

EC50 Control Panel:

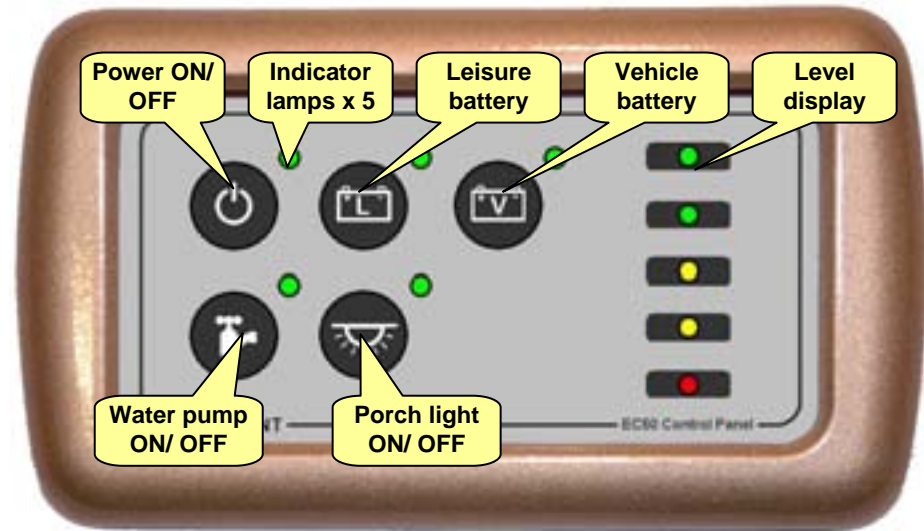

EC50 Control Panel Level display:

LED	Colour	Voltage reading
5	Green	13.5 – 14.4
4	Light Green	12.5 – 13.5
3	Yellow	11.5 – 12.5
2	Orange	10.5 – 11.5
1	Red	<= 10.5

EC50 Operation:

When the Power button is turned on, the Leisure battery is automatically selected and the LED display shows the leisure battery voltage.

Pressing either the Leisure or Vehicle battery buttons, will select and display the voltage of that battery. The Level display will turn off automatically after 5 seconds.

If the Leisure battery drops below 9v an alarm will trigger to warn you that the battery is low. This alarm lasts for 1 minute and then the power will be switched off to protect the battery.

If the Vehicle battery drops below 10.9v an alarm will trigger to warn you that the battery is low. This alarm lasts for 1 minute and then the battery selection will automatically switch over to the Leisure battery to protect the vehicle battery.

NOTE: See Sargent Electrical Services Ltd additional printed instructions for full technical specs on the EC155. The user instructions can be downloaded from Sargent's website: <http://www.sargentltd.co.uk/html/power.html>.

12v DC fuses on EC155 Power Supply Unit:

Fuse	Rating	Fuse Colour	Wire Colour	Description
1	15 Amps	Blue	Red / Yellow	Fridge vehicle feed/ Tracker vehicle feed
2	10 Amps	Red	Grey	Front Lights
3	5 Amps	Tan	Yellow/Green Yellow/Black	Ignition Supplies (eg cooker) Radio supply
4	10 Amps	Red	Purple Purple/ Black	Toilet Water pump
5	10 Amps	Red	Black/Blue	Ventilation Fans
6	10 Amps	Red	Pink	Rear Lights
7	10 Amps	Red	Yellow / White	12v Sockets / TV Amplifier
8	5 Amps	Tan	Brown / Yellow	Permanent Supply (Fridge electronics/ Tracker)
9	20 Amps	Yellow	Brown / Green	Vehicle Battery
10	20 Amps	Yellow	Brown / Blue	Leisure Battery
11	10 Amps	Red	Black/Red	Alde boiler fan
12	15 Amps	Blue	----	Charger

The following table shows details of the fuse(s) located at the Leisure battery:

Battery 1	20 Amps	Yellow	Brown / Blue	Fuse remotely located near battery
-----------	---------	--------	--------------	------------------------------------

Always carry plenty spare 12v blade fuses of each different rating (5A, 10A, 15A, 20A).

! WARNING When replacing fuses always replace a fuse with the correct value. NEVER replace with a higher value/ rating as this could damage the wiring harness. If a replacement fuse 'blows' do not keep replacing the fuse as you could damage the wiring harness. Please investigate the fault and contact your dealer.

F9 – 230v fuses

Residual Current Device (RCD) & Miniature Circuit Breakers (MCB's):

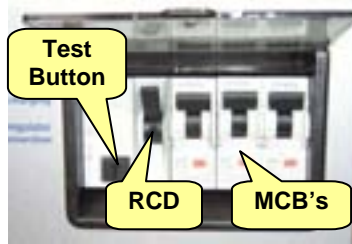

EC325 PSU

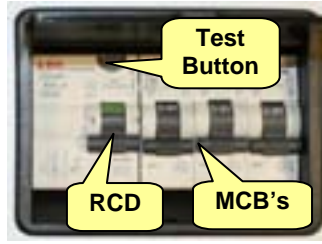

EC155 PSU

The Residual Current Device (RCD) is provided to protect the user from lethal electric shock. The RCD will turn off (trip) if the current flowing in the live conductor does not fully return down the neutral conductor, i.e. some current is passing through a person down to earth or through a faulty appliance.

To ensure the RCD is working correctly, the test button should be operated each time the vehicle is connected to the mains supply (see 230v mains hook up procedure instructions).

The Miniature Circuit Breakers (MCB's) operate in a similar way to traditional fuses and are provided to protect the wiring installation from overload or short circuit. If an overload occurs the MCB will switch off the supply. If this occurs you should investigate the cause of the fault before switching the MCB back on.

The table below shows the rating and circuit allocation for the three MCB's:

MCB	Rating	Description	Wire Colour
1	10 Amps	230v Sockets / Cooker supply	White
2	10 Amps	Boiler/ Air conditioning (if fitted) / Extra 230v Sockets	Yellow (Fused spur assembly, from where yellow cable leads to boiler and blue cable to air conditioner) White for extra 230v sockets
3	6 Amps	Fridge / 12v Charger (internally connected)	Black (Fridge)

12V ELECTRICAL TROUBLESHOOTING

Digital control panel dead (panel shuts down when leisure battery charge drops below 9v):

- Check 20amp fuse adjacent to each leisure battery, replace if blown.
- Check 20amp fuses to PSU - fuse numbers 1 (Leisure Battery) and 2 (Vehicle Battery), replace if blown.
- Follow normal procedure for 230v mains hook up, including turning on green charger switch on PSU, then turn control panel on.

Digital control panel corrupt or erratic function (control panel software crash):

- Remove leisure battery 12v fuse from the PSU, then turn off the PSU on/ off charger switch. This will power down & re-boot the panel.
- Replace leisure battery 12v fuse (ensuring this is not blown), turn on charger, turn on control panel and it should now respond.
- If not, remove the surround to the control panel and unscrew the control panel itself (2 x Philips screws). If there is a 9v battery fixed to the rear of the panel, remove this battery. Then repeat the steps above.

Lights dimming, radio tripping when water pump running, inverter making continuous noise or not working.

- This indicates the leisure battery voltage is low (11v or lower), check leisure battery voltage @ control panel. Turn off some lights and check charger is turned on.

'PSU overheating' displayed on EC325 control panel (indicates 12v DC output exceeding the 25amp maximum for the EC325):

- Check whether system monitor light on PSU is green. If it is orange, the PSU will be limiting the 12v DC output to approx 12amps. Check whether battery thermister correctly connected.
- Remove leisure battery fuse from PSU, turn on charger and monitor whether 'PSU overheating' readout appears. If not, this could point to a short circuited cell in the leisure battery(ies).
- For further troubleshooting, contact your Airstream dealer. They can check the cooling fan is correctly connected inside the PSU.

230V TROUBLESHOOTING

No 230v supply:

- Tripped circuit breakers on campsite supply, as current drawn has exceeded the available supply.
- Orange mains 25m hook up lead not connected, or site supply not turned on.
- Check black plug on orange 230v supply cable into bottom of PSU is pushed in fully and squarely.
- RCD or MCB's on PSU turned OFF.

MCB3 tripping when boiler used with 2 electric immersions, or when fan heating or high wattage appliance plugged into 230v socket:

- Boiler or sockets incorrectly wired to 6amp breaker (rather than 10amp), speak to your dealer.

One or more 230v sockets not working:

- Loose connection on 230v harness, identify which sockets are not working, then speak to your dealer.

ROAD LIGHT TROUBLESHOOTING

Individual road light not working:

- Likely to be blown bulb, remove lens cover and remove bulb to inspect filament and confirm.

Certain circuit not working (EG all left tail lights), possible causes:

- Blown fuse - check 12v fuse on your towcar to the relevant circuit (EG left tail lights). Replace if blown.
- Damaged pin on 13 pin plug on Airstream - examine all pins to check none bent or broken.
- Defective wiring to 13 pin plug on Airstream - take apart and check wires firmly connected into screw terminals, no corrosion or damage.
- Defective wiring to towcar electric socket on car - take apart and check contacts for corrosion, loose wires etc.

No road lights working:

- Loose connection where 13core lead joins main 12v harness inside Airstream – speak to your Airstream dealer

Intermittent flashing to rear LED 6" oval tail lights:

- Bulb failure monitoring system on some high end 4x4 towcars, causes LED trailer lights to flash on and off. Contact your Airstream dealer.

F11 – Electricity, more information

230v ELECTRICITY SUPPLY

The 230v electrical system within the Airstream is designed to run on a 230v 50hz AC supply. The three 230v circuit breakers are rated to 10, 10 & 6 amps, making a total of 26 amps. However the input supply is limited to **16amps** by the connectors used on the mains hook up cable. In addition, if a hook up adapter lead is used, this may reduce the rating further to the rating of the plug used – **13amps** in the UK.

Mains supply

Check when booking into a campsite and on arrival, what the mains supply is to the individual campsite supply pillar. This will be quoted in amps.

This will determine the current you can draw (without tripping circuit breakers on the campsite supply) and may limit the 230v appliances you can use, at least simultaneously.

Whilst modern commercial campgrounds often quote a **16amp** supply, the actual supply available may be lower particularly at peak times in winter months, if the campground is fully occupied and the demand for electricity is high.

Some older campsites may offer only **3-5 amps** to each pitch.

Inspect the electricity bollard to check the type of socket outlet provided. This should be earthed, meaning the plug has 3 pins. Many campsites in Europe are now adopting the European standard for connectors (BS EN 60309-2, formerly 'CEE 17' or BS4343) which is a blue 3 pin connector, rated to 16 amps.

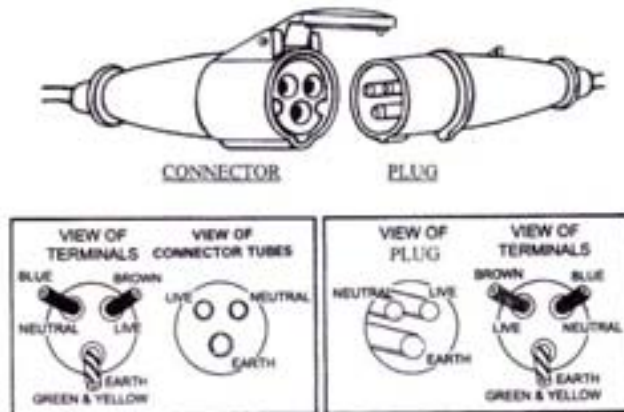

Some continental European campsites still have 2 pin socket outlets, which vary in type. Whilst it is possible to purchase an adaptor (French version illustrated below), be careful to check that the 2 pin plug also has earth strips or sockets, or your installation will not be properly earthed.



! WARNING. If the site does not have a modern EN 60309-2 supply, ask to see the electrical protection for the socket outlet and check with the site operator that it is safe to use. Never use a site without an earthing system.

! WARNING. Always disconnect the towing electrics connector between tow vehicle and Airstream, before connecting a mains supply to the Airstream.

To connect to a 13 amp socket outlet at home, or to a generator with such a socket fitted, you will need a mains hook up adaptor (photo below), these can be purchased from your dealer.



When plugging into the mains supply at home, check the rating of the circuit breaker on the consumer unit, which supplies the socket into which you are plugging the Airstream mains hook up cable.

This needs to be at least **13amps**, the rating of the plug used for the hook up adaptor.

Portable generators

If you are using a 230v AC generator, again the supply in amps will be limited by the output of the generator.

For example the typical portable 2kW generator, such as the Honda EU20 (pictured), has a 2000 watt output, which is equivalent to approx **8.7amps** @ 230v (amps = watts/ volts).



Noise output from generators can be considered a nuisance – speak to any neighbours after letting the generator run for several minutes to warm up, to check that the noise is not intrusive.

Generators vary in quality, cheaper models tend to be noisier and provide less stable power output. Sound output for the Honda EU20i is stated as 59dB at 7 meters with a full load.

Honda pioneered inverter technology; their 'Inverter' generators achieve smooth surge free output (suitable for sensitive electronic products) by generating 12v DC power, which is then passed through an inverter to produce 230v AC.

Two like Honda EU series generators can be linked in parallel to increase available wattage through the generator outlets.

Secure the generator to guard against theft by chaining to a secure object such as a tree, or vehicle chassis.

Generators are heavy, take care where you place this weight and allow for it in your payload calculations.

! WARNING. Generators become hot with use, never leave a generator unattended when young children are at play and take care where siting it – for example long dry grass is a hazard.

! WARNING. Water & electricity are a potentially lethal combination. Do not use a generator in wet weather unless it is covered so the exhaust fumes can escape. Never use a generator in an awning, purchase a generator cover.

Polarity

In the UK, the neutral (blue) wire of mains 230v supply is zero voltage and the live (brown) wire is 230v. To ensure light fittings etc. are not live when switched off, the switch in any appliance socket or switch creates a break in the live wire. The neutral wire remains permanently connected to the fitting. For this reason, it is important that the neutral wire does not become live, a situation referred to as '*reverse polarity*'.

Check for reverse polarity each time you connect to a 230v supply. The EC325 PSU incorporates a 'reverse polarity' warning light, to make this easy.

Reverse polarity can be experienced on a continental campsite, even when the site connector is to EN60309-2. It is possible to rectify the reverse polarity. Your 'on the road' kit includes a reverse polarity lead (photo below), in which the live and neutral wires have been crossed over.



If the reverse polarity light on the PSU illuminates, plug this reverse polarity lead into the mains inlet socket of the Airstream, then plug the 25m hook up cable into this. Then check the polarity warning light again on the PSU.

Or if you are plugging in using a 2 pin continental adaptor, unplug the 2 pin plug, rotate through 180 degrees, plug in again and check the polarity warning light again.

! CAUTION. If these steps do not rectify the reverse polarity situation, disconnect from the mains and consult the site warden for advice.

NOTE: The reverse polarity light will illuminate when using some types of generator, because some generators centre tap the earth connection making both neutral and live conductors 110v above earth. This 110v difference causes the neon polarity indicator to illuminate. In most cases it is still safe to use the generator, but consult the generator handbook for more information.

F11 – Electricity, more information

Inverter

You can obtain 230v AC power by drawing current from the 12v system and converting it to 230v AC using an inverter.

Airstream International models are pre-wired for an optional 150 watt output inverter. This is sufficient for an LCD TV (which draws approx 65watts), or other small appliances like a charger for mobile phone or laptop computer.

The inverter supplies the 230v socket nearest the principal TV. This socket will supply 230v as normal when an external 230v supply is connected. When no external 230v supply is available, turn on the inverter using the wall switch provided. The same 230v socket will then provide inverted 230v power.

NOTE: Inverters are voltage sensitive, if the voltage to the inverter drops below circa 11.9v it will start emitting a low voltage warning.

Another option for watching TV when no mains hook up is available, is to use a TV which can operate off 12vDC.

230v ELECTRICITY DEMAND

Having established the likely supply available in amps into the Airstream, next consider what the demand will be from 230v mains appliances fitted and being used in the Airstream.

The list below shows the output in watts and current consumption in amps for a typical list of 230v appliances which may be fitted or connected:

Appliance	Category of equipment	Amps	Watts
Battery charger (within PSU)	Standard	3 (max)	690
Fridge	Standard	0.8	190
Boiler	Standard	4 or 8 amps	900 or 1800 (1 or 2 immersions)
Aircon	Optional	9.5	2200
Microwave	Optional	6.3	800 output, 1440 input**
TV (LCD type)	Optional	0.3	65
Kettle	Plug in	8.7	2000 *
Fan heater	Plug in	8.7	2000 *
Hairdryer	Plug in	8.7	2000 *

Some of these like the battery charger, boiler and fridge will be standard equipment.

Others like air conditioning, TV's and the microwave are optional equipment.

Lastly you need to consider 230v appliances you may plug into 230v sockets; like a hairdryer, kettle or electric fan heater.

** Domestic portable fan heaters, hair dryers and kettles are each often rated at 2000watts. Lower wattage kettles are available (750watt), they take longer to boil.*

*** The quoted wattage for microwave ovens is the OUTPUT or cooking power. To calculate the approximate INPUT needed, double the output and deduct 10%.*

If you are camping on a site with only a 5 amp supply available:

This equates to 1150 watts (5 x 230v). You will need to monitor and moderate use of 230v appliances so your total wattage being drawn at any one time remains below 1150 watts.

This will be sufficient for battery charging, fridge and TV operation; but you will need to set the boiler to gas only operation and not use any high wattage items like the microwave, air conditioning or plug in hair dryers etc.

Camping on a site without 230v supply

The fridge should be set to gas operation, as well as the boiler.

Without a 230v supply, the battery charger will not operate. You will however be able to operate the 12v systems from the 12v leisure battery.

You will need to moderate use of the halogen lights to reduce the amount of current drawn from the 12v leisure battery and so prolong battery life.

Replacing halogen lights with LED fittings will reduce 12v consumption – speak to your dealer.

12v ELECTRICITY SUPPLY

The Airstream has numerous appliances that use 12v DC power; this includes all lights, water pump, extractor fans, 12v power sockets, TV antenna/ amplifier etc. The 12v Fuse Description Chart earlier in this section lists all the 12v DC fed appliances and the circuit each is fed by.

Power Converter

When a mains 230v supply is connected to the Airstream, a power converter inside the Power Supply Unit in the Airstream powers the 12v leisure equipment (as well as supplying the battery charger).

If you need to use the electrical system without a Leisure battery connected, first remove the 20amp Leisure Battery Fuse from the PSU. This will prevent a short if the ring terminals of the battery terminals touch each other, or the metal lining of a battery box (when fitted). Then turn on the mains 230v RCD, MCB's and the charger ON/ OFF switch on top of the PSU, as normal.

NOTE: The Omnistor electric step on twin axle models will not operate unless a leisure battery is connected.

Leisure battery

The leisure battery on the Airstream is selected by default each time the digital control panel is turned on.

The capacity of a 12v battery is expressed in Amp-hours (Ah).

The typical leisure battery sold by caravan dealers for a standard caravan is a lead acid battery of approx 60amp hour capacity, as it is relatively cheap and small/ lightweight. This type of battery is not maintenance free, must be stored in a compartment vented to the outside and offers limited performance.

Due to the quantity of 12v equipment fitted in the Airstream and the battery position inside the habitable space, a superior quality sealed battery is required. We recommend an AGM (Absorbed Glass Mat) deep cycle battery of the largest amp hour capacity possible.

AGM batteries utilise thick plate technology and fixed electrolyte (rather than fluid acid) contained in micro fibreglass matt. They are considered superior giving more charging cycles, they have longer service life & are maintenance free (do not require re-filling with acid). Being sealed, they do not need to be located in a compartment vented to outside, but a venting tube can be added through the floor.

Larger twin axle European Airstream models may be fitted with 2 x AGM batteries.

All batteries will get warm during normal charging. If you detect excess heat from a battery, speak to your dealer for advice.

! CAUTION. Inspect leisure batteries periodically to ensure the +’ve and –’ve terminals remain covered with the red and black plastic terminal caps, which will prevent any metal objects coming into contact with the terminals. Check the hold down brackets or straps securing the battery to the floor remain firmly fixed down. Ensure the battery fuse holder is accessible.

Vehicle battery

The vehicle battery in the tow car can also be used if the Airstream and tow car are correctly connected electrically. The car power circuit and the earth for it need to be correctly wired through to the Airstream, typically using matching male and female 13pin sockets.

This allows the Airstream to either draw 12v DC power from the vehicle battery in the tow car, or to re-charge it.

! CAUTION. Use vehicle battery in tow car only as a temporary measure if necessary, over-use may prevent the car starting.

Press the battery select button on the digital control panel, to select Vehicle battery. The adjacent LED will illuminate when the vehicle battery is selected. The vehicle battery will then be used as the power source and charged by the charger and/ or solar panels (if fitted to the Airstream).

Use the scroll buttons on the digital control panel to show the vehicle battery voltage. Once the Airstream is connected to the car using the 13pin lead and the vehicle battery has been selected on the digital control panel, the vehicle battery voltage will be displayed, see example below for the EC325:

Vehicle Battery 13.3v (Good)	Voltage reading & battery condition description for the vehicle battery	Less than 10.9 = (Poor) 10.9 to 11.8 = (Fair) 11.9 to 14.4 = (Good)
---------------------------------	---	---

F11 – Electricity, more information

Understanding 12v battery use

Batteries will last longer if not left in a discharged state, or subjected to extreme cold. Hence always take every opportunity to re-charge the battery.

When putting the Airstream into storage, ideally leave the Airstream plugged into the 230v supply, keep the battery charger turned on and the heating set to say 5 degrees to provide freezing protection.

Battery life is typically quoted by the number of cycles at a given depth of discharge (DoD). For example an Optima deep cycle AGM battery should do 1000 cycles at 50% DoD (= approx 12v) and 300 cycles at 100% DoD (< 10.5v). Conclusion – your battery will last 3 times as long if you re-charge it when the voltage drops to say 12v, rather than 10.5v.

Hence, try and avoid discharging the battery below 11-12v. Regularly monitor battery voltage using the digital control panel.

The EC325 control panel allows you to monitor battery current as well, which is useful as it shows whether the battery is being charged, or discharged.

Check the calibration of battery current prior to periods of use:

- Turn the digital control panel OFF & turn the charger OFF on the PSU.
- Temporarily cover any solar panels mounted on the roof.
- Use the scroll buttons to display battery current.
- Press & hold the < Select button until the display says 'calibrating'.
- Repeat (press & hold the select button again) to save the setting.

Then turn on the digital control panel and some lights. The current being drawn by items turned on will now show as a negative reading.

Battery Current -20.2 Amps	Current (in Amps) being drawn from or charged into the selected battery.	Negative figure (-) = current being drawn from the selected battery!
-------------------------------	--	---

This means 20 amps per hour are being drawn from the battery being used. Your battery will be rapidly depleted..! Now turn half the lights off & you will see the current being drawn from the battery reduces to say -10 amps. This shows the effect of moderating use of 12v lights.

Now turn on the battery charger (top button on the PSU). The amount of current the charger can put into the battery is limited by European Regulations to circa 12amps.

As the charger is turned on, the battery current should rise to become a positive figure. This shows current is now flowing into/ charging the battery.

Once you have established positive current flowing in to the battery to re-charge it, scroll to leisure battery voltage and monitor the voltage rising. 14 volts or above represents a fully charged battery.

Some items of equipment are permanently live, being supplied off circuit 3 of the EC325 PSU, or circuit 8 of the EC155 PSU. The permanent live circuit remains live, even when the control panel is turned off. These items of equipment require continuous power and include the tracker, fridge electronics, reversing camera. The boiler can also be wired to this circuit.

The collective current from these 'permanent live' items will discharge the battery when the Airstream is in storage, plus it will naturally 'self discharge' a small % of charge each day, unless some means of trickle charging the battery is provided to compensate.

To prevent over discharge, the EC325 and EC155 systems incorporate a battery protect circuit that warns and then disconnects the batteries when they fall below the following conditions:

Battery	Voltage cut off	Action after cut off	Notes
Leisure	9v	Power is turned off	This is an emergency cut off level to protect the battery from severe damage. You should not rely on this cut off level during normal operation, but manage your power consumption to a discharge level of 10v. This cut off only applies to power drawn from the battery by the leisure equipment that is controlled by the control panel power switch; it will not protect the battery from discharge by permanently connected equipment.
Vehicle	10.9v	Battery selection is changed from Vehicle to Leisure battery. *	This cut off level is designed to protect the vehicle battery from over discharge. The 10.9v level ensures there is sufficient power in the battery to run the vehicle electronics and start the vehicle. This cut off only applies to power drawn from the battery by the leisure equipment; it will not protect the battery if you leave the vehicle lights on.

* If the leisure battery is below 9v then a further warning will occur.

Replacing batteries

Batteries do have a finite life/ number of charge cycles. As they near the end of their life, or if they have deteriorated due to being overly discharged, they will lose charge capacity. Hence an 85Ah battery may only work as a 40Ah one.

Always disconnect the 230v mains supply and turn the PSU charger switch to the OFF (0) position before removing the battery.

! NOTE. If a satellite tracking system is connected, such as a Phantom Tracker, telephone the control centre (for Phantom in the UK: + 44 845 458 0888) before and after disconnecting the 12v leisure battery. You will need to quote the Tracker device number.

A local battery dealer can do a discharge test to determine the remaining charge capacity.

If your Airstream has 2 leisure batteries, both should be renewed at the same time, so the type and their state of charge capacity remains the same.

See previous comments on leisure battery selection under the sub heading 'Leisure battery' earlier in this section.

! WARNING. Do not substitute the AGM batteries supplied with traditional lead acid batteries. You should replace batteries on a like for like basis, but always consult your Airstream dealer when replacing batteries, as newer battery technology may be available.

! WARNING. When connecting the battery, ensure that the correct polarity is observed; black is negative (-) and red is positive (+). Ensure the terminal rings are securely fastened and the plastic caps positioned over the terminals. If the battery is floor mounted, use the fixing clamps/ strap provided and ensure the battery is securely fixed to the floor so it cannot move.

Battery charging

Once a battery state of charge is below 10-10.5v, it will be largely depleted.

The time taken to re-charge depends on the total Ah to be replenished and the rate of charge. For example, if 2 x 75Ah batteries are largely depleted, the total Ah required to replenish is twice 75Ah = 150Ah. At a re-charge rate of 12 amps per hour (the maximum rate of charge of the mains battery charger), the time required would be 150/12 = 12.5 hours approx.

Mains battery charging

The 230v battery charger built into the PSU is the fastest re-charging method. The speed of re-charging varies, according to the output of the PSU fitted.

EC325

The power converter in the EC325 PSU has a maximum output of 325 watts, approximately 25amps at 13.5v DC. This 25amps is split between the 12v leisure equipment and charger, with the leisure load taking priority, as the example below:

Leisure load	Available power for battery charging
10A	15A
15A	10A
20A	5A
25A	0A

So to maximise the rate of battery charging, limit the battery current being drawn by lights and other leisure equipment loads to circa 12amps, i.e. don't turn all the ceiling lights on. This will allow the maximum allowable current (circa 12amps) to be used for battery charging.

The EC325PSU disconnects the leisure battery from the leisure equipment during re-charging. This allows the power converter to supply the maximum allowable 13.5volts for the leisure equipment, but use higher voltages to re-charge the battery.

This results in faster re-charging than previously possible, allows the recovery of heavily discharged batteries and achieves a higher final charge level. It also accurately controls the charging current, reducing the voltage to a trickle as the battery becomes fully charged.

F11 – Electricity, more information

(Mains battery charging – cont)

! CAUTION. Higher voltages may be present at the battery. Do not use any equipment connected directly to the battery when the EC325 charger is operating. Failure to comply with this warning may lead to equipment damage.

! CAUTION EXAMPLE. If a caravan mover device is fitted wired directly to the battery, always disconnect the mains hook up lead from the outside of the Airstream before operating the mover.

The EC325PSU is factory configured for lead acid batteries, which is correct for AGM batteries typically supplied by your Airstream dealer.

The EC325 system incorporates a battery temperature sensor, which monitors the battery ambient temperature to allow the charger to adjust the charging current if the ambient temperature is very cold.

EC155

The EC155 PSU incorporates a fixed voltage battery charger/ power converter. This supplies 13.8v DC, up to a maximum of 12 Amps (155 Watt).

This 12amps is split between the 12v leisure equipment and charger, with the leisure load taking priority, as the example below:

Leisure load	Available power for battery charging
3A	9A
6A	6A
9A	3A
12A	0A

As the leisure load again takes priority, turn off lights and other 12v equipment to increase the available power for battery charging.

Trickle charging using solar panels

The EC325PSU incorporates a dual Solar Regulator. This allows the direct connection of a 20 to 100W solar panel without the need for additional components. The dual regulator charges both the leisure battery and vehicle battery (when connected) simultaneously.

Most Airstream International floorplans are pre-wired for an optional roof mounted solar panel, using a roof harness with plugs into the PSU via a dedicated connector on the base of the PSU.



Some International floorplans also have a solar panel hook up point, allowing a remote panel positioned on the ground, or your car roof, to be connected.

What charging performance can be expected from a solar panel?

Solar panels contribute to charging of the 12v system and help maintain batteries at full charge (trickle charging), but will not recharge deeply discharged batteries in an acceptable time.

The table below shows the maximum possible output in amps for any given size of panel, assuming an output voltage of 13.5v:

30W panel	Divide by 13.5V	= max output of 2.2 amps per hr
55W panel	Divide by 13.5V	= max output of 4 amps per hr
85W panel	Divide by 13.5V	= max output of 6.3 amps per hr

In practice, a panel mounted flat on the roof, rather than at an angle facing the sun at 45degrees, will not be as efficient. Panels work best in sunshine, but still produce some output in overcast and rainy conditions. Rigid conventional solar panels remain the most cost effective.

Battery charging and 12v fridge operation whilst towing

The last leisure battery charging option is charging from the towcar whilst driving, the power being generated by the towcar alternator.

The fridge in the Airstream can also be operated on 12v whilst driving.

The electrical connection between Airstream and towcar must be correct, so all wires of the Airstream 13pin connection lead are connected to the correct wires of the tow car. The best way to do this is to have matching male and female 13pin connectors fitted to both tow car and Airstream. See Section A6 for detailed information on towing electrics and the 3 common types of 13pin plugs found in Europe.

The important pins on the 13pin towing connector for battery charging and 12v fridge operation are:

Pin No.	Function	Airstream harness colour	Airstream 13 core lead colour	Comments
Pin 9	Towcar battery +ve	brown/ green (N/G)	brown/ blue	Supplies current for charging leisure battery, when engine is running
Pin 13	Earth for 9	white/ orange (W/O)	white/ green	
Pin 10	Engine running signal	red/ yellow (R/Y)	brown/ red	Powers fridge +ve (12v operation when driving)
Pin 11	Earth for 10	white/ black (W/B)	white/ blue	

For charging to occur, the engine of the towcar must be running (powering pin 10), then the current for charging flows down pin 9 into the power converter of the PSU.

Similarly, the fridge will only operate on 12v when the engine of the towcar is actually running (key in the ignition is not sufficient), so pin 10 is powered.

The battery charging and 12v fridge operation functions are both checked during manufacture of the Airstream, using a test box with switches to simulate car +ve connection and car ignition.

Once you connect your towcar, you may however wish to reassure yourself that the wiring on your towcar is correctly connected to the wiring on the Airstream, to allow battery charging and fridge operation on 12v when driving. To do this you need a plug in ammeter.

Before connecting the Airstream to your towcar using the 13pin lead, enter the Airstream and switch off the control panel. Remove the leisure battery fuse from the PSU, plug it into the blade holder of the in-line ammeter, then plug the blade of the ammeter back into the leisure battery fuse position of the PSU.

You will see a small current being drawn, now switch on the digital control panel and a couple of lights. Remembering that the ammeter is directional, look to see if you get a positive or negative reading. If you get a positive reading, remove the ammeter and plug it in the other way round. You should now have a negative reading (eg - 2A or whatever current is being drawn, depending upon how many lights are on).

Turn the fridge energy selection dial to 12v operation and the LED indicator should be off.

Now hook up the 13pin lead to the car and start the engine.

The control panel in the Airstream should shut down, the EC325 digital control panel will display 'System disabled Engine started'. On models with electric steps, an auto tracking satellite dish/ solar panel, the step/ dish/ panel should auto retract/ close – if correctly connected to the red/ yellow cable of the Airstream harness.

Whilst someone revs the tow car engine, check the ammeter - you should now have a positive current being shown, confirming that the leisure battery is being charged.

The LED indicator for 12v fridge operation should now be illuminated.

! NOTE. Not all car manufacturers use wiring of a good cross sectional area to carry current from the car battery +ve (which in turn is charged by the car alternator) to the towing plug. Hence it is sensible to have this checked by an auto-electrician (using thicker cable can improve charging).



Section G – Water



Overview – cold water & waste water systems	G1
Normal operation	G2
Equipment	G3
More information	G4
Priming, draining, maintenance	G5
Troubleshooting	G6

G1 – Overview, water system with onboard water tank

European specification Airstream International & Safari models (with onboard fresh water tank):

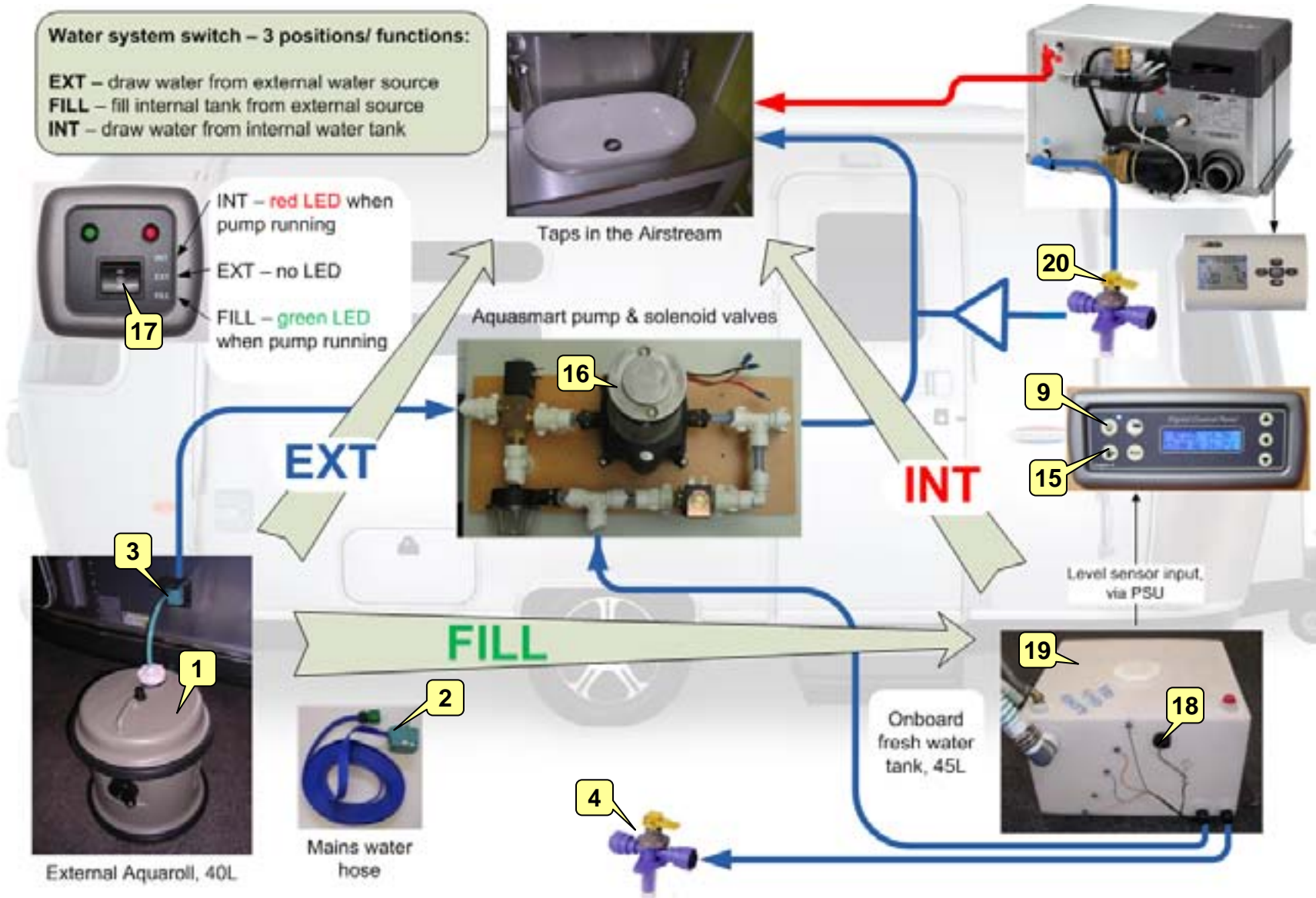

G1 – Overview, water system without onboard water tank

European specification Airstream models without onboard freshwater tank – example Bambi 422:

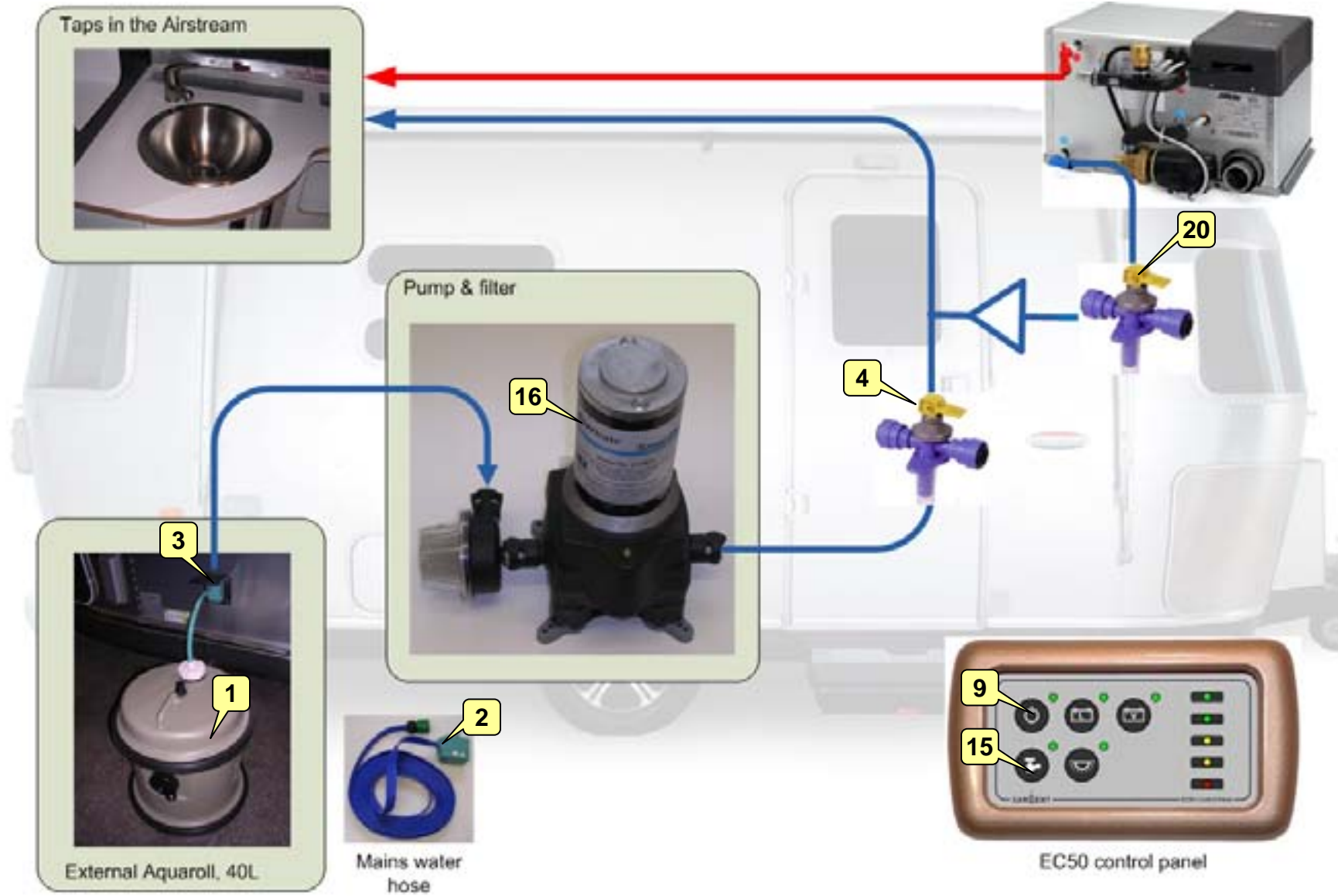

G1 – Overview, waste water system

(Shower tray not shown)

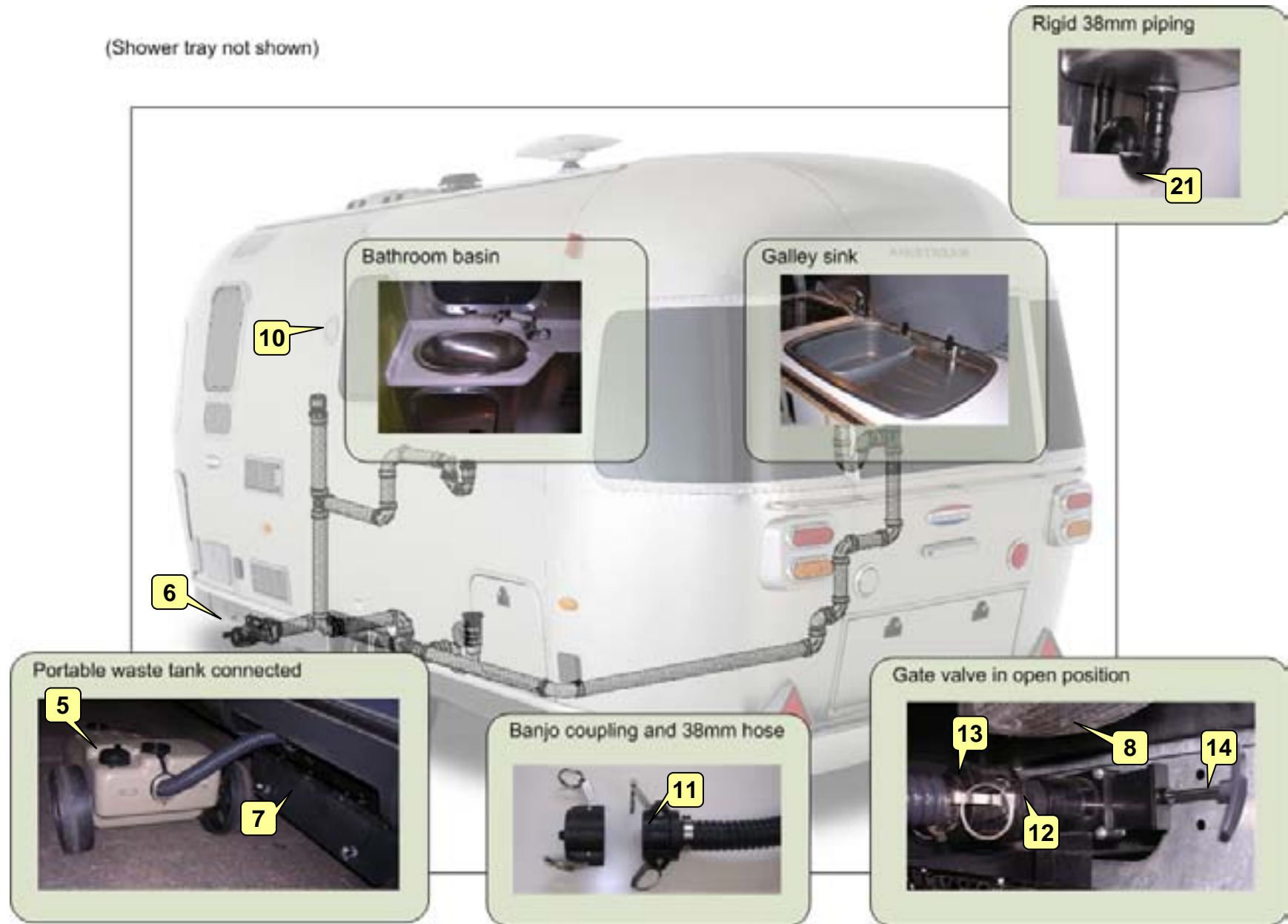

When water system is already filled/ commissioned (i.e. not drained down):

CONNECTING COLD WATER SUPPLY

Fill Aquaroll (1), or other portable water container, from the nearest suitable clean water supply and place next to the water inlet socket of the Airstream.

Alternatively, if a mains water supply is available, un-coil the mains water hose (2) and connect to the tap.

NOTE: Using the mains water connection will provide the best water pressure.

Insert the plug of the water socket & filter (3), or mains water hose into the black water inlet socket on the exterior of the Airstream.

Check that the plug is fully pushed in to the inlet socket, then push down the lid/ cover to the inlet socket (photos below), so the plug of the hose is locked into the inlet socket. Place the filter into the Aquaroll.



Incorrect



Correct

If you are using the mains water hose, now turn the tap ON so the hose becomes pressurised.

If an onboard fresh water tank is fitted, check the yellow handle to the drain down point (4) is in the closed (horizontal) position – adjacent photo (the tank may have been drained down for travel).



CONNECTING WASTE WATER CONTAINER

Place Wastemaster (5) or other portable waste water container adjacent to wastewater compartment (6) of Airstream.

Turn quarter turn catches to open hinged door (7) of wastewater bellypan compartment.

To operate the waste compartment light (8) on International models, the control panel must be turned ON (9), plus the LED external service light (10) must also be on, switched from above the galley sink. The 2 lights are on the same circuit. Then turn the waste compartment light on using the push switch on the fitting.

Fit female banjo coupling of wastewater hose (11) over male coupling (12) of waste water piping in waste water compartment. Pull clips (13) forward to lock coupling.

Pull gate valve handle (14) to out (OPEN) position, so waste water will drain into the Wastemaster, when taps are run inside the Airstream.

Cold water operation

Enter the Airstream.

Turn water pump ON at control panel by pressing button with tap emblem (15) so adjacent LED stays illuminated. The main on/ off switch on the panel (9) must also be turned on.

Models without onboard fresh water tank:

Open the cold tap to either galley or bathroom sink, verify that the water pump (16) turns on and draws water from external water source.

Wait until flow is steady at tap, then turn cold tap off. The water pump should continue to run to build pressure, then shut off. Repeat with hot tap.

Models with onboard fresh water tank:

Use the 3 way water system switch (17) to select which of 3 different functions you wish the pump to perform:



INT – red LED when pump running

EXT – no LED

FILL – green LED when pump running

- **FILL** – bottom position. Select this to fill the onboard water tank (45L) from the external water source. The green LED illuminates when the tank is filling.

The onboard tank incorporates a float switch (18) which will shut off the pump when the onboard tank (19) is full.

Monitor the onboard water tank level using the EC325 control panel, press the scroll buttons until the display reads out the fresh water level.

Once the float switch has activated to stop the pump, move the 3 way switch back to the EXT or INT setting.

- **EXT** – middle position. In this position the pump will draw water from the external water source, when you open taps.
- **INT** – top position. Select this to draw water from the internal tank. The red LED illuminates when the pump is running.

NOTE: If the water pump is turned ON and the water level in the onboard tank is below 25%, a warning beep will sound & the LCD display will flash. To cancel this, press the select (◀) button.

G3 – Water, equipment

PIPING

Water piping is 12mm semi rigid plastic piping (red for hot, blue for cold), connected by 12mm quick connect push fit couplings.



Both white and black fittings are used (**photo above**), which should not be mixed (i.e. a black fitting should not be pushed into a white fitting). Any repairs required should be made with the same piping and fittings.

PUMP & SOLENOID VALVES

The pump used on all models is the Whale Smartflo pressure pump, flow rate 8L/min (2.2 US gallons/min). This is a self priming diaphragm pump with integral pressure switch.

The 3 way switching system used on models with an onboard water tank controls 2 electronic solenoid valves. These 2 way and 3 way valves are mounted on a board, together with the pump and filter (**photo below**), all supplied by Whale pumps.

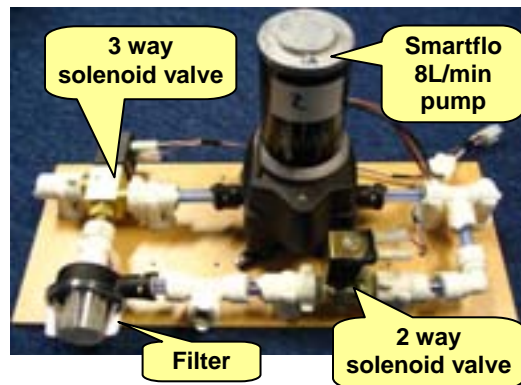

WATER ROUTING

EXT

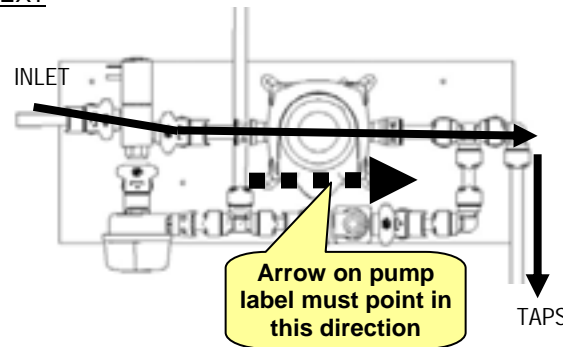

FILL

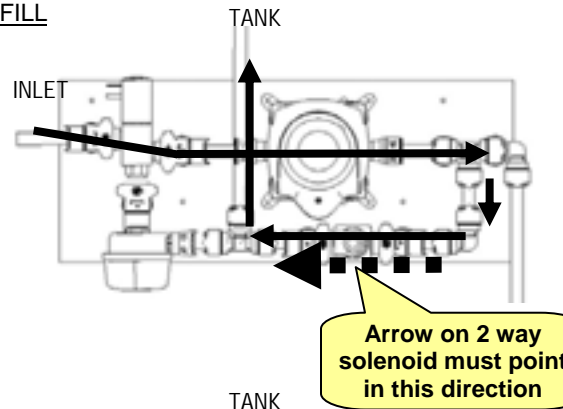

INT

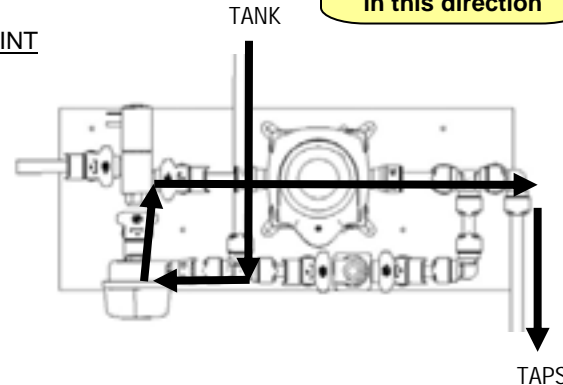

ACCUMULATOR TANK

An accumulator tank (**photo below**) is available as an optional extra, to improve performance.

The accumulator tank maintains pressure in the water system, bringing 2 benefits.

The first benefit is less pump cycling (and therefore less noise). The second benefit is better initial pressure and flow rate when taps are opened.



This accumulator tank can be added at any time, ask your dealer for a quote.

FILTERS

Pump filter

The reciprocating action of pistons in a diaphragm pump are sensitive to small particles of debris.

Hence a filter is always provided to a diaphragm pump. This should be periodically inspected and cleaned. Turn the pump off, remove the cover to the filter (**photo below**), remove the gauze and clear any debris.



Filter on pump/ solenoid board

Solenoid valve filters

The 2 way solenoid contains a small filter (2nd photo below) on the inlet side. This can be inspected if necessary by removing the solenoid from the board.



Inlet socket filter

The water inlet socket on the outside of the Airstream contains another similar small filter. This can be inspected as necessary by removing the inner part of the inlet socket (use manual Philips screwdriver only, or heads of soft stainless steel screws will burr).

The filter is inserted from the rear of the inner part of the inlet socket (right photo below).



Before re-fitting the inner part of the inlet socket, check the O ring is present as highlighted below.



Carbon filter

The hose assembly with plug & filter used to draw water from an external water container has a screw on carbon filter. This should be replaced after filtering 3000 litres (approx 33 days of normal use).

Simply unscrew and fit a new filter. Order spare filters from your dealer, or from the manufacturer: www.whalepumps.com.



ONBOARD WATER TANK

The 45 litre onboard water tank and connections to it are shown below.

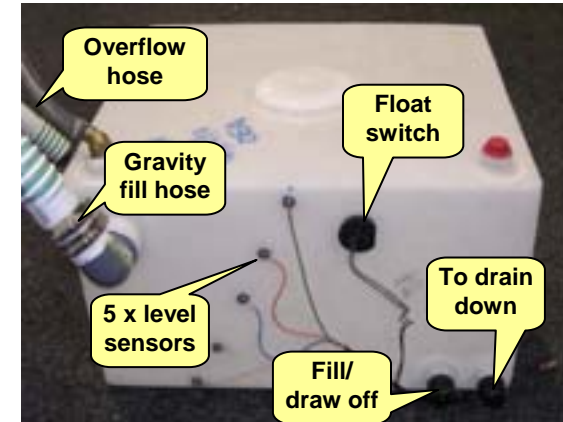

The float switch must be installed so it can rise to the vertical position (photo). The centre of the hole should be min 50mm from the top of the tank.



The level sensors are inserted through 8mm holes drilled in the side of the tank. When the stainless steel screw is tightened, the rubber sleeve expands to seal the hole.



Before installation



Installed

G4 – Water, more information

DRINKING WATER

! CAUTION Any water supply or water system can harbour germs/ bacteria. Whilst sanitising of the water system is possible, we recommend for your own safety that all occupants of the Airstream drink bottled water only.

WATER PRESSURE AND FLOW RATES

Typical flow rate at any tap when drawing water from the external Aquaroll, or onboard tank, will be 3 to 4 litres per minute.

Better flow rate can be obtained by connecting the Aquasource mains water hook up hose to a mains water tap, if one is nearby.

The 3 way switch in the Airstream should be in the EXT - middle position (drawing water from the external source). With the water pump turned 'on' at the main control panel, the flow rate should increase to circa 5 litres/ min.

If the pump is turned off, or there is no electricity, relying on mains water pressure alone would give a flow rate of circa 2 litres per minute.

The Aquasource mains water hose has a pressure inhibitor in the plug, which is set at the factory to regulate pressure at maximum 1.2-1.5bar.

Hence most users will connect to mains water when available, using the mains water hose. This will provide the best pressure and avoid the need to keep filling water tanks.

However in winter months when there is a risk of freezing, use of the mains water hose (which is not insulated) is not recommended. Use the onboard tank, or insulate your external Aquaroll.

! CAUTION When using the Aquasource mains water hose, do not sleep or leave the Airstream unattended without turning off the mains tap.

WATER TEMPERATURE

! CAUTION Hot water temperature can be high from the hot tap, particularly if the boiler is operated on gas and the extra warm water function is selected. Take care to prevent scalding when using taps and showers without thermostatic mixers.

See Section 1 of this Manual for detailed instructions on supply of hot water and heating from the Alde Compact 3010 boiler.

WATER FOR TOILET FLUSHING

Always have the water pump turned on when flushing the vacuum toilet – flushing dry without water risks blockages.

PLUG & FILTER ASSEMBLY

Keep the lid to the water inlet socket in the down (closed) position when not in use, to prevent the entry of insects.

The hose can be pushed into the socket, see photo below, when re-filling your Aquaroll, to prevent the filter coming into contact with the ground.



USING AN ONBOARD WATER TANK

On arrival at your campsite, first select the **FILL** position on the 3 way switch to fill the onboard tank (if fitted). Then re-fill the Aquaroll again and select the **EXT** position to draw water from the Aquaroll. When the Aquaroll is emptied, you can then select the **INT** position to draw water from the inboard tank, without interruption of supply whilst the Aquaroll is re-filled.



INT red LED water pump running

EXT no LED

FILL green LED water pump running

Note: the EC325 water tank level display only shows the level in the onboard tank. To check the level of water in an external Aquaroll, look into the Aquaroll.

Don't forget to empty the portable Wastewater tank. This has similar capacity to the Aquaroll, so will need emptying each time you fill the Aquaroll.

The effect on noseweight of travelling with the onboard water tank full will depend on the position of the onboard tank, which varies – ask your dealer for advice if you are in doubt.

PRIMING AND RE-FILLING SYSTEM

If the Airstream has not been used for several months and particularly if it has not been heated, you may like to ask your dealer to re-commission the system. They can do an air pressure test before re-filling with water.

Fill Aquaroll and connect to Airstream using socket & filter, or connect mains water hose and turn tap on.

Close both drain down points – cold water tank drain down (4) near to onboard water tank and hot water drain down adjacent to boiler (20). Yellow handle should be in horizontal position.

Check and close hot & cold taps to all sinks, internal shower and external shower.

Lift seat cushions to give visible views of the pump, so you can hear it running and quickly see any leaks.

Select EXT position on 3 way water system switch (17).

Press on/ off button (9) to turn on control panel and then turn on water pump (15).

Open hot tap furthest from boiler and leave tap open to release air from the boiler hot tank reservoir, as it fills with cold water. When water flows steadily from the hot tap, switch the same tap to cold to bleed air from the cold water pipework and wait until water flows steadily. Then turn the tap off. The pump will continue running to build pressure, then shut off.

Then the system is filled and ready to use. Proceed to fill the onboard water tank as normal (see previous section “cold water operation”).

DRAINING DOWN

For full instructions on winterising your Airstream, see section D5 of this Manual. The text below deals with the water system only.

Turn off the water pump (15) at the control panel.

Open all taps until no water flow. In the case of single lever taps, move the tap to midway between hot and cold and lift to the open position, then leave tap in open position.

Open all showers to ‘on’ position. Un-clip shower heads to internal and external showers (including pull out shower heads to wet baths, which should be pulled out fully). Depress any hand spray levers while holding down into the shower tray/ onto the ground, until there is no further water flow.

Depress the WC foot pedal.

Open cold water drain down point – lift yellow lever of cold water tank drain down, usually positioned near to onboard water tank (if fitted).

Drain the domestic hot water tank in the Alde boiler. Lift the yellow lever to the drain down point, which is usually positioned close to the Alde boiler.

Select FILL position on 3 way water switch (17).

Press on/ off button to turn on electronic control panel and then turn on the water pump (15).

Leave for 30 seconds, then turn 3 way switch to EXT position and leave for another 30 seconds.

Access the waste water bellypan compartment. Pull gate valve and leave in fully out (open) position, to drain any water from waste water piping.

CAUTION! If water is allowed to freeze in the system, serious damage to the water heater, pipework and pump will occur.

MAINTENANCE RECOMMENDATIONS

O rings on male spigot of water inlet socket

- Check periodically that both O rings (there are 2) on the male spigot of the mains water inlet are present and undamaged.



Renew carbon filter

- Renew screw on carbon filter to plug & filter hose assembly, after filtering 3000 litres (approx 33 days of normal use).

Accumulator tank pressure

- If an accumulator tank is fitted, check the pressure periodically using a tyre pressure gauge. Add additional air as required using manual or electric tyre pump, to maintain the recommended operating pressure of 19-20 psi.

Pump head replacement

- Replace water pump head every 5 years. Return water pump to your dealer to have service kit fitted.

G6 - Water, priming/ draining/ maintenance

Pump not working:

- Pump not turned on at control panel **(15)**
- Turn on tap to activate pressure switch in system.
- Check 10 amp blade fuse serving the water pump, replace if blown.
- Check wiring to pump and solenoids is as per the table below:

Colour	Connected to:
Purple/Green	Pump white wire
Purple/Black	Pump red wire
White/Orange	Pump black wire
Purple/Orange	3 way solenoid
White/Orange	3 way solenoid
Purple/White	2 way solenoid
White/Orange	2 way solenoid

Pump not turning off:

- The usual cause for the pump not being able to build pressure and turn off is the cold water supply has run out – check Aquaroll or internal water tank and fill if empty.
- If tanks are sufficiently full, check for taps left on, or leaks in the system.

Pump not priming:

- Check that plug of hose is fully engaged in the inlet socket, with cover to the inlet socket correctly pushed down to lock the plug of the water hose in the inlet socket.

Pump clicking on periodically:

- Any slight drop in pressure in the water system will often cause a pump to cycle on and off for a few strokes. This can be irritating, especially at night.

Check that all taps are turned off and none are dripping water. Check for signs of leakage elsewhere - adjacent to the pump, on the floor, or under the Airstream.

If no leaks can be found from the cold & hot water piping, check and clean the filter adjacent to the pump.

If the pump cycling continues and becomes regular, despite a check for leaks and cleaning of the filter, speak to your dealer. The pump may need disassembling and cleaning.

In addition, an accumulator tank could be added which will maintain pressure in the system once fitted and prevent cycling of the pump.

In the meantime, the pump can be turned off at the control panel **(15)** to prevent it cycling, for example at night, when taps or the WC are not being used.

Water dripping externally out of water inlet socket:

- Likely cause is debris partially blocking either the pump, or the 3 way solenoid valve. Contact your dealer.

Pump not shutting off when filling onboard tank:

- Check float switch. Drain down onboard tank by opening drain down, until water level is below the float switch. Remove the float switch by pulling it out of the tank wall. Clean if necessary.

With pump turned on and 3 way switch set to FILL, lift float manually to verify if pump shuts off. Re-fit float switch by removing outer rubber seal, installing this in tank side wall first, then push float switch into this.

Leaks from water pipe connections:

- If the system is not drained down and allowed to freeze in winter, freeze/ thaw action can cause the semi rigid pipes to partially push out of the push fit couplings, causing leaks when the system is put back into service.

Access all connections and check the semi rigid piping is fully pushed into the push fit couplings.

Low flow:

- Check carbon filter is suspended correctly in the Aquaroll and is not suspended upside down
- Check 3 way switch is in the EXT or INT position, it should not be in the FILL position other than when filling the internal tank
- Filters clogged and need clearing

Section H – Gas



Overview

Normal operation

Further information

Facts & maintenance

Troubleshooting

H1

H2

H3

H4

H5

H1 – Gas, Overview

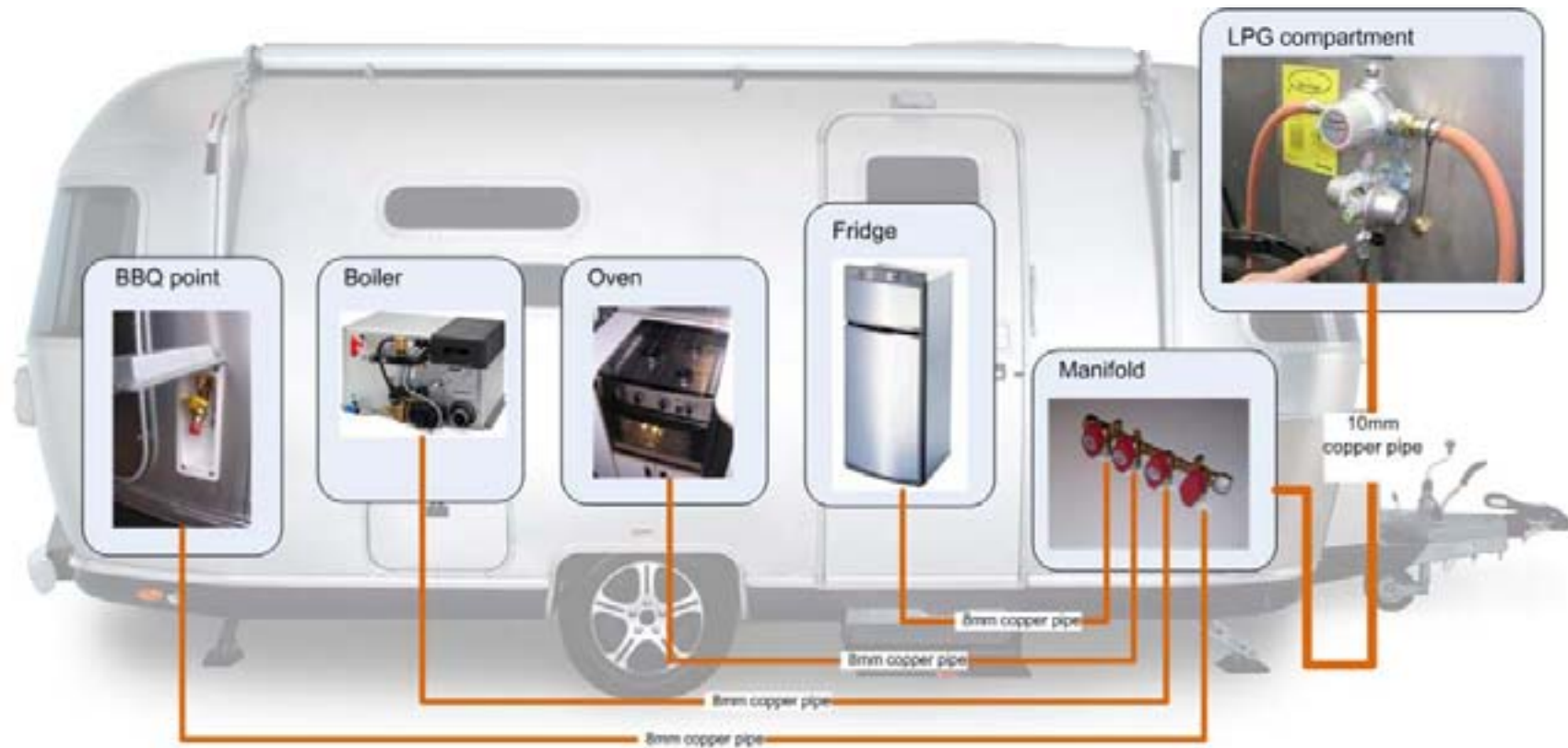

Equipment may vary (not all units have a BBQ point), positions are illustrative only, not to scale.

LPG COMPARTMENT

Remove the cover to the separate LPG (liquid petroleum gas) compartment (1) externally on the drawbar to the front of the Airstream:

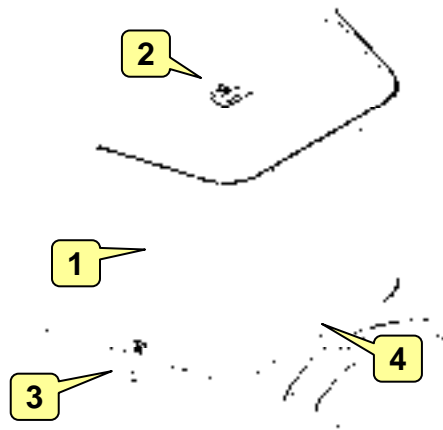

To remove the LPG cover, unlock & turn the latch on the top of the cover (2), then loosen the bungee cords (3) holding the cover to each side of the drawbar.

Then lift the cover up, tilt it forwards and lift it off.

Before re-fitting the cover, it helps to have the winder handle of the jockey wheel facing forwards.

To re-fit the LPG cover, offer the cover up tilted forwards, so the front of the LP cover fits over the L bracket (4) fixed to the drawbar cover. Then push the cover down and into place over the vertical backrest which the regulator is fixed to.

Secure the cover by turning and locking the latch (2), then fix the bungee cords – if present – to the hooks on each side of the LPG cover.

! WARNING. Always check that the LPG cover is secured, with the latch turned and locked and the bungee cords fixed before travel.

LPG CYLINDERS

Check gas level in cylinders. Some cylinders have inbuilt level gauges, or transparent walls (BP Gaslight) revealing the liquid level, or lift the bottle.

Turn off all gas operated equipment inside the Airstream before opening cylinder valves.

Open valves on both gas cylinders:

BP Gaslight cylinders have an adaptor (5) which needs to be pushed down onto the top of the cylinder. Then turn the black switch (6) a quarter turn from the horizontal, to the vertical position.



AUTO-CHANGEOVER

Use the control knob (7) on the Duo-comfort automatic changeover to manually select which cylinder will be operating and which will be held in reserve.

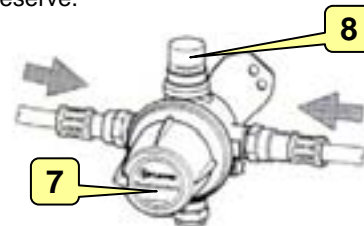

The mica window (8) indicates the status of the cylinder that is being used/ selected: green = full, red = empty. The valve will automatically switch over when the pressure in the operating cylinder falls below 0.5bar.

REGULATOR

The regulator is mounted below the auto-changeover, this regulates the gas pressure to a uniform 30mbar with flow rate of 1.2kg/hr.

If a Truma SecuMotion regulator is fitted, this also monitors the pressure. An integrated gas flow monitor will shut off the flow of gas if the pressure falls below 27mbar (due to gas pipe break for example).

After opening the cylinder valves, slowly press the green reset button (9) on the Secumotion regulator, then release slowly (3 seconds).

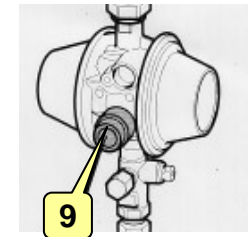

If no pressure point is felt when the button is pressed again, the regulator is ready for operation (repeat procedure if necessary).

MANIFOLD

The manifold valve (10) is located inside the Airstream, its position varies, ask your dealer.

The supply to each gas appliance can be turned on or off independently by turning the red tap knobs; vertical = open, horizontal = closed.

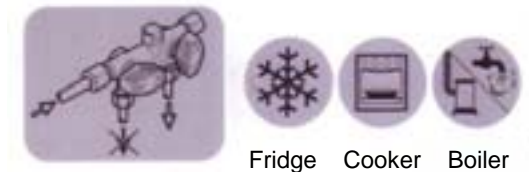

When a BBQ point is fitted (check externally) to the Airstream, there will be a manifold with 4 (rather than 3) taps. The 4th tap serving the BBQ point will be the tap without a label fitted.

H3 – Gas, further information

LPG GAS TYPES

The European Airstream gas installation is designed to operate on either propane or butane LPG at 30mbar.

Butane has a higher calorific value, but it will not change from liquid to gas below 0 degrees centigrade at atmospheric pressure. It is not therefore suitable for winter use.

As the need for heating is greater in winter months, propane is generally the customer's preferred fuel.

CYLINDER TYPES AND SIZES

The Airstream's LPG compartment can accommodate cylinders up to 7kg in size. Cylinders can be exchangeable or refillable type.

Noseweight will increase as the cylinder size increases, but this can be mitigated by using cylinders of lighter weight construction.

Cylinder options will vary in different EU countries. Examples of cylinders available in the UK:

5kg BP Gaslight - Because the 5kg BP Gaslight propane cylinder is shorter, a rubber hose can be used as it slopes downwards to the cylinder head. This is necessary so that plasticisers in the rubber do not get into the regulator.

6kg Calorlite – The 6kg Calor lightweight propane cylinder launched in 2008 is taller and whilst it can be accommodated in the Airstream LPG compartment, the hose will be nearly horizontal to the cylinder head. It is recommended that this cylinder be used with stainless steel hoses.

6kg Gaslow refillable cylinders – These are steel & therefore heavier. The advantage is they can be filled at an Autogas service station. Autogas in the UK is propane, on the continent a small amount of butane is added. A Gaslow installation requires a filling kit to be fitted to the Airstream.

CYLINDER RESTRAINT

Cylinders should be secured in the LPG compartment using the straps provided (2 straps per cylinder). The straps are vertically spaced to suit 5-7kg cylinders.

The use of larger cylinders sited outside the LPG compartment is not recommended. If you choose to do this, the connecting high pressure hose should not exceed 750mm.

! WARNING If using cylinders other than those recommended, ensure these are adequately supported and do not cause damage to other fixtures and fittings located in the compartment.

HIGH PRESSURE HOSES

Use only approved high pressure hoses to connect the gas cylinders to the auto changeover.

The type of thread used for high pressure hoses varies in different EU countries, consult your local dealer.

High pressure hoses sold are rubber (last 5 years), or stainless steel (last 20 years).

If hoses are left not connected to a cylinder for any extended period, the open end should be protected against the entry of dirt or insects.

NOTE: Customers using Truma rubber hoses connected to BP Gaslight cylinders containing propane, will note the rubber hose is marked 'butane only'. This is because the thread of the butane hose is correct for the adapters that fit the BP Gaslight bottles.

This is not cause for concern. Truma butane and propane rubber hoses are identical being manufactured using the same material, the only difference is the threaded connection at the cylinder valve end – male left hand thread for butane, female left hand thread for propane.

BBQ POINT

Your Airstream may be fitted with an external gas BBQ point. This is for use with a gas barbecue only.

Lift up the flap to the BBQ inlet, unplug the red plastic cap and connect the BBQ in accordance with the BBQ manufacturer's instructions.



To connect the BBQ, you will require a male spigot that fits into the female fitting of the BBQ point. Ask your dealer.

The BBQ point has an integral isolation valve, which will only open when a pipe has been connected. Do not apply force to this valve.

! WARNING If a gas BBQ point is fitted externally, always position the BBQ in the open air. Do not use a gas BBQ under or in an awning.

FACTS ABOUT LPG

LPG is not poisonous. Bi-products are harmless.

LPG has been given a smell by the manufacturers in order to identify leaks. LPG is heavier than air and therefore sinks to the lowest point.

There is a danger if all air and oxygen are excluded. Gas drop holes & low level ventilation holes must be kept clear at all times.

VENTILATION

The high and low level ventilation provided in the Airstream complies with BSEN 721.

Vents should not be obstructed in any manner, as this could lead to insufficient fresh air. In this case the confined atmosphere becomes depleted of oxygen which leads to the formulation of the highly poisonous gas 'carbon monoxide'. Carbon Monoxide is odourless, colourless and tasteless and will rapidly cause unconsciousness and death with little or no warning prior to collapse. **THERE IS NO DANGER WHEN ADEQUATE VENTILATION IS PROVIDED.**

! CAUTION Regularly check that the low level vents through the floor are unobstructed.

These vents consist of gas drop holes (11) near/ under gas appliances, plus 2 x 200sqcm vents under the convectors to the front of the Airstream. These are ducted above floor so they cannot be obstructed, but check the plastic covers (12) below floor to confirm they are clear and free from dust.

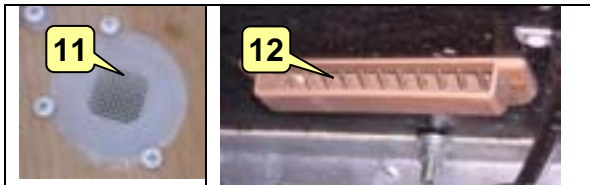

SUSPECTED GAS LEAKS

If you smell gas or suspect a leak and it is safe to do so, turn off the gas appliances and turn off the valves on the cylinders. Evacuate the Airstream and ventilate the interior. See professional advice as to the cause of the leak.

! WARNING Never use a naked flame to check an appliance for leaks.

A gas engineer with experience of LPG installations should confirm & correct the source of the leak and check the system is sound before it is re-used.

GAS APPLIANCES

Ensure you have read the operating instructions for each gas appliance, as supplied by the appliance manufacturer, contained in your Owner's Pack.

Turn off gas appliances before travel, except those heating appliances (such as the Alde 3010 boiler) designed to function when the vehicle is in motion.

! WARNING Do not use appliances with a different working pressure to 30mbar.

! WARNING Do not use independent portable gas appliances inside the Airstream.

! WARNING Do not misuse appliances, for example do not use cookers as heaters.

! WARNING Maintain adequate spacing of combustible materials from sources of heat.

MAINTENANCE

Regularly check flexible gas hose joints and connections for tightness.

Inspect flexible high pressure hoses regularly for deterioration and renew, as necessary, with approved type, in any case no later than the expiration date marked on the hoses.

Check the gasket/ O rings (13) are present to both ends of the gas hoses each time the hoses are re-connected.

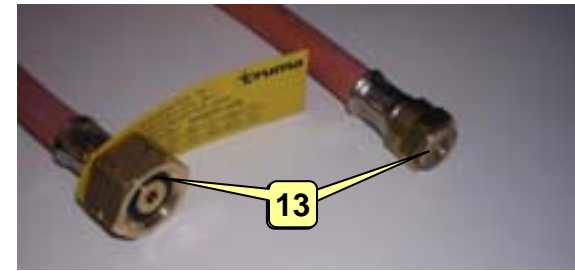

Use of a leak finder spray on these high pressure hose joints is recommended to check for leaks after each cylinder or hose replacement.

Annual service.

A gas engineer with experience of LPG installations should check your Airstream gas supply system once a year and issue a dated certificate verifying its integrity.

This should include an air soundness test of the piping to 150mbar and check of gas appliances in accordance with the manufacturer's instructions.

H5 – Gas, troubleshooting

No gas flow

- Check there is liquid gas in one or both LP cylinders.
- Open valve on cylinder to be used.
- Turn auto changeover control knob towards the cylinder to be used.
- If the regulator incorporates a green reset button (**left photo below**) slowly press this, then release slowly (3 seconds).



Green reset button



Yellow knob

- If the regulator has a yellow tap fitted, turn this so it points vertically down (**right photo above**).
- Check that the red tap knobs to the internal manifold are in the open (vertical) position.
- Turn on and attempt to ignite the gas supply to one of the cooker gas rings, to confirm that gas is flowing

Fridge not lighting on gas operation.

The fridge orange LED indicator light for gas operation flashes yellow intermittently. This usually indicates air needs purging from the gas pipe to the fridge, following changing a gas cylinder.

Turn the fridge off by turning the energy selector dial to the top position (**A**).

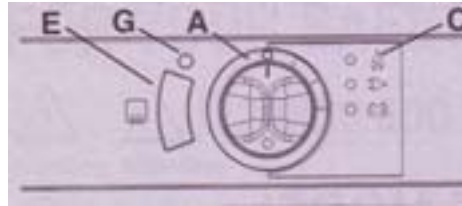

Check gas supply. Try lighting one of the cooker gas rings, if they also will not light then investigate at the LPG compartment. Check the gas cylinder valves are turned on, one or more cylinders have gas inside, the regulator test button has been pressed. Then check that the manifold tap serving the fridge is in the open (vertical) position.

Then turn the fridge energy selector switch to gas operation again. The fridge will attempt to ignite again. Repeat the procedure of turning off, then to gas operation 3-4 times, to remove air from the gas pipe. If after this the fridge will still not ignite on gas, consult your dealer.

'Gas out' displayed on Alde boiler control panel.

Similar to the fridge.

First using the Alde control panel, set gas operation to OFF - see top of page 23 of Alde operating instructions. Then check the gas supply – see paragraph above. Then set the Alde control panel gas operation to on.

Repeat this procedure 3-4 times as necessary to purge air from the gas line. Once the boiler ignites on gas, you will feel heat coming from the wall flue externally.

Section I – Heating & hot water



Overview – system layout	I1
Boiler	I2
Control panels	I3
Normal operation	I4
Circulation pumps & bleeding	I5
Maintenance	I6
Troubleshooting	I7

I1 – Heating overview – system layout

Typical European specification Airstream heating system layout:

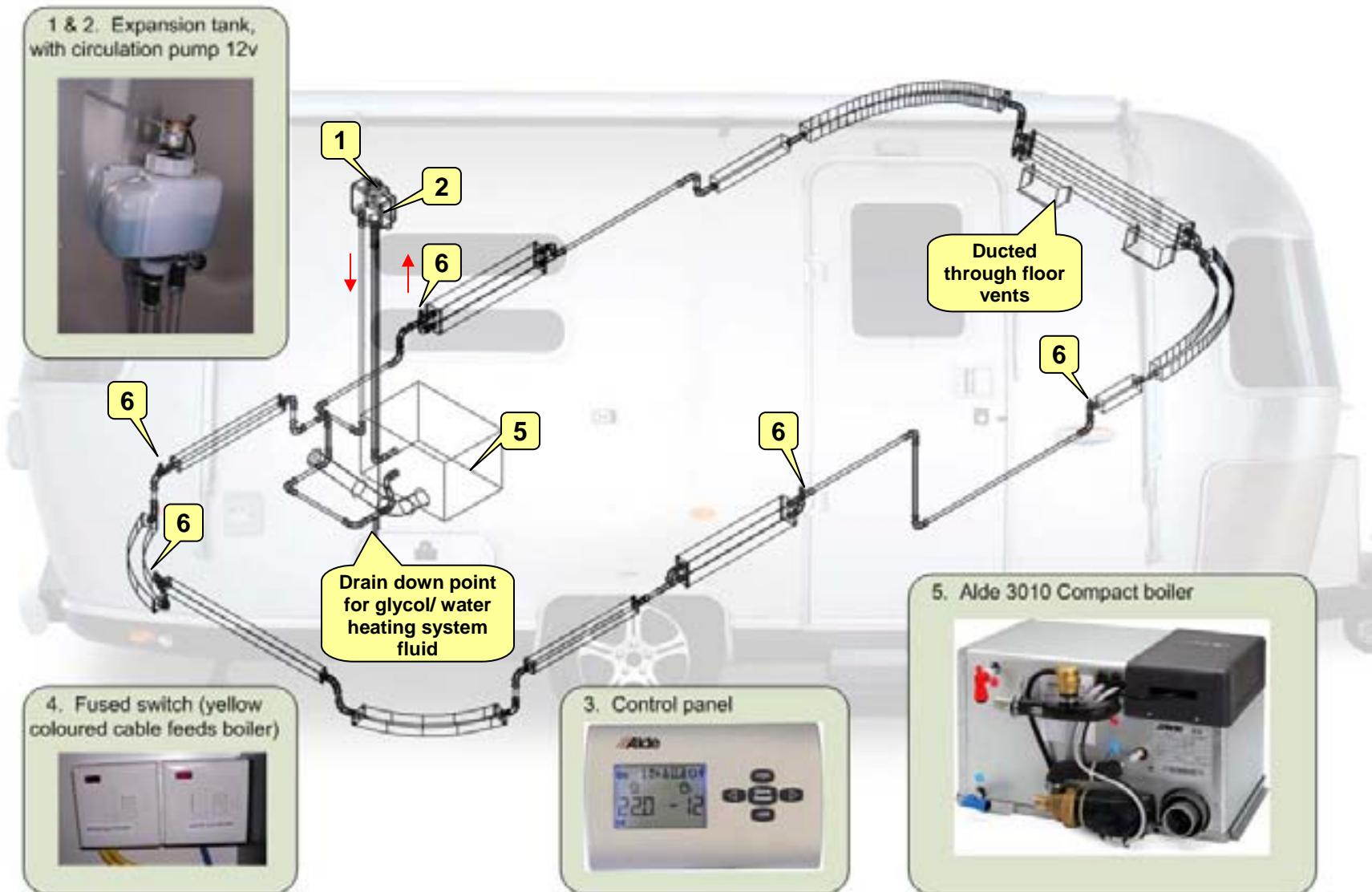

ALDE COMPACT 3010 BOILER

The Alde Compact 3010 boiler consists of three eccentrically fitted cylinders – heat exchanger, water jacket for the heating system and outermost, water jacket for hot water:

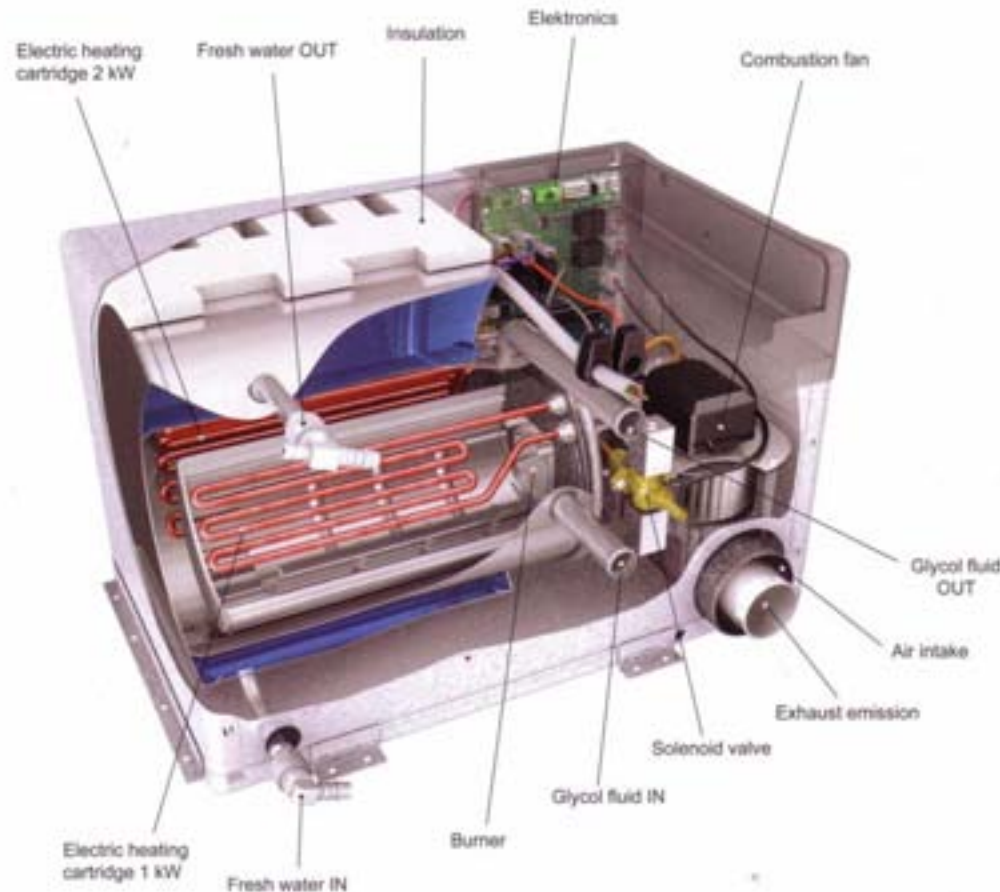

AIRSTREAM + ALDE - HEATING SYSTEM DESIGN

All European specification Airstreams are equipped with the Alde 3010 Compact boiler, providing hydronic (wet) central heating and hot water.

The Alde system has been integrated into each new European Airstream floorplan from the outset.

First the number and type of convectors is planned carefully to ensure maximum heat output and even heat distribution. Special curved and flattened convectors were developed for the Airstream shell.

Next the joinery is designed in detail, to provide maximum air circulation to the network of convectors and pipes in the backs of cabinets and seats etc.

The fact the joinery is designed to suit the Alde system, rather than visa versa, is key to end performance.

Cold chamber testing was used to identify areas for improvement, before production commenced. In final testing Airstream achieved the toughest grade, Level 3 for heat up performance. Level 3 requires that with an external temperature of -15, the vehicle must go from -15 to +20 in less than 4 hours.

Benefits of the Alde system include even heat distribution, maximum efficiency, silent operation and minimal circulation of dust and allergens. Maximum comfort for mobile living.

For more information, ask your Airstream dealer for a copy of Alde's DVD presentation:



I3 – Control panels

A choice of control panels is available for use with the Alde Compact 3010:

DIGITAL CONTROL PANEL

This is the control panel normally fitted.

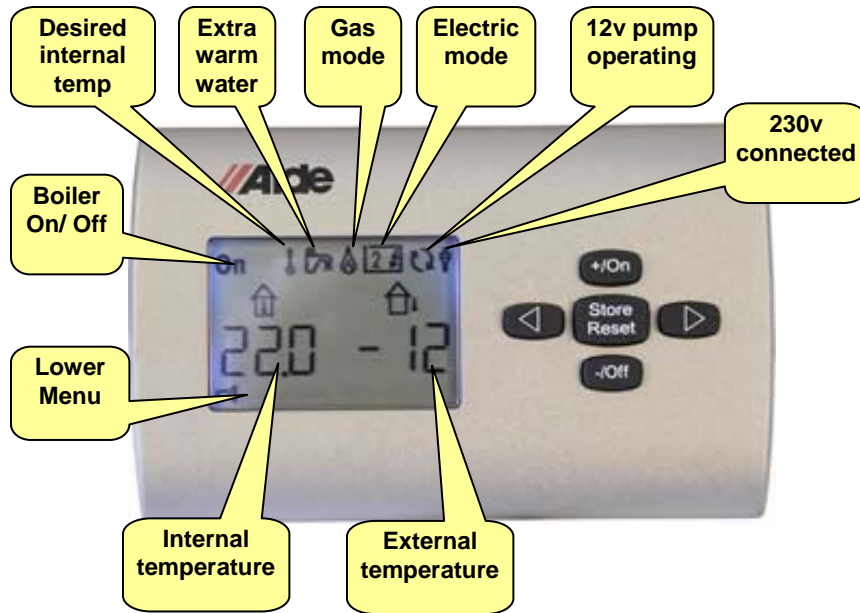

Refer to Alde's Operating Instructions for detailed instructions on operation of the control panel functions.

This digital control panel incorporates an electronic thermostat.

TOUCH SCREEN CONTROL PANEL

For 2010, this touch screen panel has been designed to be more intuitive. It will be interchangeable with the digital control panel.



The touch screen control panel can be purchased as an optional extra from your Airstream dealer for retro-fitting to an existing unit, or specified for new units at the date of purchase.

Alde will release instructions for this panel when it is available.

NORMAL OPERATION

Check fluid level in expansion tank (1). This should be at least 10mm above the minimum mark when cold. See later instructions in this section for adding more heating system fluid if necessary.

Check status of Alde control panel (2). If there is no display, turn the electronic control panel ON.

Select the fuel type on the Alde control panel, that you wish to use.

First program the electric operation to suit the electricity supply available where you are camping – 1 immersion will draw 4.5amps, 2 immersions will draw 9amps.

All Alde 3010 Compact boilers fitted to European specification Airstreams are supplied with 2 x 1kW electric heating cartridges/ immersion elements, giving a maximum output of 2kW on electric operation.

Select gas operation if:

- You are camping on a site without 230v electric hook up, or limited supply (say 5A).
- You want the boiler to heat up rapidly - heat up time will be faster on gas, than electric operation. The output on gas operation is up to 5.5kw using propane, over 2.5 times more than the maximum 2kw for electric operation.
- External temperature is near freezing, or below. Electric only operation will maintain a 15 - 20C differential between external ambient and internal temperature. As external temperature drops to freezing, gas operation will be required to maintain a warm internal temperature (say +20C).

To force the boiler to ignite on gas operation, turn the electric operation off.

NOTE: Electric and gas operation can be selected at the same time. The boiler will prioritise electric over gas and only use gas, when necessary.

CAUTION! Do not turn the boiler on unless the pipework/ convectors and inner water jacket for the heating system is full of glycol/ water. Check that the expansion tank contains water/ glycol (photo below).

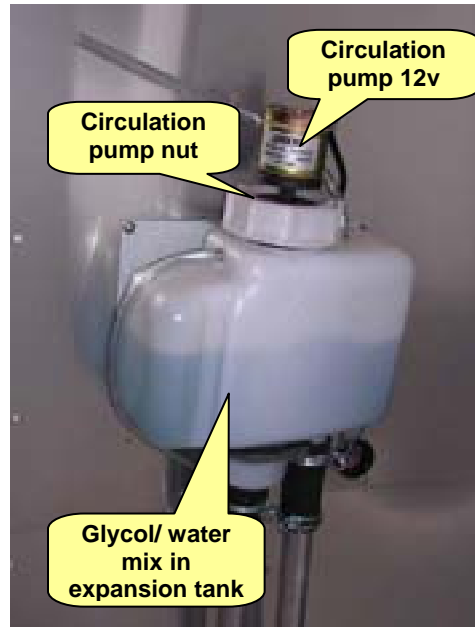

Turn boiler ON at control panel.

Set the desired internal temperature to turn the heating ON. *NOTE: for heating to come on, the desired internal temperature must be set to above current internal temperature.*

IS THE HEATING WORKING?

Listen:

- On gas operation, you will hear the boiler combustion fan come on, followed by the spark noise of the burner igniting. On electric operation you will hear the relays click as the boiler is turned on and off.
- With gas operation, go outside and listen for noise of gas flowing at the LP compartment. Then place your hand near the boiler flue externally and check for warm flue gases.
- Listen to the noise from the expansion tank (only applicable to installations using a 12v circulation pump in the expansion tank). A louder than normal gurgling noise indicates the pump is only circulating the fluid inside the expansion tank (rather than the whole system), indicating there is an air lock in the system. Follow later instructions in this section for bleeding trapped air.

Touch:

- Verify pipework is coming warm by touching pipework at the front and rear of the Airstream and by the boiler & expansion tank.
- Turn on a hot tap and verify water is becoming warm.

Look:

- Verify 230v electrical hook up emblem shows on Alde control panel. Verify 12v circulation pump symbol appears on the control panel.
- Monitor rising internal temperature on digital control panel.

I4 – Heating, normal operation

HEATING WHEN AIRSTREAM IN STORAGE

See Section D4 of this Manual for advice on the options you have when deciding how to store the Airstream in winter months.

AUTOMATIC TEMPERATURE CHANGE

Some customers prefer a cooler internal temperature at night.

The digital control panel allows an automatic temperature change to be set, follow the Alde Operating Instructions for accessing the 'Automatic Temperature Change' function, in the lower menu of the digital control panel:

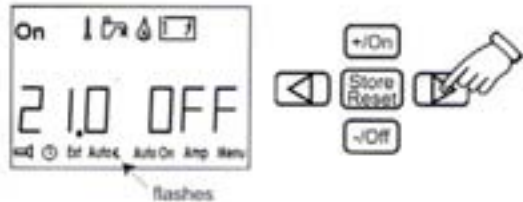

USE OF HEATING WHEN DRIVING

The Alde 3010 boiler can be used when the Airstream is being towed, but with the following caveats:

- 1) The user is responsible for checking that this does not contravene any national laws in the country of use.
- 2) To operate when the Airstream is connected to the towcar, the 12v system in the Airstream needs to be modified by your dealer to provide a permanent live 12v positive supply to the boiler. Otherwise the Alde system parts needing 12v will not operate once the car ignition is turned on.
- 3) The boiler must not be operated on LPG when re-fuelling at a petrol station.

HOT WATER

The outer water reservoir of the boiler stores the domestic hot water (capacity 8.4 litres). This is filled with cold water when priming the water system.

This outer hot water reservoir can be empty and the heating system still used safely, so long as the heating system has been filled with glycol/ water.

Hot water will be supplied when this outer water reservoir has been filled and the boiler is turned on.

To have hot water but no heating, turn the boiler ON, then turn the heating OFF (by reducing the desired internal temp. to below the current internal temp.).

WARNING! Hot water temperature can be high from the hot tap, particularly if the boiler is operated on gas and the extra warm water function is selected. Take care to prevent scalding when using taps/ showers without thermostatic mixers.

The hot water temperature can be checked from the digital control panel by accessing the lower menu and checking the SH reading. See Alde's Operating Instructions.

EXTRA WARM WATER FUNCTION

Turning on the warm water function, accessed by the tap emblem on the digital control panel, increases the hot water temperature from 50 Celsius to 65 Celsius for 30 minutes. See Alde's Operating instructions for full details. In our experience hot water is often quite hot enough anyway, so use this function with care.

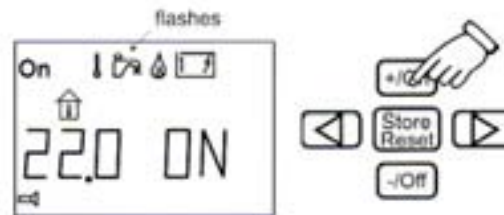

DRAINING HOT WATER RESERVOIR OF BOILER

When the boiler is in continuous use supplying hot water (if the Airstream is being lived in full time for example), the hot water reservoir should be emptied approximately once a month.

This is necessary to ensure that a new air cushion is formed in the water heater. The air cushion is essential for absorbing pressure surges in the heater.



See section F5 for the full drain down procedure. Locate the drain down point with yellow lift lever (photo adjacent) closest to the boiler. If you are unsure of its position, ask your dealer.

Switch off the water pump. Open all water taps – this is necessary to ensure that air can enter the hot water reservoir as water is emptied out – and leave them open. Then open the hot water reservoir drain down point, by raising the yellow lever to the vertical position.

Check that all the water is emptied out (about 7-10 litres). Leave the yellow lever in the vertical (open) position until the next time the water system is filled.

! CAUTION. The hot water reservoir of the boiler should always be drained of water when there is a risk of frost and when the Airstream is not in use. The warranty does not cover frost damage.

ADDITIONAL CIRCULATION PUMPS

A multi speed 12v pump is available from early 2010. This is fitted to the boiler, rather than in the expansion tank.

The multi speed 12v pump can be set up to 4 times faster than the standard 12v pump, by turning up the speed select dial on the pump (**left photo below**). This makes it easier for customers to bleed air from the system.

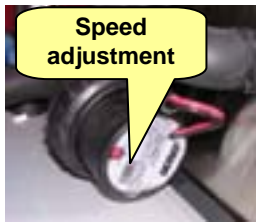

12v pump



230v pump

A new 230v pump is also available (**right photo above**), which is more powerful than the 12v pumps. It is lighter than previous 230v versions.

The 230v pump can benefit people touring (provided the site has 230v hook up), as the heat up time is faster - internal temperature should get to 20 degrees approx 20 minutes faster.

The 230v pump is recommended for customers living full time in their units, or using them intensively in winter. The more powerful 230v circulation pump is better suited for continuous use of the heating in winter months.

Again the 230v pump helps bleed air out of the system, which the 12v pump in the expansion tank alone cannot do.

Both the above pumps can be retro fitted, ask your dealer for a quote. In both cases, the standard 12v pump in the expansion tank should be retained.

HEATING - BLEEDING TRAPPED AIR

If areas of pipework/ convectors remain cold, this indicates air is trapped somewhere in the system.

Follow the instructions below to bleed trapped air.

First turn off the heating. Reduce the desired internal temperature to below the current internal temperature. The circulation pump will then stop and fluids in the system will settle. This allows trapped air to rise to the highest points of the system.

Identify the positions of bleed points (**6**) in the system, ask your dealer if you are in doubt about their location in your Airstream. Most floorplans contain 4 or more bleeder points.

Some are concealed behind 75mm white caps in seating or mattress backrests (**left photo below**). Each bleed valve has a round finger turn dial (**right photo below**), turn this anti-clockwise to open.



75mm cover

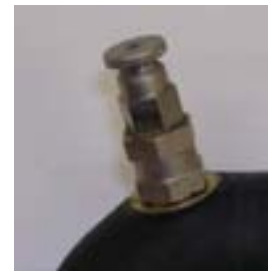

Bleed valve



If a heated towel rail is provided in the bathroom, this has a small bleeder screw point on the top rail, for which a radiator key is required (**adjacent photo**).

Open each bleed point in turn, until they start discharging fluid, then close them.

Then turn the heating back on, to re-start the circulation pump and leave it running for a while, ideally overnight.

If the cold areas of the system still do not warm up, try raising and lowering the front of the Airstream, whilst opening the highest bleed point:

- Stop the circulation pump. Lower the front of the Airstream as much as possible. Leave it in this position for a few minutes to allow the air to travel upwards in the system. Then open the highest bleed point in the system. Leave it open until it discharges glycol fluid.
- Then raise the front of the Airstream as much as possible and repeat the above procedure. Then position the Airstream horizontally and start the circulation pump.

If the cold areas of pipework/ convector still do not come warm, then contact your Airstream dealer.

16 – Heating, maintenance

ADDING MORE HEATING SYSTEM FLUID

After establishing that the system is now warm throughout, check the level of fluid in the expansion tank. The level will drop after bleeding, as air in the network of pipes and convectors is replaced with the glycol/ water.

The fluid level should be at least 10mm above the MIN mark when the system is cold.



To manually add more fluid if necessary, first turn off the circulation pump.

Then unfasten the circulation pump nut (R) and lift the pump (S) out of the tank.

Slowly pour more fluid into the tank.

The fluid should preferably be well mixed glycol/ tap water to a 50/50 dilution. Avoid using pure glycol as this tends to not mix well/ sludge in the system. It is better to use all water, than all glycol.

A well prepared owner will keep a ready to use 1 litre bottle of pre-mixed glycol/ water in the Airstream.

HEATING SYSTEM FLUID REPLACEMENT

Periodically the heating system fluid must be drained down and replaced, as the Glycol loses its anti corrosive and lubrication properties over time.

The frequency of replacement depends on the type of Glycol used:

- standard blue Glycol – replace every 2nd year
- Super Long Life Red Glycol (made by Comma) – replace every 5 years

The standard dilution mix is 60% water and 40% Glycol, which gives freezing protection to -25 Celsius.

If the heating system will be exposed to temperatures below -25 Celsius, then the Glycol percentage should be increased to 50/ 50. This will give protection to -36 Celsius. It is important the solution is well mixed.

Complete drain down and replacement of the heating system fluid is best done by your dealer.



First, the dealer will drain down the existing heating system fluid, by removing the brass plug to the drain down point below the floor (**photo adjacent**).

Then a Service Pump is used (**photo top of next column**) which quickly both fills and bleeds the system automatically.



OTHER ANNUAL SERVICE CHECKS

- Inspect the boiler's air inlet and exhaust outlet hose. Check that the hoses are still secured and undamaged, and that the external flue is clear and free of obstruction.

SPARE 12V CIRCULATION PUMP

TIP! Customers using the Airstream intensively during winter months using only the standard 12v circulation pump in the expansion tank are strongly recommended to purchase a spare 12v circulation pump.

Carrying a spare 12v circulation pump would allow immediate replacement should the circulation pump fail during periods of heavy use in freezing weather, when it is under most strain.

Order the pump direct from your local Alde dealer (UK: Alde UK on 00 44 1933 677765).

No display on Alde control panel:

- Main electronic control panel not turned on.
- Blown 12v fuse on Sargents PSU – see 12v charts in Electrical section of this manual.
- Blown fuse to Alde boiler – speak to your dealer.

'Gas out' flashes on Alde control panel:

- Set gas operation to OFF on Alde control panel. Then try lighting cooker gas ring to see if gas is being supplied to cooker.
- Check the gas cylinder valves are turned on, one or more cylinders have gas inside, the regulator test button has been pressed. Then check that the manifold tap serving the boiler is in the open (vertical) position.
- Then set the Alde control panel gas operation to ON. Repeat this procedure 3-4 times as necessary to purge air from the gas line. Once the boiler ignites on gas, you will feel heat coming from the wall flue externally.

Areas of convector remain cold, load noise from 12v pump circulating in expansion tank:

- Airlock in system, follow instructions earlier in this section for bleeding trapped air.

Erratic function:

- This can occur if buttons are pressed in error on the control panel, changing settings. Press the Store/ Reset button for 10-20 seconds.



The control panel will be reset to the factory settings (boiler OFF, Gas ON, Electricity at 1kW and heating set at 22 Celsius)

Section J – Audio visual



Overview	J1
Normal operation	J2
TV/ FM antenna, directional	J3
TV/ FM antenna, omni-directional	J4
Other audio visual equipment	J5
Satellite dish	J6
Satellite receiver	J7
Audio visual schematic	J8
Maintenance	J9
Troubleshooting	J10

J1 – Audio visual, overview

Typical European specification Airstream audio visual equipment:

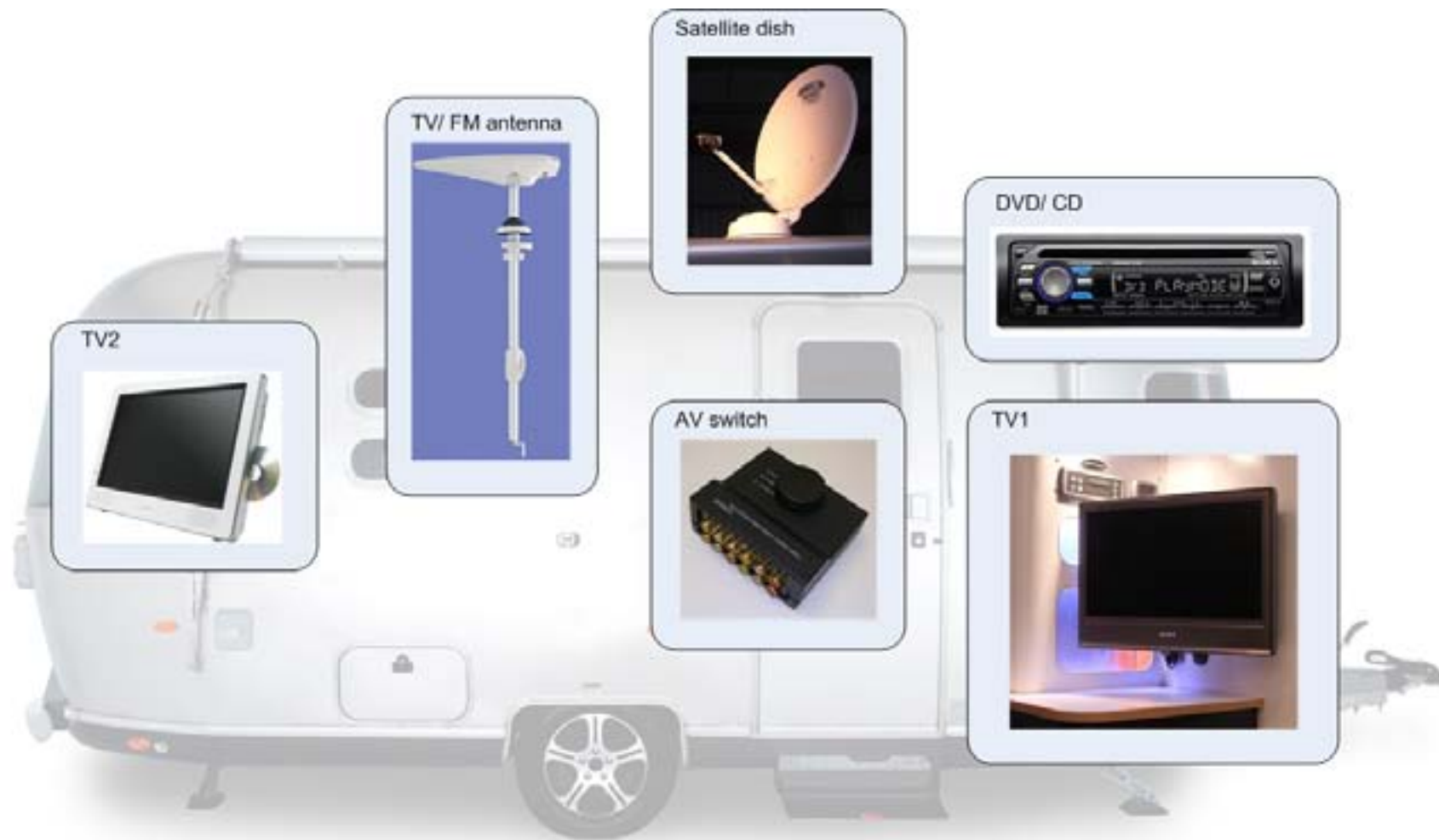

Equipment may vary according to options chosen (only the 684 is pre-wired for roof top satellite), positions are illustrative only, not to scale.

J1 – Audio visual, normal operation

This page is a checklist only. For detailed operating instructions on all the equipment mentioned below, see the subsequent pages of this section.

TERRESTRIAL TV (VIA TV ANTENNA)

1. Directional antenna (532/ 534 and 684):
Raise TV antenna, adjust to suit direction and polarity of nearest TV transmitter.
2. Omni-directional antenna (422):
No specific action required.
3. Turn on TV(s) and select TV (rather than AV) channel.
4. Auto-tune each TV to find the strongest channels. The TV will scan first for digital channels, then again for analogue channels.

To have terrestrial TV sound coming through ceiling speakers:

5. Turn on DVD/CD and press source button on DVD/ CD fascia until 'AUX' is displayed, then press mode button if required so 'REAR-IN' is displayed.
6. Turn AV switch (in cupboard by entrance door) to position 3 (DVD) – *534 and 684 only.*

Additional requirement for 2007/08 models only:

7. Access scart switch to rear of TV1. It has a small switch on the bottom of the scart plug connected to the rear of the TV. This switch has to be pushed over for sound to pass from TV1 up to the DVD/CD unit. NOTE: You will need to move this switch back to the other position to watch a DVD – or no picture will be displayed.

DVD PLAYBACK USING DVD/CD

1. Press & hold OFF button to turn DVD/ CD on. Insert DVD. Player will automatically select DVD playback mode.
2. Turn AV switch (in cupboard by entrance door) to position 3 (DVD) – *534 and 684 only.*
3. Turn on TV. 20" SONY TV requires 230v to operate, but 12v DC-230v AC inverter can be fitted. Or choose a TV which can operate off 12V DC, like the Avtex.
4. Select AV channel on TV which the scart lead behind the TV is plugged in to (usually AV1).

Additional requirement for '07/08 models only:

5. If TV1 will not display the DVD playback, access the scart switch to the rear of TV1. Move the small switch on the bottom of the scart plug connected to the rear of TV1 to the other position.

MP3 OR PORTABLE VIDEO PLAYER

1. Turn AV switch (in cupboard by entrance door) to position 2 (MP3) – *534 and 684 only.*
2. Connect portable player to 3 way AV plate set into front shelf of Airstream, under front window.
3. Turn on DVD/CD and press source button on DVD/ CD fascia until 'AUX' is displayed, then press mode button if required so 'AUX-rear' is displayed.
4. To view images, turn on TV and select AV channel on TV which the scart lead behind the TV is plugged in to (usually AV1).

SATELLITE TV

(roof mounted Satellite dish – 684 only)

1. Press on/ off button on Satellite control panel to raise roof mounted satellite dish.
2. Press Sat button if required to select the desired satellite (Astra 28 for UK viewers). Wait for dish to find satellite, at which point 'SAT' will show on satellite control panel display.
3. Turn AV switch (in cupboard by entrance door) to position 1 (SAT).
4. To have sound coming through the ceiling speakers, turn on DVD/CD and press source button on DVD/ CD fascia until 'AUX' is displayed, then press mode button if required so 'AUX-rear' is displayed. Alter volume using the DVD/ CD remote control (not the TV remote control).
5. Turn on TV1, select AV channel on TV which the scart lead behind the TV is plugged in to (usually AV1).
6. Turn on Satellite receiver (top right button on receiver remote control) so LED on player is green. Change channel using SKY remote control.
7. Turn on TV2 (if fitted).
8. Satellite signal is delivered to TV2 via coaxial cable, auto-tune TV2 if required to find channel delivering satellite image.

For troubleshooting, see the last pages of this section.

J3 – TV/ FM antenna, directional

STATUS 530/10 digital/ analogue directional TV & FM antenna

(use: all International models)

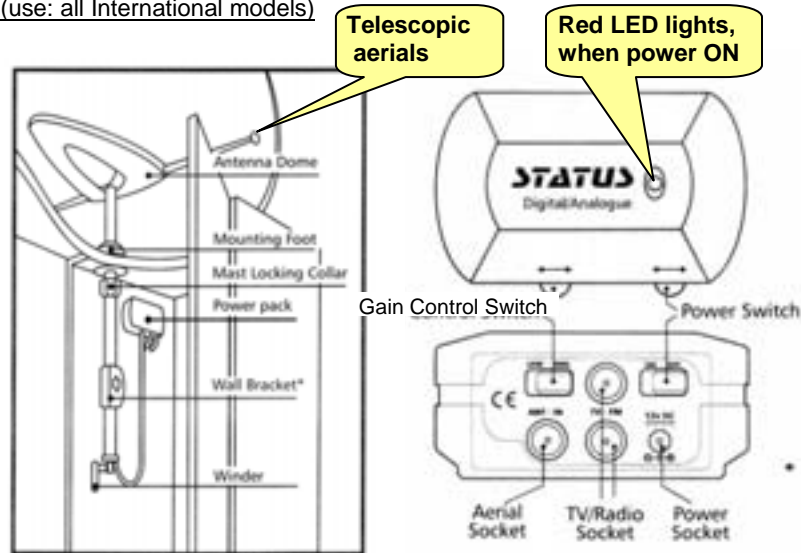

TRAVELLING

Prior to travel, turn the winder handle clockwise to ensure the antenna is back in the horizontal position. Then lower the mast. Turn the mast as necessary so that the red spot on the bottom of the mast points to the rear of the Airstream.

CAUTION! Do not travel:

- With the antenna raised
- With the antenna angled vertically
- With the telescopic aerials extended

GAIN CONTROL SWITCH

The gain control switch on the Status power pack should be set to the normal 'NML' position for general use. The Low setting may be used when situated close to TV transmitters where strong signals may be affecting the quality of the picture.

OPERATION

On arrival, establish the approximate position of the nearest transmitter and whether the signals are horizontally or vertically polarised (some TV broadcasting stations transmit in the horizontal plane, others in the vertical plane). Ask the site operator or check other antennas in the vicinity.

1. **Loosen** the mast locking collar and wall bracket lock nut as necessary, to enable the mast to be raised.
2. **Turn** the mast to direct the antenna towards the nearest TV transmitter. The red spot on the bottom of the mast indicates the front of the antenna.
3. **Rotate** the winder handle anti-clockwise to cant the antenna - to alter the antenna orientation from horizontal to vertical, if signals are vertically polarised.
4. **Turn on** TV(s) and auto-tune to find the strongest channels. Re-tuning may be necessary at all new camping locations. You may need to adjust the mast direction to achieve the best picture quality.
5. **Re-tighten** the mast locking collar and wall bracket lock nut to secure mast in extended position.

USE OF TELESCOPIC AERIALS

- You **DO NOT** need to extend the telescopic aerials for FM radio reception.
- You **DO** need to extend the telescopic aerials to receive VHF television reception (in continental Europe). **NOTE:** VHF TV transmissions are **ONLY** horizontally polarised.

To extend the telescopic aerials, you need to safely access the TV antenna on the roof of the Airstream. If using portable steps, get another person to hold the steps before you climb them. The TV antenna dome will need to be in the fully lowered position. Pull out the aerial on the outboard side of the antenna, then rotate the antenna to access and pull out the 2nd aerial.

CAUTION! Do not cant the antenna to the vertical position when the telescopic aerials are extended, this risks damage of the aerials if they hit the roof/ other roof level equipment.

STATUS 315 digital/ analogue omni-directional TV & FM antenna

(use: Bambi 422)

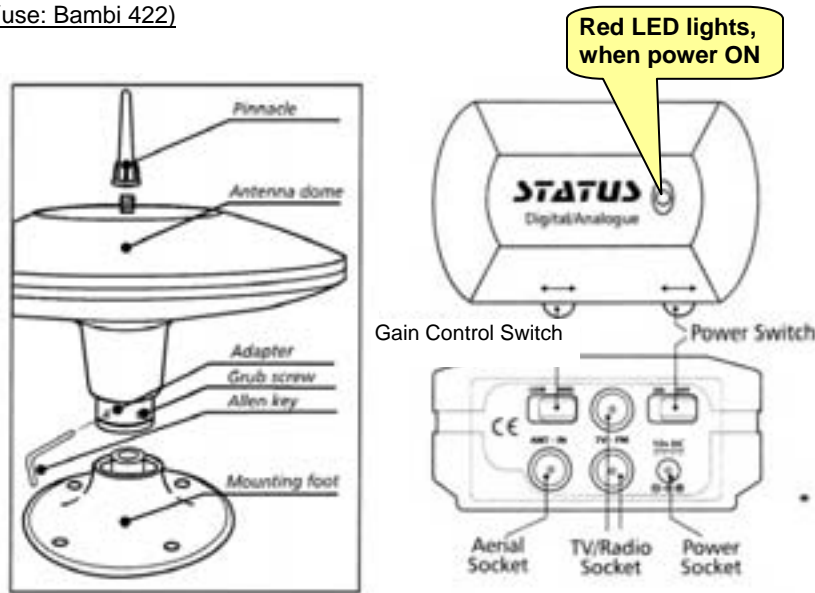

OPERATION

No specific action is required when arriving on site, except to check from time to time that the antenna is mounted level.

Turn on TV(s) and auto-tune to find the strongest channels. Re-tuning may be necessary at all new camping locations.

ANGLE ADJUSTMENT

If the mounting angle needs adjustment, remove the antenna dome from the mounting foot and turn the antenna dome upside down. Loosen the central both with a screwdriver, adjust the adapter to the desired angle and then re-tighten the central bolt.

For further information on both the Status 530/10 and Status 315, see the manufacturer's operating instructions, contained in your owner's pack.

Manufacturer: Grade UK Limited, www.gradeuk.co.uk

AV SWITCH

The AV switch (left photo below) controls the audio visual inputs to TV1.



12V TV AMPLIFIER

Floorplans with more than one internal TV viewing position have an additional 12v TV amplifier (right photo above). The blue LED is illuminated when the unit is powered.

SLX REMOTE CONTROL EYE

The remote control eye (photo below) is fitted as part of the satellite system. The satellite receiver is installed in a hidden location, so remote control eyes are fitted to each TV to allow the satellite receiver remote control to operate.

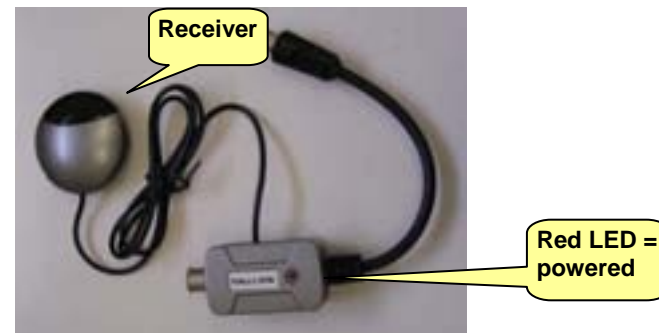

J6 – Satellite dish

SATELLITE TV – THE BASICS

Satellite TV offers 2 major advantages over terrestrial TV:

- access to potentially many more TV channels
- good TV reception via the satellite dish, in areas where terrestrial TV reception via the TV/ FM antenna is poor.

To receive satellite TV, a dish and receiver are required. The receiver decodes the signal and produce a picture on the TV(s).

TELECO MAGICSAT EASY 850

The Magicsat Easy 850, manufactured by Teleco, is a fully automatic satellite tracking system, mounted on the roof of the Airstream.

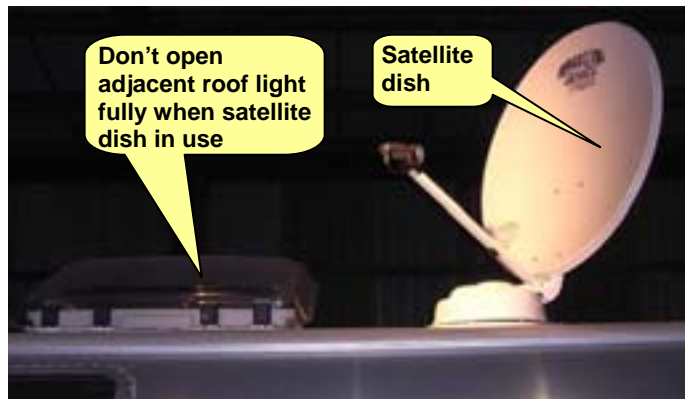

CAUTION! Do not open any adjacent rooflights to more than the half open position when the satellite dish is in use, or the dish may hit the rooflight dome when the dish is rotating.

CAUTION! Lower the satellite dish in windy weather, as strong gusts of wind may catch the dish and damage the motor.

CAUTION! Always check the dish is parked/ folded flat down against the roof before travel.

For further information, refer to Teleco's User Manual.

Satellite system wiring schematic:

Only the 684 model is pre-wired for the Magicsat Easy 850 system, but it can be fitted to all models subject to available roof space.

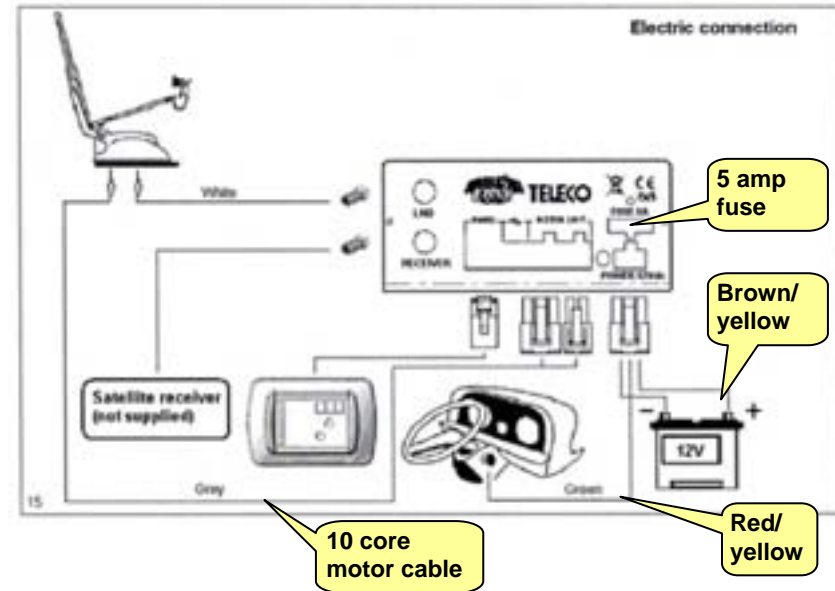

Satellite control panel:



PACE JAVELIN 1000 DIGITAL SATELLITE RECEIVER (Sky minibox)

Different countries will require different satellite receivers.

For UK customers, the Pace Javelin 1000 is a 12v SKY receiver of compact dimensions, which enables the user to watch some channels, EG BBC1, BBC2, BBC3 in the UK without a viewing card.



To receive other channels, for example C4 and C5 in the UK, the user can purchase a Freeview card for the receiver, available from a variety of retail outlets.

To receive further channels, for example the full package from SKY including Sky sports/ movies etc., it is necessary to subscribe to SKY. Users who already have a SKY subscription, can request a 2nd card for a 2nd receiver in another bedroom.

Remote control

To turn the Sky minibox on using the remote control, press SKY on the remote control. To turn the Sky minibox off, press the standby key.



For full instructions on use of the receiver and the remote control, refer to the receiver manufacturer's manual.

Satellite receiver, typical connectivity:

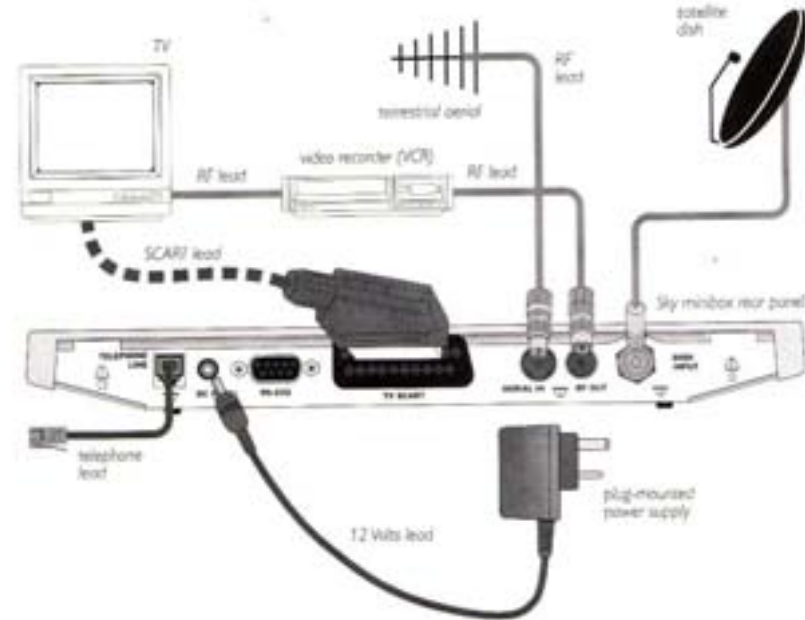

J8 – Audio visual, schematic

This example is for the Airstream 684:

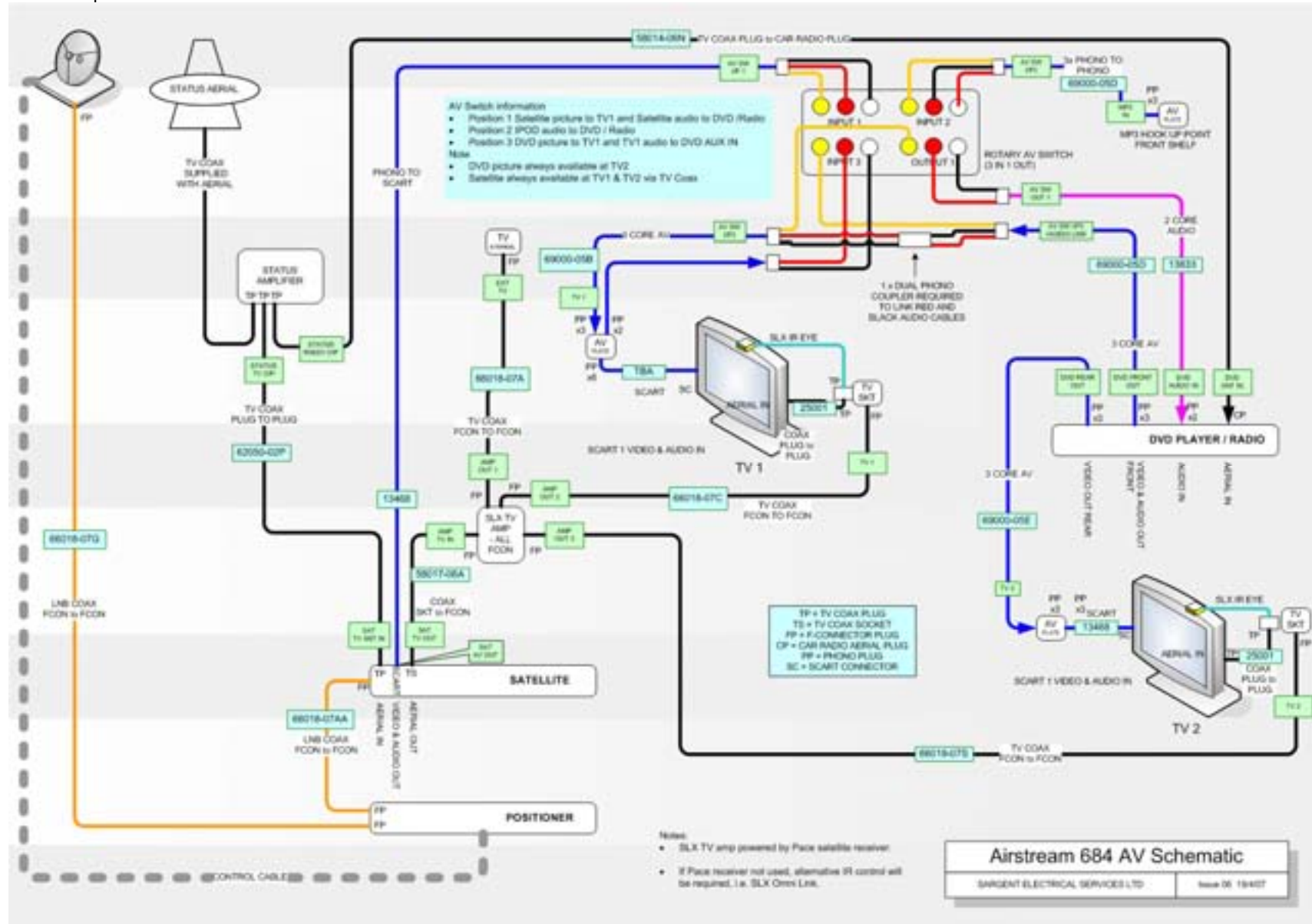

SATELLITE RECEIVER SOFTWARE UPDATE DOWNLOAD INSTRUCTIONS

In a static installation at home or the office, a satellite receiver remains permanently connected and is able to download software updates as they are transmitted.

When used in a mobile installation, in which the receiver will be switched off for much of the time, the user may need to download a software update from time to time. The instructions for doing this are given below:

1. The satellite dish needs to be raised and locked on to the relevant satellite (Astra 28 in the UK).
2. Turn the TV on, select channel AV1 on the TV and select position 3 on the AV switch, so the satellite receiver menu is displayed on the TV.
3. Turn off power to the satellite receiver. Do not remove the 12v power jack plug from the back of the receiver, as this will short and blow the fuse (Fuse 9 – EC325). To turn off the power easily, a rocker switch needs to be installed in the yellow/ white (+ve) supply of the 12v power lead to the satellite receiver. If there is no rocker switch installed, speak to your dealer. Turn the rocker switch to the '0' position to turn off the power.
4. Press and hold the back up button on top of the receiver.
5. Whilst keeping the back up button pressed, turn the power to the satellite receiver back on (turn the rocker switch to the '1' position). Keep the back up button depressed until all 4 LED lights come on to the front of the receiver, which will indicate the software download procedure has started.

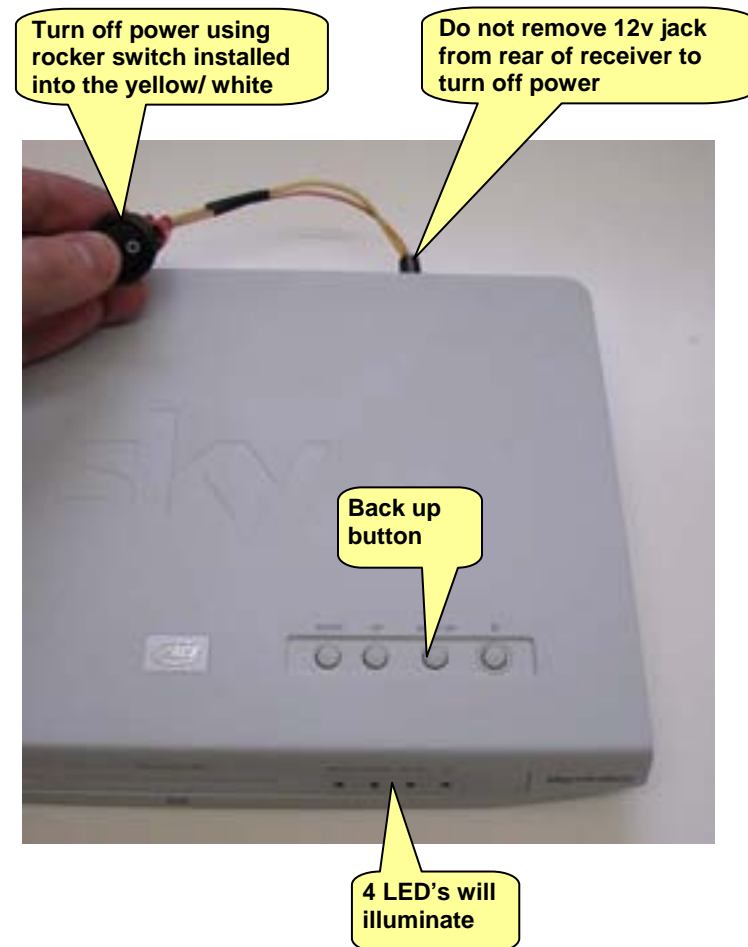

J10 – Audio visual, troubleshooting

POOR OR NO TV PICTURE (TERRESTRIAL TV)

During commissioning of the Airstream, the co-axial cables, connections and amplifiers are checked by inputting a known good signal (from a satellite system) into the ANT-IN socket of the Status amplifier and then verifying that a good picture is displayed on each TV.

If you experience problems in use, check the following before calling your dealer:

- Verify the red LED on the Status power pack amplifier is illuminated. If not, check the power switch on the amplifier is turned ON. Check the 12v fuse on the Power Supply Unit (EC325 – Fuse 9, EC155 – Fuse 7).
- Verify the Coaxial TV plugs are connected to the Status power pack, to the rear of the TV(s) and to the co-axial socket on the wall adjacent to the TV.

NO POWER TO SATELLITE CONTROL PANEL

Is main electronic control panel for the Airstream turned on, so lights etc. are working?

Check fuses:

- Remove top drawer from furniture unit nearest trailer entrance door to access Teleco control box, which is fixed to the wall in the back of this unit. Pull out the 5 amp fuse located in the bottom of this control box.
- Check 3rd fuse from left on EC325 Power Supply unit, labelled '03 – 5A permanent supply'.

NO SATELLITE PICTURE TO TV2

If there is no picture to TV2, auto-tune the TV to find the channel delivering the satellite picture.

REMOTE CONTROL EYES NOT OPERATING

The remote control signal is picked up by an infra red receiver 'eye' positioned on top of the TV, from where the signal passes down co-axial cable to the satellite receiver located under the 2nd drawer of the furniture unit nearest the trailer entrance door.

If pointing the SKY satellite remote control at the TV does not work, first access the SKY receiver (684 - remove the 2nd drawer down of the unit near the entrance door), so the Satellite receiver is visible. Try pointing the remote directly at the satellite receiver, or pressing the on/ off button on the satellite receiver itself.

If this works, then follow the procedure below to re-program the satellite receiver to accept the infra red signal down the co-axial cable.

On SKY remote control, press or select as follows:

- Services,
- System Set Up
- 01
- Select
- RF outlets (scroll until this option is shown)
- Turn power on (use left and right arrows to turn on and off)
- Save
- Exit

Section K – Appliances - other



Toilet
Smoke alarm
Refrigerator
Cooker
Tracker
Air conditioner
Mover

K1
K2
K3
K4
K5
K6
K7

K1 – Vacuum toilet, overview

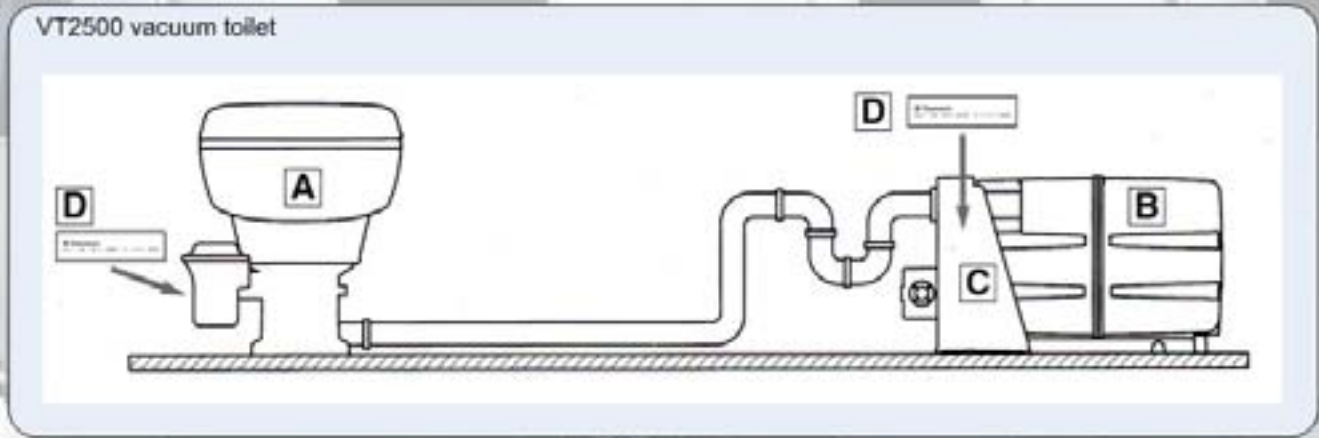
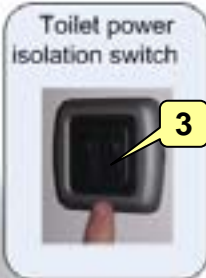
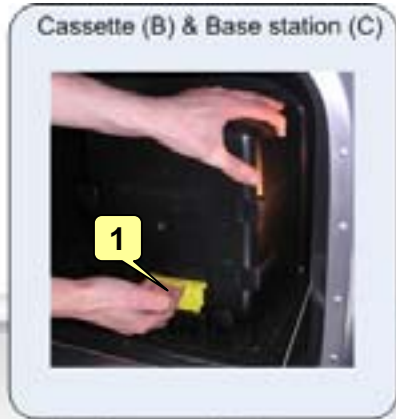
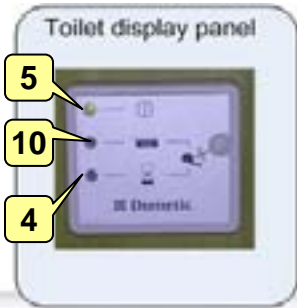

STEP BY STEP OPERATION

Insert empty clean cassette **(B)** onto base station **(C)**. When inserting the cassette, lift the yellow locking latch **(1)** with one hand, then let it drop once the cassette is fully in.

Turn on the power ON **(2)** at the main electronic digital control panel, then turn on the toilet vacuum pump isolation switch **(3)**, usually on the wall of the bathroom or wardrobe – ask your dealer.

Once the power supply is switched on, the toilet vacuum pump will run for approximately 1 minute to build the vacuum, during which time the yellow LED light illuminates on the display panel **(4)**. Once the pump has stopped running, the green LED light illuminates **(5)** to indicate the toilet is ready for use.

Check water supply is connected (internal tank full, or external tank filled and connected – **7**) and water pump is turned on **(8)** at main electronic control panel.

Lifting the toilet pedal **(9)** to allow a little water to flow into the bowl.

Only urine and human faeces liquid/ solid waste and quickly dissolving 2 layer commercially available toilet paper, such as **Thetford Aquasoft**, should be put into the bowl and flushed.

The toilet can only be flushed when the green LED light **(5)** is illuminated on the display panel. Close the lid to the toilet bowl, then press the pedal on the left side of the toilet to flush.

EMPTYING

The cassette capacity is 14 litres. Normally approximately 0.4L of water is sufficient for each flush. Economizing on the amount of water and paper used will extend the time interval between emptying the cassette, but do not flush without water, as this risks blockages!

When the cassette is full (or has been removed), the red LED light **(10)** will illuminate on the display panel.

To remove the cassette, raise the yellow locking latch **(1)** with one hand whilst pushing in the cassette slightly with the other. Then pull out the cassette using the carrying grip on top of the cassette.

Carry the cassette to the emptying location, usually the closest toilet connected to mains drainage. Unscrew the cap to the cassette and tip contents into the emptying receptacle.

DO'S AND DON'T'S

DO NOT place any non dissolving or solid objects into the toilet. For example kitchen paper towels, cleaning wipes, facial tissues etc are slow dissolving/ highly absorbent and will block the pipework and can damage the system!

DO NOT use excessive quantities of toilet tissue as again, this will increase the risk of blockages.

DO NOT press the foot pedal whilst sitting on the toilet or if the seat lid is open!

DO NOT pour chemicals into the toilet bowl, or cassette, other than those products specifically recommended (see next page) for the VT2500. Use of chemicals risks deterioration of the silicone grease and rubber to the numerous O ring seals, causing air leakage problems.

DO..... always flush with water. Dry flushing of faeces and toilet paper will cause blockages. Should pumped water not be available for any reason, use bottled water poured into the toilet bowl before flushing.

TIPS FOR USE

NOTE: The VT2500 toilet bowl (A) is designed for leisure use. New or existing customers using their Airstream for the equivalent of 3 months full time use or more per annum should consider upgrading the toilet bowl to an all ceramic marine toilet bowl, ask your Airstream dealer.

Close the seat cover before flushing the toilet, this will reduce the noise.

When using the toilet for the last time before going to sleep, let the vacuum pump recharge the vacuum as normal, then turn off the toilet vacuum pump isolation switch **(3)**. If anyone uses the toilet in the night, the existing vacuum will flush the bowl contents, but the vacuum pump will not come on again, thus reducing disturbance to others nearby.

When leaving the Airstream, turn the toilet vacuum pump isolation switch **(3)** off. This will prevent the pump running if there is a loss of vacuum in the system for any reason. Similarly, the water pump is best turned off.

Customers intending to camp in areas without a suitable toilet emptying location nearby, can buy an additional cassette to double the storage capacity.

When screwing the cap to the cassette back on after emptying the cassette, ensure the cap is screwed on tightly to create an air tight seal.

K1 – Vacuum toilet, cleaning & maintenance

CLEANING & MAINTENANCE

Rinse the inside of the cassette thoroughly with fresh water each time it has been emptied, to ensure all contents are removed. Otherwise a build up of toilet paper/ debris can clog the tank full float inside the cassette.

Plastic parts of the toilet (lid, seat and outer covering) should be cleaned using water and a mild cleaning agent only.

The inside of the toilet bowl is ceramic and should be cleaned monthly only with the recommended Dometic Bowl and Seal Cleaner, as specified adjacent. This cleans the toilet effectively, without damaging the ceramic liner or seals. Pour the cleaner into the bowl with the ball valve closed and clean the ball valve when closed with a toilet brush.

Then press the foot pedal to open the ball valve. Gently clean the underside of the rubber sealing ring with a brush, so the interface between the sealing ring and ball valve is clean. Then rinse with water.

If you live in a hard water area, use de-scaler periodically to prevent limescale build up on the seal to the ball valve and sealing ring.

Periodically clean the points that transfer waste between the base station and cassette. Push in and hold the outer spring to the waste discharge port shown in the **left photo below**, to reveal the 2 O ring seals. Check that these are undamaged. Remove any waste material, clean and apply silicone grease.

Push in the 2 sprung pistons to the cassette (**right photo below**), remove any waste material, clean and lightly apply silicone grease.

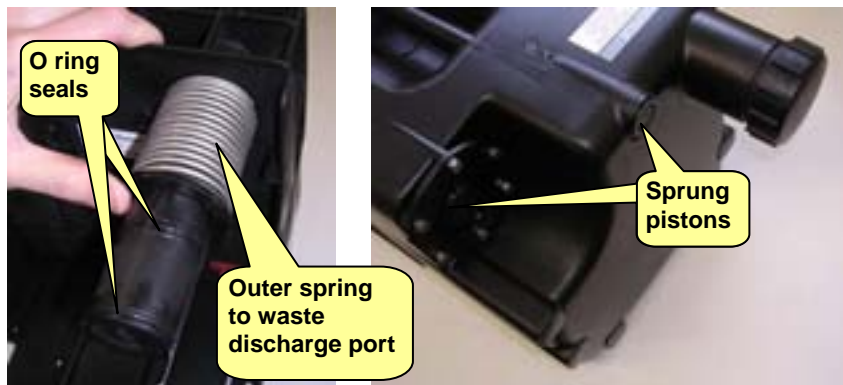

ODOUR FILTER

Periodically remove the odour filter set into the bottom of the base station and check that the two O ring seals are still covered lightly with silicone grease.

The filter in the base station needs to be changed not less than every 3 years, or more often if the toilet is in frequent use. The Dometic part number for the filter is: 242 6001-14/1.

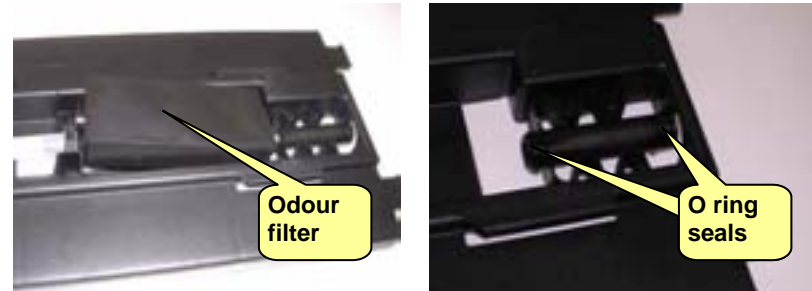

RECOMMENDED PRODUCTS

Toilet paper

Use only quickly dissolving 2 ply/ layer toilet tissue designed for toilets in caravan's/ motorhomes and boats, such as **Thetford Aqua Soft**.

This rapidly dissolving tissue contains less glue, reducing the risk of pipework blockages and aiding emptying of the cassette.



Bowl and seal cleaner

Dometic 'Quality Care' toilet bowl cleaner, 475ml bottle.

Apply without dilution, rinse bowl thoroughly with water after cleaning. Available from your Airstream dealer, or Dometic.

Silicone grease

Dow Corning "High Vacuum Grease", available from your Airstream Dealer.

LOSS OF VACUUM

If the vacuum pump will not shut off, or comes on intermittently, troubleshoot as follows:

Cassette

Cap screwed on firmly. Remove the WC cassette and check whether the screw on cap (which you unscrew to empty the cassette) is firmly screwed on. If it was loosely screwed on, then air would enter here and prevent the vacuum forming.

Cap O ring seal. Un-screw the cap to the cassette and check that the O ring seal in the cap is undamaged. Apply silicone grease.

Then replace the cassette on the base station and turn the toilet vacuum pump isolation switch **(3)** ON to re-charge the vacuum.

Toilet bowl

Seal between ball valve and sealing ring. Turn on the water pump **(8)** at the main electronic control panel. Then lift the flush pedal to the toilet and fill the toilet bowl to about 50mm/ 2" depth of water. If the sealing ring to the ball valve is leaking air, then the water level will slowly drop. Clean the ball valve and underside of the sealing ring of any small pieces of toilet paper, dirt or build up of limescale. Try cleaning with limescale remover using an old tooth brush.

If the water level remains the same in the toilet bowl, but the pump will not shut off, the next thing to do to troubleshoot the base station.

Base station

Turn the toilet vacuum pump isolation switch **(3)** on, so the pump runs. Then remove the cassette.

Apply thin disposable type rubber gloves. Push in the outer spring to the waste discharge port (see photo previous page), revealing 2 O ring seals. Check these seals are clean and free of toilet paper/ detritus. Apply silicone grease.

Then move to the left, to the smaller cylinder port which draws air from the cassette. Place and hold a finger over the small hole in the underside of this cylinder (**left photo next column**), then push in the red button towards the bottom of the back part of the base station (**right photo next column**).

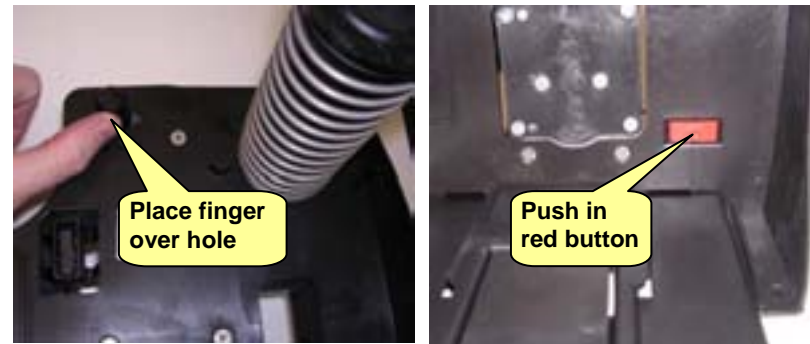

The pump should start, then stop immediately. Remove your finger from the hole in the underside of the small cylinder and you should feel the vacuum released. If so, this points to a problem with the cassette. If the pump stops and starts intermittently, this points to a problem with the pump, or piping.

Piping

To check whether the piping is the cause of air leakage, wear rubber gloves, then take apart the WC piping at a joint as close to the toilet base station as possible.

Put your hand over the open pipe connecting to the base station and feel whether there is suction. Keep your hand there for a minute and see if the vacuum builds and the pump shuts off. If it does, this would then point to a leak in the piping between the base station and toilet bowl.

The piping has an O ring seal at every joint. It is possible that one of the O ring seals is not seated correctly, sometimes they get pushed out of shape or pushed down the pipe during install, or later maintenance (if the piping has been taken apart to remove a blockage).

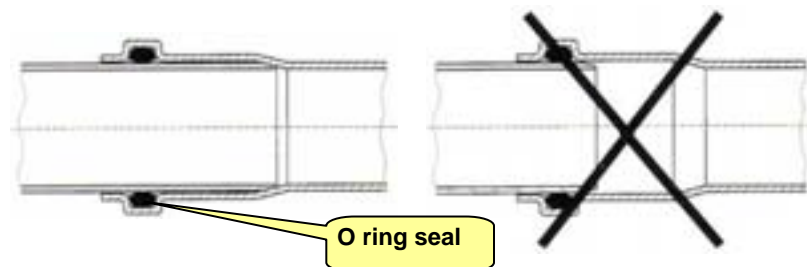

K1 – Vacuum toilet, trouble shooting & putting out of service

BAD ODOURS

Check that the odour filter is correctly fitted and the 2 O ring seals are greased. See photos on previous page under heading 'Odour filter'.

Check that the ventilation hose from the odour filter is properly connected, clear of obstruction and not kinked:

Remove the cassette to reveal the ventilation hose which is a clear plastic pipe, passing from the odour filter down through the floor. Disconnect the ventilation hose from the odour filter. Clean the end and blow through to check if it is unobstructed. Remove the hose and/ or inspect the underside of the Airstream as necessary to identify any possible blockages.

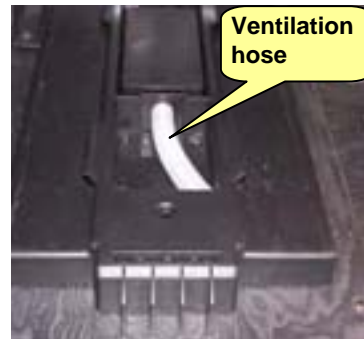

PUMP CLICKING ON AND OFF

Check connections to the printed circuit board are all securely fitted as shown in the photos below.

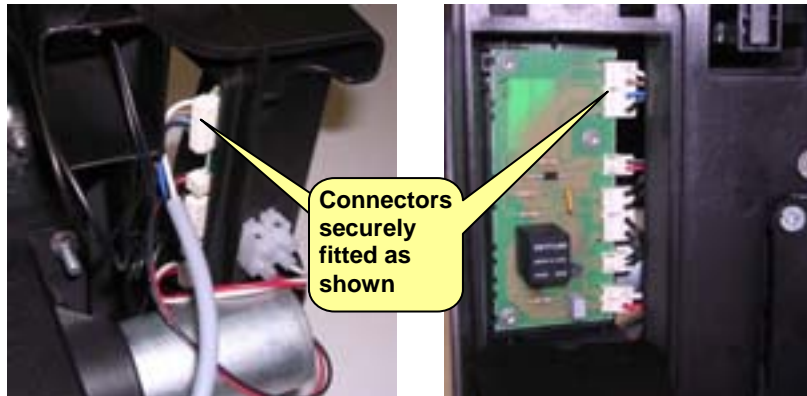

PUTTING OUT OF SERVICE

If the Airstream is not going to be used for a period of time, especially in winter months, proceed as follows:

Turn on the toilet vacuum pump isolation switch **(3)**, so the green LED illuminates on the toilet display panel, indicating the toilet is ready for use.

Turn off the water pump **(8)** at the main electronic control panel.

Press the toilet pedal to flush the toilet, without allowing any water to enter.

Repeat the above step to flush a 2nd time.

They empty, rinse and clean the cassette. If the cassette is to be put back on the base station and left in the Airstream, ensure it is completely empty of fluid. Otherwise it can be stored inside in a heated space.

Turn off the toilet vacuum pump isolation switch **(3)**.

Access the white screw on cap to the water inlet valve, under the toilet pedal. Place a small container underneath to catch water.

Unscrew the white cap (a wrench may be required to loosen it) to let all water drain from the toilet bowl, which may take several minutes. Then screw the white cap back on again.

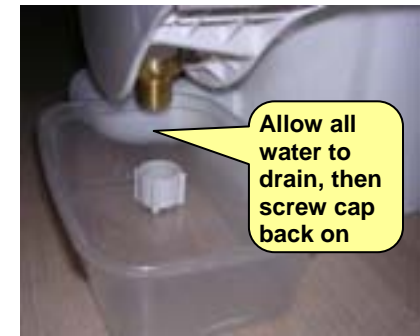

SMOKE ALARM TYPE

A smoke alarm is a requirement in some European countries, so is fitted to some (but not all units). For example, a smoke alarm is required in the UK.

When fitted, the smoke alarm used is of a type approved for use in leisure vehicles.

Refer to the smoke alarm manufacturer's instructions contained in your Owner's pack for full information on the use and features of the smoke alarm, if fitted.

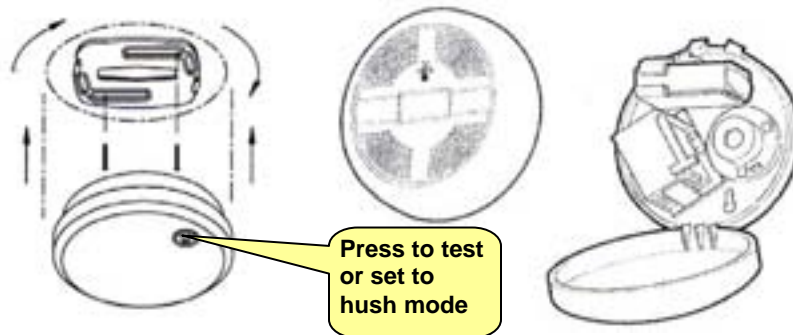

HUSH FEATURE

Models with a hush feature allow nuisance alarms to be silenced, when local conditions may cause false alarms. They operate as follows:

1. To stop a false alarm, press the button on the face of the unit (the same as the test button). The alarm will go into the Hush mode for approximately 10 minutes.
2. At the end of the 10 minute hush period, the alarm will automatically reset itself. If smoke is still present, the alarm will sound again – the button can be pressed again to allow further time for the smoke to clear.
3. While in the Hush mode, the alarm will still be in the detection mode but the sensitivity is decreased. If the density of smoke increases, the unit will automatically by-pass the hush mode and the alarm will sound.
4. After testing, the alarm will go into the Hush mode. The unit will automatically switch to the detecting mode after 10 minutes.

MAINTENANCE & TESTING

The alarm should be dusted/ cleaned regularly with a damp cloth.

Test the smoke alarm before each trip/ not less than monthly or after the Airstream has been in storage for a period.

To test the alarm, press the test button for at least 10 seconds. The alarm signal is a penetrating rapidly pulsating signal.

Under the test button, there is a red control lamp which illuminates once a minute. This shows that the battery is correctly connected.

If the alarm does not sound when testing, the battery must be replaced.

BATTERY REPLACEMENT

The battery last approximately one year.

About a month before the battery is completely flat, the alarm emits a short signal once a minute. This is the signal that the battery needs replacing. The alarm works normally during this time.

To remove the alarm from the ceiling, turn it anti-clockwise so it comes loose from the ceiling mounting bracket.

Remove the existing battery and fit the replacement battery (9volt battery such as Duracell MN1604).

Before re-fixing the alarm to the ceiling, clean the alarm carefully using a vacuum cleaner with soft brush attachment.

Always test the alarm after changing the battery.

K3 - Refrigerator

REFRIGERATOR NORMAL OPERATION

European specification Airstreams are fitted with Dometic absorption refrigerators, which use ammonia as a coolant. The refrigerator operates on either 230v mains electricity, 12v DC electricity, or liquid gas (propane/ butane).

Refer to Dometic's operating instructions contained in your Owner's pack for full explanation of the controls for different refrigerator models and for detailed advice on all aspects of the operation of the refrigerator.

The image below shows the controls for manual energy selection (MES) models.

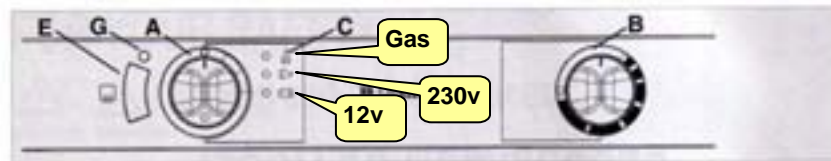

A = energy selection switch
B = gas/electric thermostat AC/DC
C = operating displays (3 LEDs)
E = switch for frame heating
G = display LED for frame heating

If you store the Airstream at home, switch the refrigerator on at least 12 hours before you depart, with the energy selector switch to 230v, so the refrigerator is pre-cooled. Then place pre-cooled food and drink in the refrigerator when packing to depart.

Set the fridge to the 12v energy option just before travel. The adjacent LED will light green only once the car ignition is turned on, so long as the Airstream and car are correctly electrically connected, so pin 10 of the 13pin connector is powered when the car is running (see Section F11 of this manual for full details).

NOTE! Powering the refrigerator on 12v DC from the towcar battery is suitable only for maintaining the temperature of the refrigerator and its contents once it has been refrigerated.

! CAUTION. Shut and lock the refrigerator doors before travelling.

On arrival at the campsite, check the mains electricity supply available in amps. If the supply is limited (5 amps or less), or there is no mains electricity available, set the fridge to gas operation.

Otherwise, set the energy selector switch to 230v mains electricity.

GAS OPERATION

Refer to Section H5 of this manual for advice on troubleshooting fridge operation on gas.

If the refrigerator is operated when travelling using gas, the precautions stated by the legislation in the respective country must be taken (in conformity with the European standard EN 732).

Do not use the refrigerator on gas operation in petrol stations.

Due to physical reasons, ignition faults could occur starting from an altitude above sea level of approx. 1000m/ 3280 ft.

The refrigerator should only be operated using liquid gas (propane or butane), do not use Autogas, town gas or natural gas.

GENERAL ADVICE

- Switch the refrigerator on about 12 hours before filling it.
- When possible, pre-cool items to be stored, i.e. store them in your home refrigerator before placing them in the refrigerator in the Airstream.
- Allow foods that have been warmed up to cool before storing.
- Store quickly perishable foods directly next to the cooling fins.
- The refrigerator is not suitable for the proper storage of medications.

Frost builds up on the cooling fins when the fridge is in use. If the layer of frost reaches 3mm thickness, the refrigerator should be switched off and defrosted. Do not forcibly remove ice, or accelerate defrosting using heat.

FREEZER COMPARTMENT

The freezer compartment is suitable for making ice cubes and for short-term storage of frozen food. It is not suitable as a means of freezing foods.

Ice cubes are best frozen overnight. At night, the refrigerator has less work to do and the unit has more reserves.

When ambient temperatures are lower than + 10 degrees centigrade, an even regulation of freezer temperature cannot be guaranteed, if the refrigerator is exposed to these temperatures for a long period of time. This can cause the temperature in the freezer to rise and the stored goods to de-frost.

FRAME HEATING

Some models are equipped with frame heating around the freezer compartment.

During summer months with high temperatures and humidity, water droplets may form on the metal frame. To evaporate these droplets, switch on the frame heating with switch **(E)**. The LED **(G)** indicates that the frame heating is on.

The frame heating will draw 12v DC constantly @ 0.3amps. Observe the LED (G) and turn off the frame heating if it is not required.

VENTILATION GRILLES

When washing the exterior of the Airstream, do not direct high pressure water at the ventilation grilles, as this will cause water to enter the interior.

When the ambient external temperature falls below +8 centigrade, the optional winter covers (**photo below**) should be fitted to the ventilation grilles. This protects the fridge from excessively cold air.



STORAGE

If you will not be using the refrigerator for a period of time, for example if the Airstream is in storage, carry out the following actions:

- Remove all food
- Switch off the refrigerator
- Clean the refrigerator
- Shut off the gas manifold tap serving the refrigerator
- Leave the door(s) of the refrigerator ajar, using the ajar door closure position of the refrigerator door lock.
- Fit the winter covers to the external ventilation grilles.

MAINTENANCE & SAFETY ADVICE

Keep the refrigerator clean and defrost the refrigerator as often as is necessary.

Check periodically that the refrigerator door(s) close properly, or ice will form in the refrigerator. Close with door with a piece of paper between the door and body of the refrigerator. Pull at the piece of paper. If you feel resistance, the door closes properly. Repeat on the other 3 sides of the refrigerator door.

In the event of leakage of ammonia (easily identifiable from the unpleasant odour) switch off the appliance, open windows and contact your dealer.

The gas burner to the refrigerator must be cleaned at least once a year, this is normally done during the annual service.

! WARNING Work on the gas, flue system and electrical components must only be carried out by qualified service personnel.

K4 – Cooker, Spinflo Triplex mk3

SPINFLO TRIPLEX COOKER NORMAL OPERATION

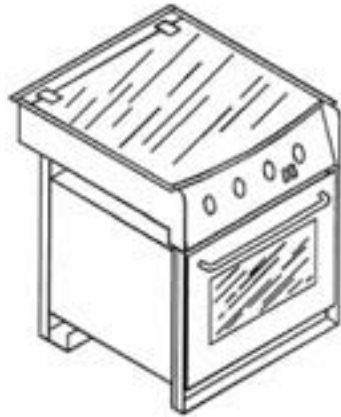

The Triplex cooker has 3 x LPG hotplate burners, plus a combined oven and grill.

Before using the appliance for the first time, remove all accessories and packing in the grill and oven, including any surface protection film, i.e. plastic coating.

The control tap on this appliance operates both the Grill and Oven burners. To ensure safe operation it is not possible to operate both burners at the same time.

The oven/ grille pan supplied with the appliance has a removable handle. Always remove the handle when the pan is in use.

The oven shelf is fitted with a raised bar to prevent trays or dishes making contact with the back of the oven.

VENTILATION

The use of a gas cooking appliance results in the production of heat and moisture in a room in which it is installed. Ensure that the kitchen area is well ventilated - turn on mechanical ventilation (extractor hood or ceiling exhaust fan) and during prolonged use, open a window to increase ventilation.

GLASS LID

Glass lids may shatter when heated. Turn off the hotplate and allow it to cool before closing the glass lid.

GRILL

The grill **MUST** only be used with the door open.

The heat deflector below the fascia should be pulled out prior to lighting the grill. Never adjust the heat deflector position without using hand protection – i.e. oven gloves.

OVEN TEMPERATURE CONTROL

The temperature in the oven is controlled by a thermostatic gas tap and is variable over the range 130°C to 240°C. Approximate temperatures for the settings on the control knob are shown in the table below. The temperatures indicated refer to the centre of the oven and at any particular setting the oven will be hotter at the top and cooler towards the base. The variation between top and centre, and centre to bottom is approximately equivalent to one gas mark.

Gas Mark	Temperature			
¼ - ½	265-275°F	130-135°C	Very cool	Meringues
1	285	140	Cool	Stewed fruit
2	300	150	Cool	Rich fruit cake
3	330	165	Warm	Baked custard
4	355	180	Moderate	Victoria sandwich
5	385	195	Fairly hot	Whisked sponges
6	410	210	Hot	Short crust pastry
7	430	220	Hot	Bread, scones
8	445	230	Very hot	Puff pastry
9	465	240	Very hot	Quick browning

DO'S AND DON'TS

- DO read the user instructions carefully before using the appliance.
- DO allow the oven to heat before using for the first time..
- DO clean the appliance regularly.
- DO remove spills as soon as they occur, clean with warm soapy water.
- DO always use oven gloves when removing food shelves and trays from the oven.
- DO check that controls are in the off position when finished.

- **DO NOT** allow children near the cooker when in use. Turn pan handles away from the front so that they cannot be caught accidentally.
- **DO NOT** allow fats or oils to build up in the oven trays or base.
- **DO NOT** use abrasive cleaners or powders that will scratch the surfaces of the appliance.
- **DO NOT** under any circumstances use the oven as a space heater.
- **DO NOT** put heavy objects onto open grill and oven doors.

Refer to Spinflo's operating instructions contained in your Owner's pack for detailed advice on all aspects of the operation of the appliance.

K4 – Cooker, Spinflo Triplex mk3

Spinflo Triplex exploded parts drawing:

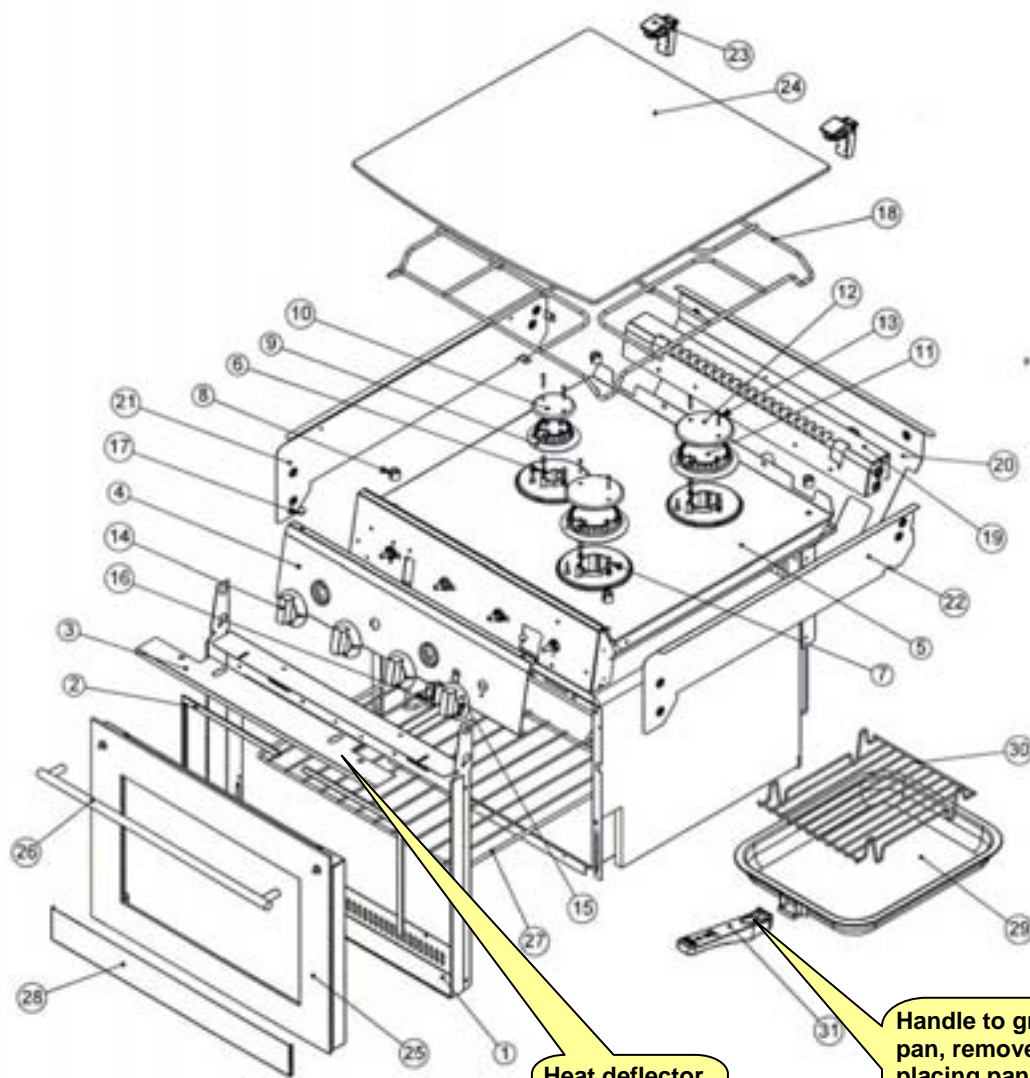

Heat deflector, pull out before using grill

Handle to grill/ oven pan, remove when placing pan in oven/ under grille, or it will melt

ITEM NO.	PART NUMBER	DESCRIPTION	QTY.
1	MCO3583.BK	TRIM, FRONT, TRIPLEX 445 SAFE BK	1
2	PCO0246	SEAL, OVEN DOOR MK3 FRONT FLUE	2
3	MCO3664.BK	HEAT DEFLECTOR, FASCIA, MPR445 BK	1
4	MCO3543.BSP	BEVEL FASCIA, TRIPLEX 445 1/20, OGR BSP	1
5	MCP3851.BS	HOB PANEL, TRI 445 1/20 BS LH	1
6	PCX0339	WASHER, 4BA RED FIBRE	6
7	PCC0814	STUD, FIXED BNR CAP, 0656	6
8	PCC0847	CLIP, PAN SUPPORT PTFE TOP FIX	4
9	PCC0824	BURNER SPREAD, SR2, ALUX 0925/3	1
10	PCC0825	BURNER CAP, DRILLED, ALUX 0880/3	1
11	PCC0812	BURNER SPREAD, SR2, 1263/3/01	2
12	PCC0813	BURNER CAP, DRILLED, 0881/3.1	2
13	PCC0815	SCREW, FIXED BURNER CAP, 0371	6
14	PCC0590.SA	KNOB, HOB/GRILL, 2 PIECE, SA/BK	3
15	PCC0595.SA	KNOB, OVEN, 2 PIECE, SA/BK	1
16	PCC1340	SWITCH, ROCKER, RECT, BLK, SPARK	1
17	PCX0389	BUMP STOP, PUSH FIT, DIA 9.5x4.0	2
18	PCC0884	SUPPORT, PAN 3 (TR) TRIPLEX 445 CHROME	1
19	MCO3569.BK	TRIM, REAR, HOB, SLIMLINE HINGES TRI 445	1
20	MCO3566.BK	TRIM, HOB, BACK, TRIPLEX 445	1
21	MCO3787.BK	TRIM, HOB, L/H SIDE, CAP/MIN/TRI, R12.8 PROFILE	1
22	MCO3786.BK	TRIM, HOB, R/H SIDE, CAP/MIN/TRI, R12.8 PROFILE	1
23	PCC2003.BK	HINGE, GLASS LID, 2004 STYLE	2
24	G995.BK	GLASS, LID TRIPLEX 445 MK3, BK/GR	1
25	MAD3435.BK5	OVEN DOOR, MPR445 D BK 5S3 BSOC	1
26	PCO0308.S	HANDLE, T BAR, 12MM SS 390 CRS	1
27	PCO0293	SHELF, OVEN / GRILL (DUPLEX)	1
28	AC0710	CLADDING, VS 434x50x4MM, OVEN, BTM, BS	1
29	MAC0066	GRILL PAN ASSEMBLY, LONG	1
30	PCC1195	TRIVET, GRILL PAN	1
31	PCC1186	HANDLE, DETACHABLE, GRILL PAN	1

ALSO INCLUDED BUT NOT DRAWN:-
PCC1265 - INSTRUCTIONS, USER TRI445 UK

K5 – Tracker, overview

Phantom tracker system components:

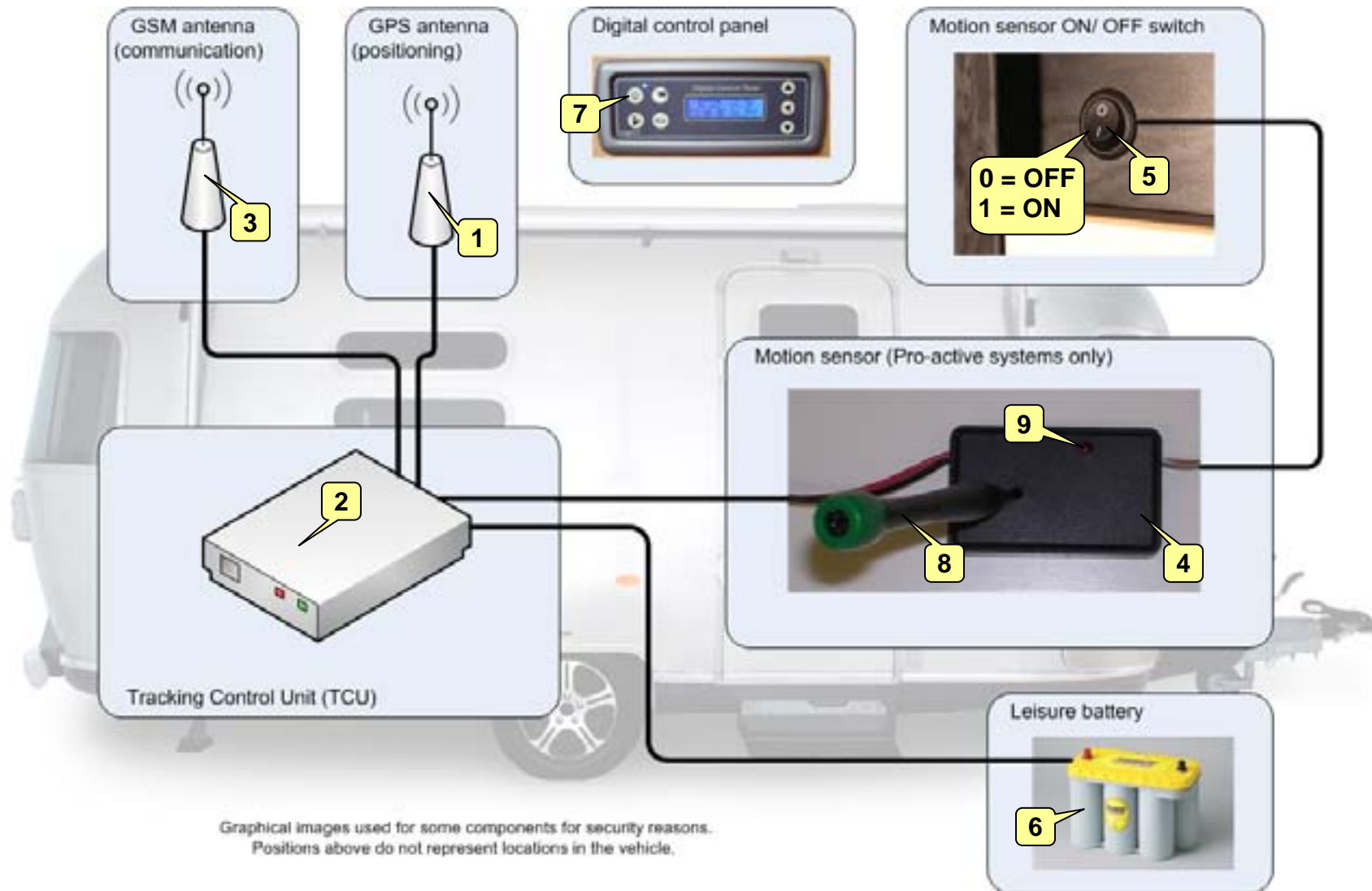

PHANTOM TRACKING SYSTEM EXPLAINED

A satellite tracking system allows tracking/ location of vehicles in the event of theft.

The Phantom Tracking System is available to Airstream customers in the UK and other European countries as optional equipment. It uses GPS technology for positioning and GSM technology for communication.

The standard entry level installation (Phantom Target) is triggered by the user – if the vehicle is stolen, the user calls the Phantom monitoring station, who then activate the tracker unit to check the location via the GPS antenna.

The superior Phantom Pro-active system is triggered by a motion sensor (or alarm), which triggers the tracker unit if the vehicle is moved.

All European Airstreams have a GPS antenna **(1)** pre-installed in a discrete location. When/ if you decide to have the tracker fitted, your Airstream dealer installs the Tracking Control Unit **(2)**, GSM antenna **(3)**, motion sensor **(4)** and motion sensor ON/ OFF switch **(5)**. Ask your dealer to show you the location of all the components after installation.

You can choose either a 1 year subscription, or 5 year subscription for the ongoing monitoring service.

NORMAL OPERATION

Turn the motion sensor ON/ OFF switch **(5)** to the ON position when you leave the Airstream unattended and want the Tracker to be ready to trigger.

Remember when hitching up and towing the Airstream away, to turn the motion sensor ON/ OFF switch to the OFF position. **0 = OFF. 1 = ON.**

LEISURE BATTERY

The Tracking Control Unit **(2)** is powered by the Leisure battery **(6)** in the Airstream, which must therefore remain connected and adequately charged, or the Phantom tracker will not operate. Whilst there is a small backup battery within the TCU, this will only provide power for approx 24hrs.

When the Airstream is in storage, ensure the leisure battery voltage remains adequate (not less than circa 9v). If a 230v mains supply is not available where you are storing the Airstream, consider installing a solar panel to keep the leisure battery adequately charged for the tracker to operate.

Disconnecting the leisure battery for any reason will trigger the unit. Always call the Phantom Control Centre before and after disconnecting or re-connecting the leisure battery or removing the 20amp leisure battery fuse(s), to reduce the number of false alarms on your account.

The tracker is wired to the permanent live feed of the Airstream's Power Supply Unit, so it will receive power even when the Digital control panel is turned off **(7)** when you leave the Airstream.

6 WEEKLY SCHEDULED TEST

Every 6 weeks the Phantom monitoring station automatically checks communication with the TCU. If no response is obtained it will try again 3 days later, then try again 4 days after that.

If no response is obtained to the 6 weekly scheduled test, for example due to lack of power to the TCU (because the Airstream's leisure battery is not charged), this will trigger a text/ call to the customer. This is confirmed in writing by e-mail or letter stating that the unit has failed its last scheduled test. The customer is asked to check the unit and contact Phantom's technical department.

MOTION SENSOR

The motion sensor ON/ OFF switch **(5)** arms and disarms the motion sensor **(4)**, not the whole Tracking Control Unit **(2)**. In a worst case scenario if the user forgets to switch the motion sensor on and returns to find their Airstream missing, Phantom can still track the Airstream once alerted to the theft.

The sensitivity of the motion sensor can be adjusted by inserting a small watch maker's screwdriver into the hole in the motion sensor **(8)**. Turn clockwise to increase the sensitivity and anti-clockwise to decrease the sensitivity.

Test the sensitivity. Turn on the motion sensor ON/ OFF switch **(5)**. Expose the motion sensor. Ask someone to close the entrance door to the Airstream, whilst you are watching the motion sensor. The small red LED **(9)** on the motion sensor will illuminate when the motion sensor triggers.

Turn the sensitivity down so the entrance door can be closed without triggering the motion sensor.

Then tow the Airstream a short distance to confirm that the tracker is still sufficiently sensitive to be triggered by normal towing.

K5 – Tracker, information

DEVICE NUMBER

Keep a note of the Phantom device number with you at all times. This is recorded by the installation engineer on the Phantom Registration Certificate.

You will need to quote this device number if you call the Phantom control centre.

WHAT TO DO IF YOUR AIRSTREAM IS STOLEN

Make 3 phone calls:

1. Telephone the Police and report the theft. They will provide you with a crime reference number or log number – usually numbers with that days date as the final reference.
2. Telephone the Phantom 24 hour control centre on +44 (0)845 458 0888. They will ask for both your device number and your crime reference. The location procedure will then proceed and Phantom will liaise with the Police to secure and recover the Airstream.
3. Telephone your insurance company to advise them of the theft and that you have a Phantom tracker fitted.

SET UP TEXT ALERT

Call the Phantom call centre to set up a 4 digit PIN on your account, so you can respond to text alerts.

Text alerts are sent by the call centre, before a telephone call is made, alerting a customer to movement of their Airstream.

If the customer replies by entering their 4 digit pin using their nominated mobile, the alert is tagged as a false alarm and no follow up call is made.

PHANTOM CONTACT DETAILS

24 hour call centre for tracking emergencies:

+ 44 (0)845 458 0888

Other technical or operational enquiries – call Phantom head office on:
+ 44 (0)8451 303 301

COVERAGE & LIMITATIONS

The Phantom system operates in mainland UK, Northern and Southern Ireland, across Europe and into Asia, limited only by the mobile phone network.

Coverage is limited by the network of the telecom service provider that Phantom use, which is generally Vodafone. If from time to time the Airstream is in an area of poor mobile telecom signal strength, this will prevent/ affect communication between the GSM antenna in the Airstream and the monitoring station.

Similarly, if the Airstream is positioned within a building or enclosure that prevents the GPS antenna seeing the satellite, the Phantom control centre will not be able to give a current position (but will show a last recorded position).

TRAVEL OUTSIDE THE UK

Phantom request that UK customers inform the call centre before travelling in Europe or outside the UK. There is no additional cost for this.

Phantom manage communication costs by setting a credit limit on each number, beyond which the unit cannot pass. When customers travel abroad the costs of communication increase and units may hit this limit sooner. By informing Phantom before travelling abroad, customers allow Phantom to manage their account to ensure the credit limit is not exceeded.

Phantom don't currently charge extra for their European coverage, they can locate the vehicle, but don't liaise specifically with the local police force. They can provide the customer with accurate positions and assist where possible. A fuller liaison service may be available as an add on option in the future.

SUBSCRIPTION RENEWAL/ UPDATE CONTACT DETAILS

Access your Phantom account on-line at www.phantom.uk.net, to update your contact details, or renew your subscription.

Refer to Phantom's operating instructions and terms and conditions of use in their literature contained in your Owner's pack.

AIR CONDITIONER MODEL TYPE

When choosing an air conditioner, the exterior size and appearance of the roof mounted models available from Dometic in Europe is very similar.

Refer to Dometic's operating instructions contained in your Owner's pack for full explanation of the controls for different refrigerator models and for detailed advice on all aspects of the operation of the refrigerator.

The models differ in their cooling capacity, size of heat strip incorporated & type of internal diffuser. The usual models offered by Airstream dealers are:

	B1500 S	B1600	B2200
Flush 1 way diffuser	Yes	No	No
2 way diffuser	No	Yes	
Cooling capacity	1.5kW	1.5kW	2.05kW
Electrical draw (max)	2.9amps	2.9amps	4amps
Heating element	0.8kW	0.8kW	1.2kW

Thus the main difference between the B1500 S and the B1600 is the latter has the 2 way diffuser (**right image below**).



B1500 S

Internal diffuser blows to front only, flush with ceiling (better headroom)



B1600 & B2200

Internal diffuser blows front and/ or rear, projects 50mm below ceiling

NORMAL OPERATION

230v AC power is required to operate the air conditioner. Connect the mains hook up cable to the Airstream and verify that the fused switch labeled 'Aircon' is on (labelled '8' on schematic in Section F1 of this manual) so the LED is lit.

B2200. Turn on the air conditioner using the power button on the diffuser, so the adjacent LED illuminates orange (standby mode). Then press the power button on the remote control, the LED should turn green and the unit will start.

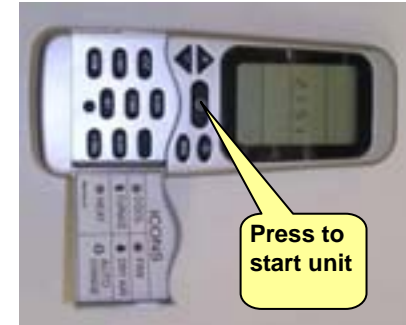
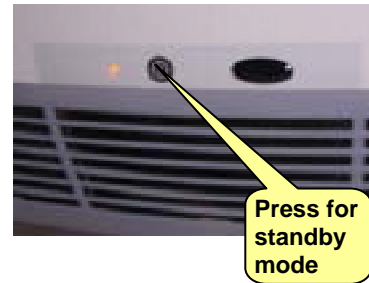

The B2200 diffuser incorporates 4 x LED lights, which are turned on by pressing the 'LIGHT' button on the remote control.

B1500. Press in the ON/ OFF switch on the diffuser, then press on the Warm/Cold switch – the in position is for cooling.

Then adjust the desired temperature using the thermostat control on the diffuser (B1500 S) or UP/ DOWN buttons on the remote control (B1600 and B2200). The minimum temperature that can be set is 16 Celsius (B2200) or 18 Celsius (B1500 S).

HEAT MODE

All the models incorporate a heat strip, however this is of limited size (0.8kW or 1.2kW) and will provide a degree of warming only (by comparison the Alde heating provides up to 5.5kW).

To operate the heat strip, select the head mode for the air conditioner, then set the fan speed to the lowest speed. Setting the fan speed higher blows air too quickly – before the heat strip is able to heat the air.

K6 – Air conditioner

ADJUSTING THE AIR FLOW DIRECTION

B1500 S – pull down the front facing flap of the diffuser:

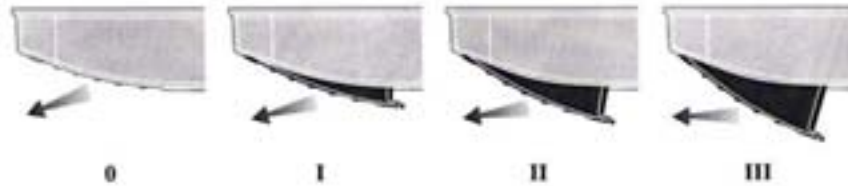

B2200 – loosen the centre knob, then slide the knob front or rear:



DO'S AND DON'TS

- DO read the user instructions carefully before using the appliance.
- DO close doors and windows before turning on the air conditioner.
- DO wait some minutes (at least 3) before attempting to turn the air conditioner on, after turning it off, to prevent damage to the compressor.
- **DO NOT** spray the air conditioner with water when cleaning the vehicle.
- **DO NOT** put your hands or other objects into the openings.

CLEANING & MAINTENANCE

1. Periodically clean the air conditioner external housing and internal diffuser with a damp cloth, with mild detergent to remove any stains.
2. Periodically clean the filters to the internal diffuser to prevent a build up of dust. *Refer to the larger illustrations for removing filters in Dometic's Operational Manual.*

B2200 filter removal:



B1500 S filter removal:



3. Periodically inspect the condensate drain holes in the external housing (**below**), to ensure these are clear of debris, so condensate water can drip onto the roof of the Airstream.

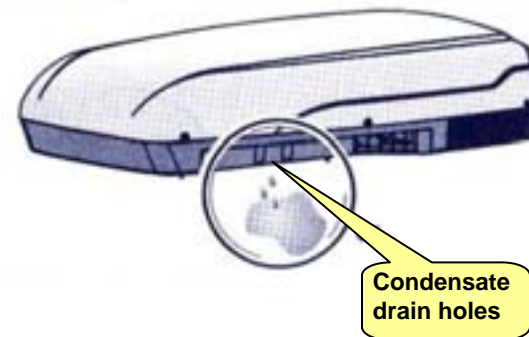

MOVER DESCRIPTION

A mover device uses 12v DC electric drive units clamped to the Airstream chassis to drive the wheels of the Airstream, allowing the Airstream to be moved by remote control when not coupled to the tow car.

This allows easier and potentially safer manoeuvring on small sites/ campgrounds.

The movers made by Reich are considered more suitable (than other makes of mover) for the Airstream European products, because Reich offer systems with 4 drive units for twin axle trailers. This gives better performance for heavier twin axle trailers, than having only 2 drive units.

Single axle Airstreams use the MoveControl with 2 drive units. These can be fitted either in front of, or behind the wheels.



MoveControl Comfort



MoveControl Comfort Twin 4WD

INSTALLATION

Installation of a mover is best carried out by a technician experienced in installation of Reich products. The installer is responsible for correct installation, both mechanical and electrical.

NOTE: The mover electronics (the E-box) are connected directly to the leisure battery of the Airstream by 10sqmm cables. If the Airstream has the EC325 Power Supply Unit fitted, the voltage at the battery terminals may be higher than 12v during charging, if the battery(ies) were deeply discharged.

As these higher voltages could damage the 12v motors of the mover, it is important to disconnect the 230v supply from the Airstream before using the mover.

MOVE CONTROL COMFORT

The MoveControl Compact has the drive motors separate from the spindle housing. The drive motors are positioned inboard of the chassis rails (**left image below**).

Customers not opting for the Motor Drive option, manually wind the spindles on and off the tyres, using the 19mm hex bolt that projects out of the motor drive housing.

For more convenience, choose the optional Motor Drive (**right photo**), which uses additional motor(s) to automatically wind the spindles onto the tyres.

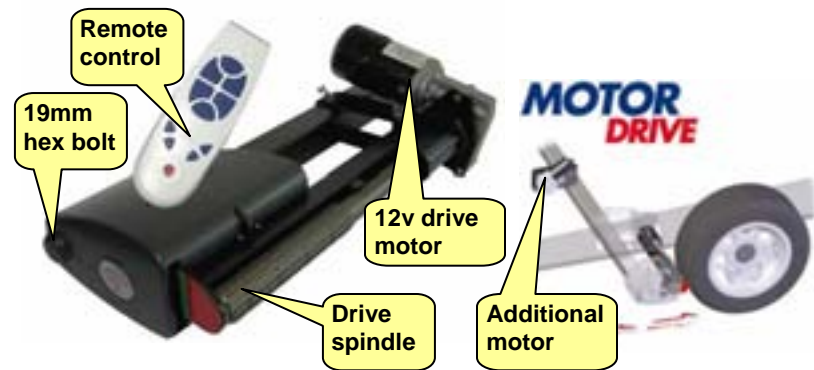

MOVE CONTROL COMPACT

A new variant, the MoveControl Compact combines the drive motor and spindle engagement motor into one housing, fitted outboard of the chassis rail.



Note: The housing of the compact version will sit higher relative to the wheel.

This will require part of the Airstream bellypan to be cut away and may require outriggers to be moved, before the MoveControl Compact can be fitted.

K7 – Mover, Reich MoveControl

NORMAL OPERATION, step by step

Refer to Reich's operating instructions contained in your Owner's pack for full explanation of the controls and for detailed advice on the mover operation.

1. Disconnect the mains 230v supply before using mover, by unplugging the orange hook up lead from the side of the Airstream.

! CAUTION. Always un-plug the 230v mains supply lead from the Airstream before using the mover device.

2. Insert the red isolation switch key and turn to the ON position (vertical)

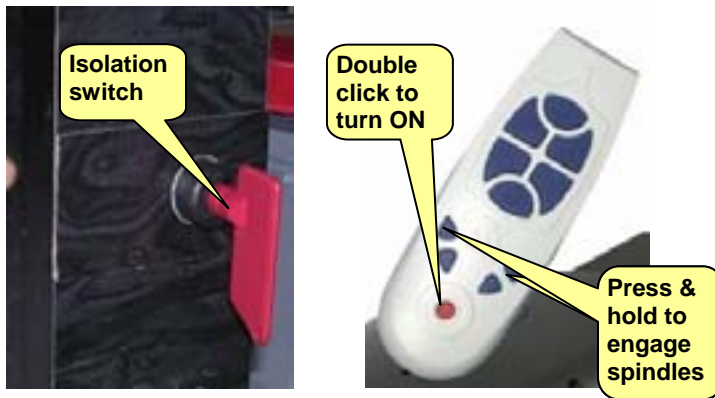

3. Double click the red button on the remote control, which will illuminate red when the remote control is activated.
4. Press & hold the upper pair of spindle control buttons (with the arrows pointing forward). Keep the buttons depressed. The spindles will move towards the tyres and stop once the correct pressure is reached.

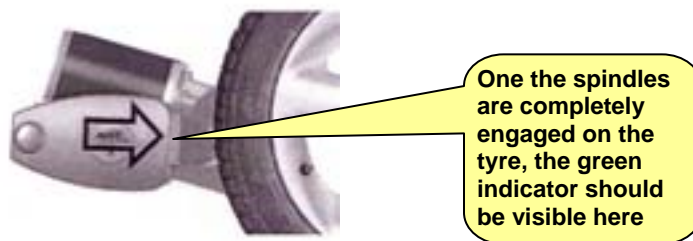

5. Check that the spindle drives are free of dirt, sand, gravel or other debris. Remove any sharp edged stones from the tyres.

! CAUTION Inspect carefully for small stones trapped in the tread of the tyres, particularly when parked on gravel surfaces.

6. Disengage the Airstream's handbrake.

! CAUTION Only disengage the handbrake once the mover spindles are engaged on the tyres, or the Airstream will move if parked on a slope.

7. Use the forward/ back/ rotate buttons to move the Airstream. Ensure you have visibility between the Airstream and objects it is moving towards.

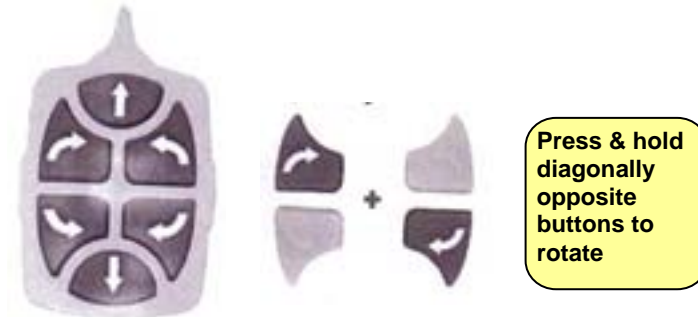

8. When you are finished moving the Airstream, apply the parking handbrake, so the handbrake lever is in the vertical position.
9. **Once the parking handbrake is applied**, you can take the mover spindles off the tyres. Wind them off manually, or press and hold the lower pair of spindle control buttons until the spindles are fully retracted. Then turn off the red isolation switch key.

! CAUTION. Before towing the Airstream, check that the mover spindles are fully retracted, so the red indicator is not visible.

! CAUTION. The drive casing projects close to the edge of the tyre. Be careful not to park too close to raised kerbs, if the drive casing is hit this risks damage.

OPERATION WITH CABLE

If you experience radio interference, or the batteries of the remote control are exhausted, you can connect the remote control and E-box with the cable. The cable is contained in the Reich folder.

Open the battery compartment of the remote control to locate the cable plug in point. The cable plug in point on the E-box is on the outside of the E-box casing.

MAINTENANCE

The following checks should be carried out at least once a year and are best undertaken by a technician during the Airstream's annual service:

- Remove mover drive casing
- Clean all moving parts
- Check threads at the spindles are free of obstruction and damage
- Apply lubricant (silicone spray) to spindle threads and all moving parts
- Inspect electrical cables and connections for damage. Secure any loose cables.
- Check all bolt connections fixing mover to chassis are sound and tight
- Check tyre pressure
- Check distance between spindles & tyres (this should be 15-20mm)
- Supply new batteries to remote control

RESET

The MoveControl is equipped with electrical overload protection and automatically switches off in the case of overload.

If the mover is non responsive, check if the LED of the E-box is illuminated (see adjacent photo), if it is this, this indicates that the overload protector has triggered.

Carry out the following reset procedure:

1. Turn ON the remote control, by double clicking on the red button.
2. Press the reset button on the E-box, following which the LED on the E-box should turn off.
3. Turn OFF the remote control, by pressing the red button once.

SYNCHRONIZATION

A synchronization procedure is sometimes required, after exchange of an electronic part (for example a new remote control handset or E-box) or a malfunction.

Proceed as follows and avoid pauses of more than 2 seconds:

1. If necessary turn OFF the remote control, press the red button once so it is not illuminated.
2. Turn the mover red isolation switch ON.
3. Press and hold the reset button on the E-box. On twin axle units which have two E-boxes, press the reset button on the E-box with the antenna (this is the Master, the 2nd is the Slave).

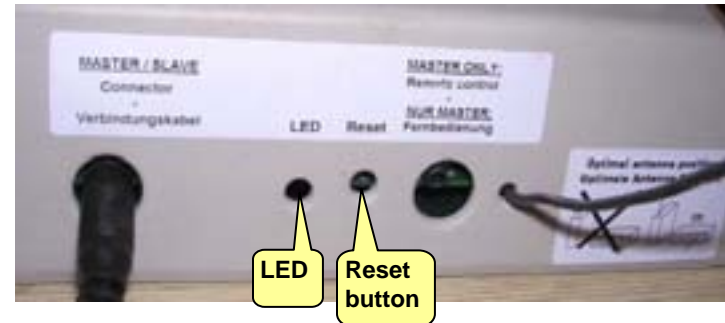

4. Turn the remote control ON, by double clicking on the red button. Both this red button and the LED on the E-box should now be illuminated.
5. Turn the remote control OFF, by pressing the red button once. The red button on the remote control and the LED on the E-box should now be turned off.
6. Release the reset button on the E-box.



Section L – Awnings







Zipdee patio awning

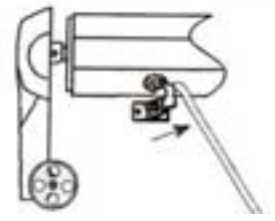

L1

L1 – Zipdee patio awning, opening

OPENING THE AWNING



Follow the step by step instructions below and with a little practice, you will find it quick and easy to single handedly erect and stow the Zipdee awning.



<p>1. Open the travel latch. You can stand on some portable steps..</p> <p>Or use the pull rod provided – insert the pull rod into the travel latch loop and rotate to open.</p>	
<p>2. Release the clamp wheels (if present, one at each end). Turn the clamp wheel anti clockwise and swing the wheel assembly toward the centre of the trailer, to free the hardware.</p>	
<p>3. Unroll fabric. Insert the pull rod into the loop of the centre strap and pull towards you, to unroll the awning.</p>	
<p>4. Walk to one end. Step under the awning, fold the centre strap and tuck it into the loop. This will stop the awning rolling back up as you walk to one end.</p> <p>Alternatively, place your hand on the back side of the roller as you walk to one end.</p>	

<p>5. Extend rafter arm. Lift the claw of the rafter arm off the stud on the main arm bar. <i>Do not let go of the rafter arm tube assembly, or it will drop onto the ground.</i></p> <p>Roll the roller out slightly with one hand as you lift the rafter arm and place the claw over the shaft of the roller.</p> <p>Repeat at the other end.</p>	
<p>The awning is now in the 'half out' position. Use this position if there is some wind, or a risk of wind developing. In this position, the main arm bars are protected being fully inside the main arm tubes.</p>	
<p>6. Extend and lock rafter arm. Step out from under the awning, so you are facing the Airstream. Grasp the head casting at one end and pull towards you to extend the awning.</p> <p>When the roller is fully extended, lean back (see photo) pulling on the rafter arm until the ratchet stud engages (listen for click).</p> <p>Repeat at the other end.</p>	
<p>The awning is now in the 'run off' position. Use this position after washing the awning, or after rain before you stow the awning, to allow water to run off.</p>	
<p>7. Raise roller. Finally, raise the awning to the desired height. Step back under the awning, bend at the knee and with a straightened arm place your hand on the underside of the roller.</p> <p>With your other hand, release the snap stud on the main arm, then straighten your knees to stand up. Release the snap stud into one of the holes in the main arm bar (up to 3 holes of the main arm bar can be exposed).</p> <p>Repeat at the other end.</p>	

CLOSING THE AWNING

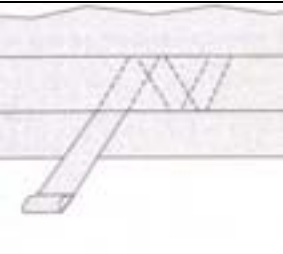
To close the awning, follow the instructions below.

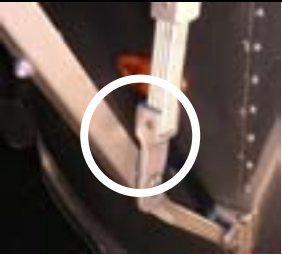
<p><u>1. Lower the roller.</u></p> <p>Release the snap stud of the main arm and lower the roller to its lowest position.</p> <p>Repeat at the other end. You are now back to the 'run off' position.</p>	
<p><u>2. Release ratchet studs of rafter arms.</u></p> <p>Place one hand on the outer tube of the rafter arm close to the ratchet stud. With the other hand, pull downward on the ratchet stud to release it.</p> <p>Repeat at the other end. The awning will roll in. You are now back to the 'half out' position.</p>	
<p><u>3. Lower and store rafter arms.</u></p> <p>Lift the claw of the rafter arm off the roller shaft and place the claw on the height adjustment stud located on the inside of the main arm.</p> <p>Repeat at the other end. As you do so, place your hand on the back side of the roller and walk to the middle of the awning.</p>	
<p><u>4. Half close the roller.</u></p> <p>Un-roll the centre strap if it is rolled up. Hold the end of the centre strap and move from left to right as the awning rolls up, so the strap does not all gather in the same place.</p>	

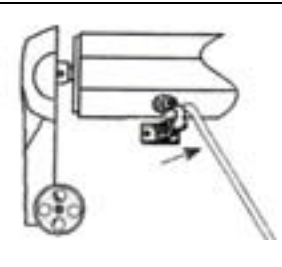
<p><u>5. Rear clawbar clearance.</u> As you close the awning, watch that the claw of the rear rafter arm does not touch and snag on the rear main arm bar.</p> <p>There is less clearance here, than between the claw of the front rafter arm and front main arm bar, due to the way the claw casting is made.</p>	
<p><u>6. Fully close the roller.</u> When all but the last 150mm/ 6" of the awning fabric has been rolled up, release the strap and let the roller spring tension close the awning.</p>	
<p><u>7. Lock wheel clamp.</u></p> <p>Swing the clamp wheel assembly (is present) toward the hardware and fit into place. Then turn the clamp wheel clockwise to tighten.</p> <p><i>TIP: If your awning does not have wheel clamps, ask your Airstream dealer for Zipdee 'Zip straps', for strapping the rafter arm to the main arm when travelling. Sold as a set of 2.</i></p>	
<p><u>8. Lock travel latch.</u></p> <p>Insert the pull rod into the travel latch loop and twist shut.</p>	

Your Airstream dealer will demonstrate the Zipdee awning opening and closing procedure at the handover. If you need another demonstration later, just ask!

L1 – Zipdee patio awning, maintenance

STORM PRECAUTIONS

Please take precautions to prevent damage from occurring due to wind, rain or storm.

If you are leaving the Airstream un-attended, or retiring for the night, close the awning.

If for some reason you can't close the awning fully, lower both ends of it – so the awning is in the '**run off**' position described in the previous pages. This will create a sufficient slope for water run-off and the main arm bars (which can bend) are fully retracted back into the main arm bar tubes. Water weighs 1kg per litre and your awning was not designed to take the weight of water than could accumulate.

MAINTENANCE

At the end of each trip, open the awning fully, both to ensure the fabric is cleaned and dry before being rolled and stored (see fabric care instructions below) and to clean and lubricate the telescopic arms.

Extend all telescopic arms as far as possible, then wipe off accumulated sand and dirt that can clog and scratch the protective aluminium finish and hinder free movement.

Lubricate the main arm bars with Spray Silicone, available in cans from most auto parts stores.

Tighten any loose bolts or screws that you notice, for example:

- Travel latch – if this becomes loose, loosen the holding screw, apply lockite adhesive and re-tighten the holding screw.

Inspect the claws at the end of the rafter arms closely for any fractures in the alloy castings.

Clean the aluminium parts not less than annually with a quality non abrasive chrome or aluminium polish.

Check the fabric for punctures, small tears or stains. Contact your Airstream dealer if your awning fabric is damaged and needs patching. Follow the fabric care instructions.

FABRIC CARE

Zipdee awning fabric is made of acrylic fibres which cannot rot or mildew. The awning can be rolled up wet if necessary, but open it up to dry as soon as possible.

The acrylic fabric is synthetic and cannot support mildew or plant growth, however mildew can find a home on any pollen, plant spores, grain dust or other airborne plant material that can accumulate on the awning. If mildew forms on these elements, it can leave a stain which can be unsightly and difficult to remove.

Therefore, keep your awning as clean and dry as possible by hosing it down frequently between seasonal washing.

On a monthly basis, loosen hardened dirt and dust with a dry medium bristle brush, then thoroughly rinse top and bottom with a hose.

For a thorough cleaning to remove any stains, use Zipdee Washout Acrylic Awning Cleaner which can be ordered via your Airstream dealer. Wash both sides of the awning with the solution while scrubbing with a brush. Saturate the fabric and leave the solution on for 15-20 minutes (keep the fabric saturated by reapplying solution as needed). Rinse thoroughly. Repeat, if necessary.

SPARE PARTS

Zipdee awnings are manufactured in the USA from bright aluminium and acrylic fabrics, the perfect choice to complement your Airstream travel trailer.

Use only genuine Zip Dee replacement parts when repairs are needed.

Zipdee hardware varies on different models of Airstream. The hardware shown on the next page is one example only, to show names of commonly used parts. **Check your hardware serial number and hardware code number, you will find these on your front main arm bar tube. Copy them in the space below.**

Refer to Zipdee's Owner's manual contained in your Owner's pack for fuller explanations on the construction, use and maintenance of the awning.

HARDWARE – NAMES OF COMMON PARTS

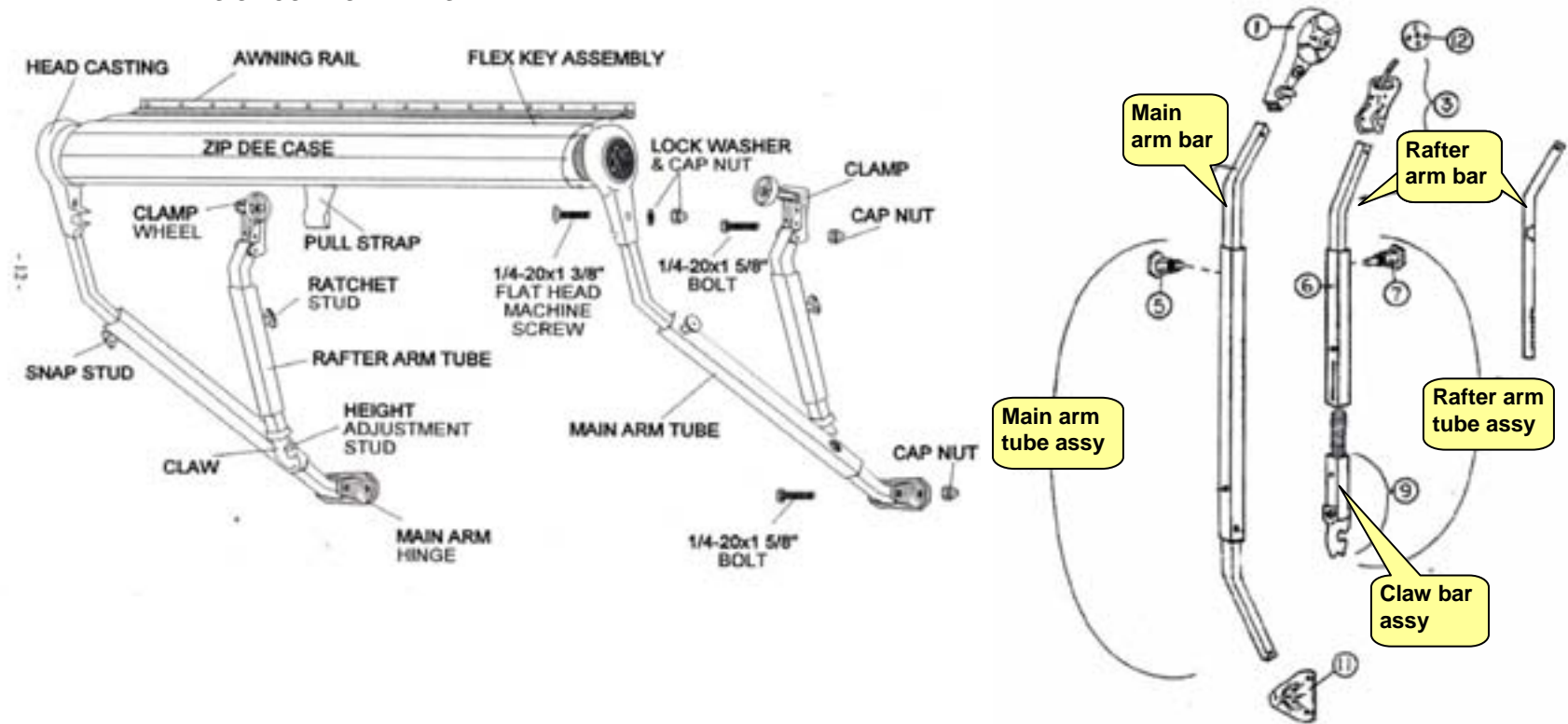

M1 – Service record

SERVICE

DATE:

Annual service carried out in accordance with manufacturer's recommendations

DEALER STAMP

SERVICE

DATE:

Annual service carried out in accordance with manufacturer's recommendations

DEALER STAMP

SERVICE

DATE:

Annual service carried out in accordance with manufacturer's recommendations

DEALER STAMP

SERVICE

DATE:

Annual service carried out in accordance with manufacturer's recommendations

DEALER STAMP

SERVICE

DATE:

Annual service carried out in accordance with manufacturer's recommendations

DEALER STAMP

SERVICE

DATE:

Annual service carried out in accordance with manufacturer's recommendations

DEALER STAMP

M1 – Service record

SERVICE

DATE:

Annual service carried out in accordance with manufacturer's recommendations

DEALER STAMP

SERVICE

DATE:

Annual service carried out in accordance with manufacturer's recommendations

DEALER STAMP

SERVICE

DATE:

Annual service carried out in accordance with manufacturer's recommendations

DEALER STAMP

SERVICE

DATE:

Annual service carried out in accordance with manufacturer's recommendations

DEALER STAMP

SERVICE

DATE:

Annual service carried out in accordance with manufacturer's recommendations

DEALER STAMP

SERVICE

DATE:

Annual service carried out in accordance with manufacturer's recommendations

DEALER STAMP

M1 – Service record

SERVICE

DATE:

Annual service carried out in accordance with manufacturer's recommendations

DEALER STAMP

SERVICE

DATE:

Annual service carried out in accordance with manufacturer's recommendations

DEALER STAMP

SERVICE

DATE:

Annual service carried out in accordance with manufacturer's recommendations

DEALER STAMP

SERVICE

DATE:

Annual service carried out in accordance with manufacturer's recommendations

DEALER STAMP

SERVICE

DATE:

Annual service carried out in accordance with manufacturer's recommendations

DEALER STAMP

SERVICE

DATE:

Annual service carried out in accordance with manufacturer's recommendations

DEALER STAMP