

2004 AIRSTREAM CLASSIC TRAILER OWNERS MANUAL

INTRODUCTION

The Owners Manual for your new Airstream trailer is designed to respond to the most frequent inquiries regarding the operation, function and care of the many systems that make modern trailering a joy.

Airstream realizes our customers possess varying degrees of expertise in the area of repairing and maintaining the appliances in their trailer. For this reason, the service and trouble-shooting information found in this manual is directed toward those with average mechanical skills. We also realize you may be more familiar in one area than you are in another. Only you know your capabilities and limitations.

We want you to use this manual, and hope you will find the information contained in it useful, however, should you ever feel you may be "getting in over your head" please see your dealer to have the repairs made.

A brief explanation of the operation of the appliances such as refrigerator, furnace, water heater and others are explained in this manual. However, you will also find the manufacturer's information supplied in a packet included with this manual more detailed.

All information, illustrations and specifications contained in the literature are based on the latest product information available at the time of publication approval.

Throughout this manual **CAUTION** and  **WARNING** notations are used.

Failure to observe **CAUTION** can damage equipment.

 **WARNING** notes the possibility of personal and/or fatal injury if not observed.

Note: If and when new materials and production techniques are developed which can improve the quality of its product, or material substitutions are necessary due to availability, Airstream reserves the right to make such changes.

The next page of this manual is a table of contents. Point your cursor to the subject, [colored blue](#), you would like to research. Right click your mouse while it is on the subject title and you will be taken to that area of the manual.

To get back to table of contents, click on the back arrow in the tool bar at the top of the document. The arrow will be lighted.

The next two pages contain an index of subject material in alphabetical order.

2004 AIRSTREAM CLASSIC TRAILER OWNERS MANUAL

A. WARRANTY AND SERVICE

[Warranty](#)
[Warranty Explanation](#)
[Service](#)
[Reporting Safety Defects](#)
[Maintenance Schedule](#)
[Maintenance Parts & Supplies](#)

B. TOWING

[Tow Vehicles](#)
[Brakes](#)
[Loading](#)
[Weighing](#)
[Hitching Up](#)
[Towing Tips](#)
[Pre-Travel Check List](#)

C. CAMPING

[Camping Safety](#)
[Overnight Stop](#)
[Slide Out Room](#)
[Extended Stay](#)
[Leveling & Stabilizing](#)
[Hook Ups](#)
[Winter Traveling](#)

D. EXTERIOR

[Cleaning](#)
[Chassis](#)
[Power Jack](#)
[Tires](#)
[Axle and Running Gear](#)
[Electric Brakes](#)

E. INTERIOR FURNISHINGS AND ACCESSORIES

[Fabric Care](#)
[Lounges & Tables](#)
[Features & Fixtures](#)
[Storage Areas](#)
[Smoke Alarm](#)
[Gas Detector](#)
[Fire Extinguisher](#)
[Exterior Windows Screens](#)

F. PLUMBING

[LP \(Liquid Petroleum\) Gas](#)
[Water](#)
[Drainage](#)
[Winterizing](#)
[Drain and Waste](#)
[Toilet](#)

G. ELECTRICAL

[Battery](#)
[Converter](#)
[12-Volt System & Components](#)
[TV Antenna](#)
[Satellite Antenna](#)
[Solar Panel](#)
[Bathroom Exhaust](#)
[Monitor Panel](#)
[110-Volt System & Components](#)

F. APPLIANCES

[Air Conditioner](#)
[Furnace](#)
[Range/Oven](#)
[Microwave](#)
[Refrigerator](#)
[Water Heater](#)
[Roof Vent, High Volume](#)

I. SPECIFICATIONS

AIRSTREAM CLASSIC TRAILER OWNERS MANUAL

Accessories.....	B-13	Electrical.....	G-1
Air Conditioner.....	H-1	12 Volt.....	G-1
Alignment.....	I-2	110 Volt.....	C-7, G-41
Antennas.....	G-30, G-33	Circuit Breakers.....	G-9, G-42, G-44
Appliances.....	H-1	Diagrams	
Axles.....	D-8	12 Volt.....	G-6 -- G-9
Awning.....	D-2	110 Volt.....	G-42, G-45
		7-Way Cable.....	B-3, G-5
Backing.....	B-11	Shoreline Cord.....	C-5, G-42
Battery.....	E-3, G-2, I-2	Trouble Shooting.....	G-11
Bath Exhaust.....	E-3, G-35	Escape Window.....	C-1, C-5, D-2, E-9
Bathroom.....	E-2	Exhaust Fans.....	E-4, F-3, G-35, H-7
Bearing.....	D-8	Extended Stay.....	C-4
Beds.....	E-2	Exterior Maintenance.....	D-1
Black Tank Flush.....	F-9, F-37		
Bottles, LP.....	F-1	Factory Service.....	A-5
Brake Controller.....	B-9, D-10	Fans.....	E-4, F-3, G-35, H-7
Brakes.....	B-2, B-9, D-10	Faucets.....	F-6, F-8, F-10
Breakaway Switch.....	B-2, D-10	Fill Valves, LPG.....	F-1
Bulbs.....	A-8, E-4, G-41	Filter, Water.....	F-6, F-10
		Fire Extinguisher.....	E-9
Camping.....	C-1	Flat Tire.....	C-4, D-5
Carpet.....	E-2	Furnace.....	C-7, E-4, H-2
Capacities.....	I-1	Fuses.....	A-8, C-3, E-8, G-3, G-10, G-34
Cargo.....	B-4, E-4		
Caution.....	Introduction	Galley.....	E-2, F-10
Chassis.....	D-3	Gas, LP.....	C-7, F-1
Check List.....	B-12	Gas Regulator.....	F-2
City Water Hook-Up.....	C-5, F-8, F-37	Grey Tank (Aux).....	F-37, I-1
Cleaning.....	D-1	Ground Fault Interrupter.....	G-43
Circuit Breakers.....	G-8, G-9, G-42	Grounding.....	G-10, G-39, G-40
Coaxial Cable Wiring.....	G-33	GVWR.....	B-4, I-1
Condensation.....	C-7	GAWR.....	B-5, I-1
Converter.....	G-3, G-41	Generator, remote hook up.....	G-44
Connector			
7-Way.....	G-5	Hitch.....	A-4, B-1, B-6, I-1
110-volt.....	G-41, G-44	Hitching Up.....	B-6
Couch.....	E-2	Hitch Weight.....	B-5, I-1
Countertop.....	E-2	Holding Tanks.....	F-29, F-36, F-37, I-1
Coupler.....	D-3	Hitch Ball Height.....	B-7, D-3, I-1, I-2
Curtains.....	E-2	Humidity.....	C-7
Control Panel.....	E-3, G-2, G-36		
		Interior.....	E-1
Dimensions.....	I-1	Jacks.....	C-4
Dinette.....	E-3	Stabilizing.....	C-2, C-4
Doors		Tire Changing.....	C-4, D-5
Main.....	D-2		
Screen.....	D-2		
Drain Valves.....	F-28		
Drainage.....	F-37		
Drapes.....	E-2		
Dump Valves.....	F-37, F-42 – F-44		

AIRSTREAM CLASSIC TRAILER OWNERS MANUAL

Lavatory	E-2	Table	E-3
Length, Trailer.....	I-1	Tires	D-5, I-1
Leveling.....	C-4	Tongue Latch.....	D-3
Lights	E-4, G-41	Tongue Weight	B-5, I-1
Loading	B-4, E-4	Toilet	F-45
Lounge	E-2	Towing	B-1, B-9
LP Bottles.....	F-1, F-2	Tow Car.....	B-1, B-7
LP Gas	C-7, E-8, F-1, F-2	TV	C-5
LP Gas Detector	E-8	TV Antenna	G-30, G-33
Maintenance Parts	A-8	Upholstery	E-1
Maintenance Record.....	A-9	Valves, Drain.....	F-28
Maintenance Schedule.....	A-6	Vents	E-4, F-3, G-35, H-7
Microwave.....	H-4	Warning	Introduction
Monitor Panel.....	E-3, F-6, F-36, G-36	Warranty.....	A-1
Oven	H-3	Washing.....	D-1
Overnight Stop	C-2	Waste System	F-36
Parking	C-2	Water System.....	F-6
Passing	B-10	Drainage	F-36
Plumbing	F-1	Filter	F-10
Power Cord.....	C-5, G-42	Heater	E-4, F-28, H-6
Power Jack.....	D-3	Inlet Connection	C-5
Range	H-3	Pump	E-3, F-6, F-8
Refrigerator	H-5	Strainer	F-6
Regulator, LP.....	F-2	Tank.....	F-6, F-28, I-1
Roof Vents.....	E-4, H-7	Valves	F-28
Rotation, Tire.....	D-7	Waxing	D-1
Safety	A-5, C-1, E-9, F-4, H-6	Weight	B-4
Safety Chains.....	B-8	Weight Distribution	B-6
Sanitizing.....	F-7	Wheel	
Screens	D-2, E-9	Torque.....	D-5
Service	A-5	Alignment	D-8, I-2
7-Way Conn	B-3, G-5, G-6	Bearing	D-8
Sewer Hose.....	F-36	Windows.....	D-2, E-9
Shower	E-2	Winter Traveling.....	C-7
Sink	E-2	Winterizing	F-29
Slide-out Room.....	C-2	Wiring	See Electrical
Smoke Alarm.....	E-5		
Sofa	E-2		
Solar Panel.....	G-34		
Specifications	I-1		
Stabilizing.....	C-4		
Step	D-2		
Storage	E-4, F-29		
Stove	H-3		
Suspension.....	D-8		

AIRSTREAM CLASSIC TRAILER OWNERS MANUAL

WARRANTY COVERAGE

When you buy a new Airstream Travel Trailer from an authorized Airstream dealer, Airstream, Inc., warrants the trailer from defects in material and workmanship as follows:

BASIC WARRANTY PERIOD

This warranty extends for a period of two years from the date of original retail purchase.

ITEMS COVERED

Any part of the trailer or any component equipment installed by the factory is covered by the basic warranty *except* the following items, which are *not covered*:

- Tires
- Batteries

The tire and battery warranties will be handled by their respective service points and according to their written policy. This limited warranty does not include failure caused by accident, abuse, normal wear, overload, or any cause not attributable to a defect in original material or workmanship of the trailer or component equipment as installed by the factory.

LIMITATION OF IMPLIED WARRANTIES

All warranties of merchantability and fitness for a particular purpose, whether written or oral, expressed or implied, shall extend only for a period of two years from the date of original purchase. There are no other warranties, which extend beyond those described on the face hereof and which expressly excludes conditions resulting from normal wear, accident, abuse, exposure or overload. Some states do not allow limitation on how long an implied warranty lasts, so the above limitations may not apply to you.

AIRSTREAM'S RESPONSIBILITY

The basic **Airstream Limited Warranty** applies for a period of two years from the date of original purchase, and the application date of all warranties is that indicated on the owner's identification card. Defects in items covered under this Warranty will be corrected without cost upon the return, at the owner's expense, of the trailer or defective part to an authorized Airstream dealer.

AIRSTREAM CLASSIC TRAILER OWNERS MANUAL

CARE AND MAINTENANCE

This warranty covers only defective material and/or workmanship; adjustments are made at the factory prior to shipment, and rechecked by the dealer prior to delivery to the customer. Adjustments thereafter become a customer responsibility.

Each Airstream exterior (not including the underside) is clear coated to prevent oxidation. This application is covered by a two-year warranty against peeling. Prolonged exposure to salt air or industrial fall-out will permit penetration through the coating material, causing damage to the exterior finish. Since Airstream, Inc., has no control over these conditions, it is necessary for the owner to wash and maintain their trailer as instructed in the Owner's Manual.

The owner is also responsible for following all recommendations, instructions and precautions contained in the Airstream Trailer Owner's Manual and the individual manuals furnished by the chassis, appliance and other manufacturers.

INSTALLATIONS NOT COVERED

Airstream, Inc., does not accept any responsibility in connection with any of its trailers for additional equipment or accessories installed at any dealership or other place of business, or by any other party. Such installation of equipment or accessories by any other party will not be covered by the terms of this warranty.

IF REPAIRS ARE NEEDED

If your trailer needs repairs under the terms of the basic Airstream Limited Warranty, you should:

1. Take your trailer to your selling dealer or other Authorized Airstream Dealer.
2. If the dealer is incapable of making the repair, request that he contact the Service Administration Department at Airstream, Inc., for technical assistance.
3. If repairs are still not made, the customer should contact:

AIRSTREAM, INC.
419 W. Pike Street - P.O. Box 629
Jackson Center, Ohio 45334-0629
Attention: Owner Relations Department

Furnish the following information:

- The complete serial number of the trailer
 - Mileage
 - Date of original purchase
 - Selling dealer
 - Nature of service problem and steps or service, which have been performed. (The owner may be directed to another dealer at the owner's expense.)
4. If, after taking the above steps, repairs are still not complete, the Airstream owner may request the trailer be brought to the Factory Service Center at the owner's expense.

AIRSTREAM CLASSIC TRAILER OWNERS MANUAL

DEALER REPRESENTATION EXCLUDED

The full extent of the basic **Airstream Limited Warranty** is set forth in detail in the folder, and in the explanation of the basic **Airstream Limited Warranty** covered in the Airstream Trailer Owner's Manual. Airstream Inc. will not be responsible for additional representations or implied warranties made by any of its dealers to the extent those representations are not a part of, or are contrary to, the terms and conditions of the basic Airstream Limited Warranty.

CONSEQUENTIAL AND INCIDENTAL DAMAGES

Airstream, Inc., will not be responsible for any consequential or incidental expenses or damages resulting from a defect. Incidental expenses include, but are not limited to: travel expenses, gasoline, oil, lodging, meals, telephone tolls, and loss of work and loss of use of the trailer. Some examples of consequential damages would be: stained curtains due to rain leaks or delaminated floor caused by a plumbing leak. Some states do not allow the exclusion or limitation of incidental or consequential damages, so the above limitation or exclusion may not apply to you.

WARRANTY TRANSFER

The basic **Airstream Limited Warranty** is transferable to subsequent owners for the duration of the warranty period. Warranty transfer application forms are available from your dealer or the Airstream Inc. Service Administration Department.

CHANGES IN DESIGN

Airstream Inc. reserves the right to make changes in design and improvements upon its product without imposing my obligation upon itself to install the same upon its products theretofore manufactured.

This warranty gives you specific legal rights, and you may also have other rights, which vary from state to state.

AIRSTREAM CLASSIC TRAILER OWNERS MANUAL

EXPLANATION OF AIRSTREAM LIMITED WARRANTY

The Airstream Limited Warranty is detailed in a separate folder. A plastic WARRANTY IDENTIFICATION CARD is sent to you after Airstream receives notification from your dealer of the sale. Since this I.D. card is necessary to obtain warranty, it should be kept in the trailer or on your person during the warranty period.

EXCLUSIONS:

Normal Wear

Items such as tires, water purifier packs, curtains, upholstery, floor coverings, window, door and vent seals will show wear or may even wear out within the two year warranty period depending upon the amount of usage, weather, and atmospheric conditions.

Accident

We strongly urge our dealers and customers to inspect the trailer upon receipt of delivery for any damage caused by accident while being delivered to the dealer, or while it is on the dealer's lot. Damage of this nature becomes the dealer or customer's responsibility upon acceptance of delivery, unless Airstream is notified and the person making the delivery verifies the damage. Glass breakage, whether obviously struck or mysterious, is always accidental and covered by most insurance policies.

Abuse

Lack of customer care and/or improper maintenance will result in early failure for which Airstream cannot be held responsible.

Exposure

Not unlike a car, the steel parts of a trailer can and will rust if subjected to prolonged exposure to moisture, salt air, or corrosive air-borne pollutants without repainting. Aluminum oxidizes when unprotected under similar conditions, and refinery chemicals of a sulfurous nature are harmful to finishes if not washed off periodically. Extremely hot or direct sunlight will deteriorate rubber and fade curtains and upholstery. Conditions of this nature, although they may be normal for the area, are beyond Airstream's control and become the responsibility of the owner.

Although it is our obligation to correct a rain or plumbing leak within the terms of the limited warranty, it is the owner's responsibility to use reasonable, prudent care to minimize foreseeable secondary damage, such as a delaminated floor, stained upholstery, carpeting, drapes etc.

Overload

Damage due to loading, either beyond capacity or to cause improper towing because of improper balance, is beyond Airstream's responsibility. The Airstream trailer is engineered to properly handle the gross vehicle load rating on the certification label. Load distribution has a definite effect upon the towing characteristics and attitudes of the trailer. Level hitch installations are a necessity, and very important on a tandem axle trailer. There are limits to the amount of load that can be safely transported depending upon speed and road conditions, and reasonable cause to believe these factors have been exceeded could void the Airstream warranty. For additional information on the loading of your trailer, consult your Owner's Manual or gross vehicle weight rating plate.

The Airstream axle is manufactured to a tolerance of 1-degree camber and 1/8" toe-in. These tolerances will only change if the trailer is subjected to abuse, such as dropping off a sharp berm, striking a curb, or hitting a deep hole in the road. Such damage could be considered as resulting from an accident which risks are not covered under the warranty. Abnormal tire wear and/or wheel alignment resulting from such damage is not covered under the terms of the warranty.

AIRSTREAM CLASSIC TRAILER OWNERS MANUAL

SERVICE:

The Airstream Silver Key Delivery Program is an exclusive Airstream program. Before leaving the factory, each and every vital part of the trailer is tested for performance. Each test is signed and certified by an inspector. After the trailer arrives on your dealer's lot all of these vital parts and systems are again tested. When you take delivery of your new trailer you will receive a complete check out.

Silver Key Delivery does not stop here. At that time a specified list of performance checks on your trailer equipment will be conducted and any deficiencies you have experienced since taking delivery will be corrected.

Please contact your dealer if you need service. Major service under your Airstream Limited Warranty is available through our nationwide network of Airstream Dealer Service Centers. An up-to-date list of Dealer Service Centers has been provided with your new trailer. This list is current as of the date of this publication.

Occasionally dealerships change, or new dealers are added who may not appear on this list. For this reason, it is suggested that you contact your local dealer from time to time and bring your list up to date. He can also provide you with additional copies if you need them. **ALL CENTERS OPERATE ON AN APPOINTMENT BASIS FOR THE UTMOST EFFICIENCY.**

When you require service from the Airstream Factory Service Center, or a Certified Dealer Service Center, please contact the service manager for an appointment, and kindly inform him if you are unable to keep the appointment date or wish to change it.

Service may be arranged at the Factory Service Center by contacting the Service Coordinator at

Airstream Factory Service Center P.O. Box 629
419 W. Pike Street
Jackson Center, Ohio 45334-0629
937-596-6111

REPORTING SAFETY DEFECTS

If you believe that your vehicle has a defect, which could cause a crash or could cause injury or death, you should immediately inform the National Highway Traffic Safety Administration (NHTSA) in addition to notifying Airstream, Inc.

If NHTSA receives similar complaints, it may open an investigation, and if it finds that a safety defect exists in a group of vehicles, it may order a recall and remedy campaign. However, NHTSA cannot become involved in individual problems between you, your dealer, or Airstream, Inc.

To contact NHTSA you may either call the Auto Safety Hotline toll-free at 1-800-424-9393 (or 366-0123 in Washington, D.C. area) or write to: NHTSA, U.S. Department of Transportation, Washington, D.C. 20590. You can also obtain other information about motor vehicle safety from the Hotline.

AIRSTREAM CLASSIC TRAILER OWNERS MANUAL

MAINTENANCE SCHEDULE



WARNING: FAILURE TO MAINTAIN YOUR COACH CAN CAUSE PREMATURE AND UNEXPECTED PARTS BREAKAGE AND/OR ERRATIC OPERATION THAT MAY BE HAZARDOUS.

Note: See appliance manufacturer's literature for further information

EVERY 1,000 MILES OR 60 DAYS

Escape Window	Check operation of latches and upper hinge.
*Battery	Check water level
Smoke Alarm	Test and replace battery as required
Tires	Check tire pressure (See Specifications)),
Hitch	Check for loose bolts or unusual wear.
GFI Circuit Breaker	Test and record.



WARNING: On new trailers or whenever a wheel is removed, check lug nuts at 25, 50, and 100 miles. Torque aluminum wheels to 85 ft. lbs and steel wheels to 95 ft. lbs.

EVERY 5,000 MILES OR 90 DAYS

Exterior Door locks	Lubricate with dry graphite
Exterior Hinges	Lubricate with light household oil
LPG Hold Down	Lubricate with light household oil
LPG Regulator	Check bottom vent for obstructions
Main Door Striker Pocket	Coat with paraffin.
Wheel Lug Nuts	Aluminum wheels torque to 85 ft. lbs, steel to 95 ft. lbs.
Break Away Switch	Pull pin and lubricate with household oil
7-Way Plug	Spray with contact cleaner.
Hitch Ball Latch	Lubricate with non-detergent motor oil
Hitch Ball	Lubricate with hitch ball lube or wheel bearing grease.
Range Exhaust Hood	Clean fan blades and wash filter.
Roof Vent Elevator Screws	Lubricate with light household oil
Main Door Step	Lubricate moving parts and check.

* As a battery ages and becomes less efficient, the water level should be checked at more frequent levels.

AIRSTREAM CLASSIC TRAILER OWNERS MANUAL

EVERY 10, 000 MILES OR 6 MONTHS

Brakes	Inspect, adjust or replace as necessary
Wheel Bearings	Clean and repack
Tires	Inspect and rotate
Spare Tire Carrier	Lubricate moving parts.
Seals, Windows & Door	Clean with mild detergent and coat with "Slipicone".
TV Antenna	Lubricate all moving parts with silicone lubricant.
Exterior	Wax
Escape Window	Lubricate latches with WD-40.

EVERY YEAR

Battery	Clean, neutralize and coat terminals with petroleum jelly.
A-Frame, Step	Wire brush and paint frame at front and rear.
LP Bottles	Have purged by LP supplier.
Seams	Check and reseal exterior seams, windows, lights and vents if necessary. Use Ten X or equivalent.
Hitch Coupler and Ball	Check for wear or damage. Assure all parts operate freely. Replace any component if worn or damaged.

AIRSTREAM CLASSIC TRAILER OWNERS MANUAL

SUGGESTED MAINTENANCE PARTS AND LUBRICANTS

BULBS, EXTERIOR

Taillight	#2057
Back Up	#1156
License Plate	# 53, wedge base #
Clearance Light	194, wedge base
Door Light	#1003
Convenience Light (Dump Valve)	# 53, wedge base
Convenience Light (Hitch)	# 193, wedge base

BULBS, INTERIOR

Ceiling Light (Incandescent)	#1141
Ceiling Light (Fluorescent)	#F14T8-CW #F8T5-CW
Ceiling Light (Small Fluorescent, Thin Lite)	#F8T5-CW
Indirect, Dining & Bedroom (Fluorescent)	#F18T8-CW & F15T8-CW
Wardrobe Light & Dinette Light	#561
Wall Light	#1076
Reading Light	#JC-10, wedge base



WARNING: Always replace the light bulb on an interior or exterior light fixture with the correct bulb for that light. Failure to heed this warning could cause fire, property damage, personal injury, or death.

FUSES

Entertainment Center	ATC 15 Amp
Battery Cable Fuses (Canadian approved trailers only)	SLC 50 Amp

MISCELLANEOUS

Water Hose Gaskets	Wheel Bearing Grease
Extra Hair Pin Clips for Hitch	Grease Seals
Dry Graphite	WD-40 or Equivalent Aerosol Lubricant
Oil Can with 30 Weight Non-Detergent Oil	Silicone Lubricant
Light Household Type Oil	Spray Contact Cleaner
Hitch Ball Lube (May use wheel bearing grease.)	Sealer - Ten X

AIRSTREAM CLASSIC TRAILER OWNERS MANUAL

NOTES

AIRSTREAM CLASSIC TRAILER OWNERS MANUAL

TOWING YOUR AIRSTREAM

TOW VEHICLE EQUIPMENT

If you plan to buy a new vehicle to tow your trailer we suggest that you include in your purchase the towing options offered by most vehicle manufacturers. These include such things a heavy-duty alternator and radiator, heavy-duty springs, (See Note:) shock absorbers, transmission cooler, heavy-duty fan and flasher unit and others, depending upon the make of the vehicle.

Transmissions may be manual or automatic, but an automatic transmission may prolong your tow vehicle's life and generally does a better job of controlling engine loads than the average driver using a manual shift.

Having adequate power is very important when considering the purchase of a new vehicle or the trailer towing capability of your present one. American manufacturers realize more than 30% of the vehicles they sell will be used for towing some type of trailer. The dealers are provided with guidelines to use when helping a customer decide on a tow vehicle. The guidelines are not just determined by the power output of the engine. The gear ratio of the differential is also a very part of the guideline.

Inspect vehicle's hitch regularly for loose bolts or nuts, cracked welds, loose ball mounts, worn parts, etc.

New trailerists often carry more food and other supplies than really needed. Remember that every item you take along is one more thing to stow and adds weight to the total load you must pull. Consolidate items in shelves, lockers, and in the refrigerator. It is better to have one full and one empty locker, than two half empty ones. Special care must be taken not to overload the front and rear ends of the trailer.

NOTE: Be realistic when ordering heavy duty springs. Only springs heavy enough to support your loaded vehicle (not including trailer) are necessary. Too harsh of spring rate will only shorten the life of the tow vehicle and trailer, and will make your journeys less enjoyable.

AIRSTREAM CLASSIC TRAILER OWNERS MANUAL

ELECTRIC BRAKES

The brakes are operated by 12 volt current from your tow vehicle and **MUST BE HOOKED UP SO THAT YOU HAVE AN INTEGRAL SYSTEM WITH YOUR TOW VEHICLE BRAKES.** To prevent problems and insure satisfactory braking action, install an electronic controller in line with the brakes in your tow vehicle.

An electronic controller installed in your tow vehicle will synchronize the trailer brakes with your tow vehicle brakes. It is designed to apply the trailer brakes with your tow vehicle brakes.

Your brake controller should be adjusted to provide for a slight lead of the trailer brakes over the tow vehicle brakes. Follow the directions provided with your controller and keep the information for future reference. Don't be afraid to ask questions! If you don't understand the directions, have the installer explain the procedures.

Due to normal brake lining wear, the brakes and the controller setting should be checked and readjusted, if necessary, during the trailer manufacturer's recommended inspection intervals.

Note: Brake lining adjustment should be periodically checked (fully) to be sure trailer brakes are in the same adjustment as the tow vehicles.

Properly set these adjustments will provide for safe comfortable stops. They will also help assure optimum brake and tire life for both the tow vehicle and the trailer.

In THE EVENT OF AN ACCIDENTAL SEPARATION of the tow vehicle and the trailer, the BREAK-AWAY SWITCH will set and lock the trailer brakes for a sufficient length of time to stop the trailer. The switch is activated when the wire attached to it and to the tow vehicle pulls out the small pin in the front of the unit. **THIS PIN SHOULD BE PULLED OUT, LUBRICATED WITH LIGHT HOUSEHOLD OIL, AND REPLACED EVERY 90 DAYS.**

To prevent corrosion within the breakaway switch, pull the switch's pin straight forward and spray the inside of the switch through the hole with an electric contact cleaner (such as Spra- Kleen) and reinsert pin. A drop of light household oil on the groove near the base of the pin will allow the pin to operate freely. **WHEN THE TRAILER IS CONNECTED TO THE TOW VEHICLE, THE BREAKAWAY SWITCH LOOP SHOULD BE ATTACHED TO THE PERMANENT FRAME OF YOUR HITCH.** When disconnecting the trailer from the tow vehicle remove wire loop from the frame. **DO NOT REMOVE PIN FROM SWITCH BECAUSE THIS WILL APPLY THE TRAILER BRAKES.**

CAUTION: Do not use breakaway switch for parking brake.

AIRSTREAM CLASSIC TRAILER OWNERS MANUAL

WIRE ROUTING SCHEMATIC - 7 WAY PLUG TO BATTERIES AND 12 VOLT DISTRIBUTION PANEL

952336

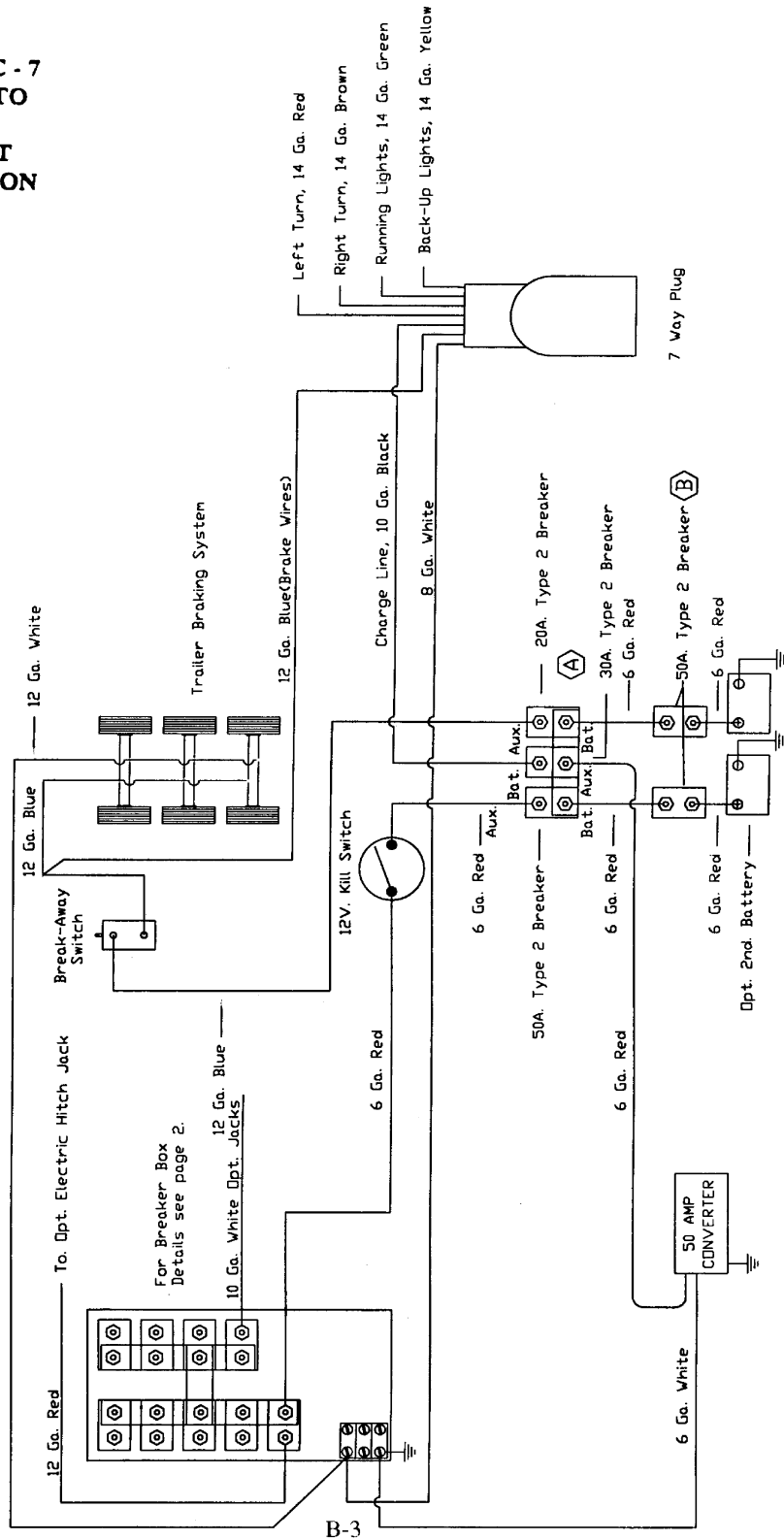

AIRSTREAM CLASSIC TRAILER OWNERS MANUAL

LOADING

Below is a sample of the weight information chart provided in all Airstream vehicles. This information can be found in your vehicle on the back of the first wardrobe door on the curbside of the vehicle about 60" up from the floor.

TRAILER WEIGHT INFORMATION

VIN OR SERIAL NUMBER

GVWR (GROSS VEHICLE WEIGHT RATING) IS THE MAXIMUM PERMISSIBLE WEIGHT OF THIS TRAILER WHEN FULLY LOADED. IT INCLUDES ALL WEIGHT AT THE TRAILER AXLE(S) AND TONGUE OR PIN.

UVW (UNLOADED VEHICLE WEIGHT) IS THE WEIGHT OF THIS TRAILER AS MANUFACTURED AT THE FACTORY. IT INCLUDES ALL WEIGHT AT THE TRAILER AXLE(S) AND TONGUE OR PIN. IF APPLICABLE, IT ALSO INCLUDES FULL GENERATOR FLUIDS, INCLUDING FUEL, ENGINE OIL AND COOLANTS.

CCC (CARGO CARRYING CAPACITY) IS EQUAL TO GVWR MINUS EACH OF THE FOLLOWING: UVW, FULL FRESH (POTABLE) WATER WEIGHT (INCLUDING WATER HEATER), FULL LP-GAS WEIGHT.

CARGO CARRYING CAPACITY (CCC) COMPUTATION	POUNDS	KILOGRAMS
GVWR		
MINUS UVW		
MINUS FRESH WATER WEIGHT OF GALLONS @ 8.3 LB/GAL		
MINUS LP-GAS WEIGHT OF GALLONS @ 4.5 LB/GAL		
= CCC FOR THIS TRAILER*		

*DEALER INSTALLED EQUIPMENT WILL REDUCE CCC

CONSULT OWNER MANUAL(S) FOR SPECIFIC WEIGHING INSTRUCTIONS AND TOWING GUIDELINES. CD-132

- Gross Vehicular Weight Rating (**GVWR**): is the maximum permissible weight of this trailer when fully loaded. It includes all weight at the trailer axle (s) and tongue or pin.
- Unloaded Vehicle Weight (**UVW**): is the weight of this trailer as manufactured at the factory. It includes all trailer weight at the trailer axle (s) and tongue or pin. If applicable, it also includes full generator fluids, including fuel, engine oil, and coolants.
- Cargo Carrying Capacity (**CCC**): is equal to GVWR minus each of the following: UVW, full fresh (potable) water weight (including water heater), and full LP-Gas weight.
- Gross Axle Weight Rating (**GAWR**): is the value specified as the load carrying capacity of a single axle system, as measured at the tire-ground interfaces.

When loading heavy objects such as tools, skillets, irons, and boxes of canned goods, etc. keep them as low as possible - preferably on the floor. Try to hold additional weight behind the axle to a minimum.



WARNING: Never add items such as generators, heavy toolboxes or motorcycle racks to the back of the trailer. Weight behind the axle will tend to magnify any sway that may occur when passing trucks or in gusty wind. If a heavy generator is mounted on the rear bumper what may have been an almost unnoticeable sway turns into a severe sway you may not be able to control.

CAUTION: Damage to your trailer caused by mounting heavy objects on the rear is considered abuse, and is not covered by warranty.

WEIGHING YOUR TRAILER

The diagram shows how to weigh the trailer on scales.

The allowable personal cargo must be distributed in your trailer in such a manner that the Gross Axle Weight Rating is not exceeded.

To determine this it is necessary to load all of your allowable personal cargo and variable weights. Then hitch the trailer to the tow vehicle with load equalizing hitch properly adjusted as shown on the following pages.

AIRSTREAM CLASSIC TRAILER OWNERS MANUAL

Place the trailer on a scale with both axles only on the scale (see 2). If the weight on the axles exceeds the axle system G.A.W.R. then some of the personal cargo must be redistributed forward in order to place some of this weight on the tongue.

The tongue weight should be in between 10% - 15% of the trailer's total weight, but must not exceed 1,000 lbs. Some tow vehicle manufacturers may restrict the amount of tongue load to a lower value. To determine tongue load, unhitch tow vehicle and place the tongue hitch post on a scale. The trailer must be properly loaded as determined above, with your allowable personal cargo and variable weights.

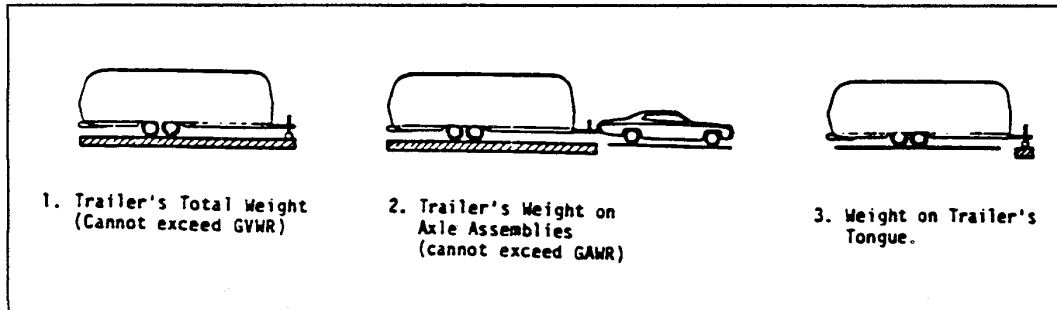

Use a scale, such as a bathroom scale, that has a lower weight limit than your tongue load to check the tongue weight by using the following method (see illustration).

Place a piece of wood of approximately the same thickness as the bathroom scales on the ground in line with the trailer hitch jack as shown. It should be so spaced that a short piece of pipe or other round piece will lay exactly one foot from the centerline of the jack extension. Place the scales so that another round piece can be exactly two feet from the centerline of the jack extension in the other direction. Place a 4 x 4 on the two round pieces and screw the jack extension down on the top of the 4 x 4 until the tongue of the trailer is supported by it. Multiply the scale reading by three. This will be the tongue weight of your trailer. If you exceed the capacity of the bathroom scales, increase the two-foot dimension to three or four more feet, but always multiply the scale reading by the total number of feet between the wood and scales.

CAUTION: Be sure trailer is level when you read scales.

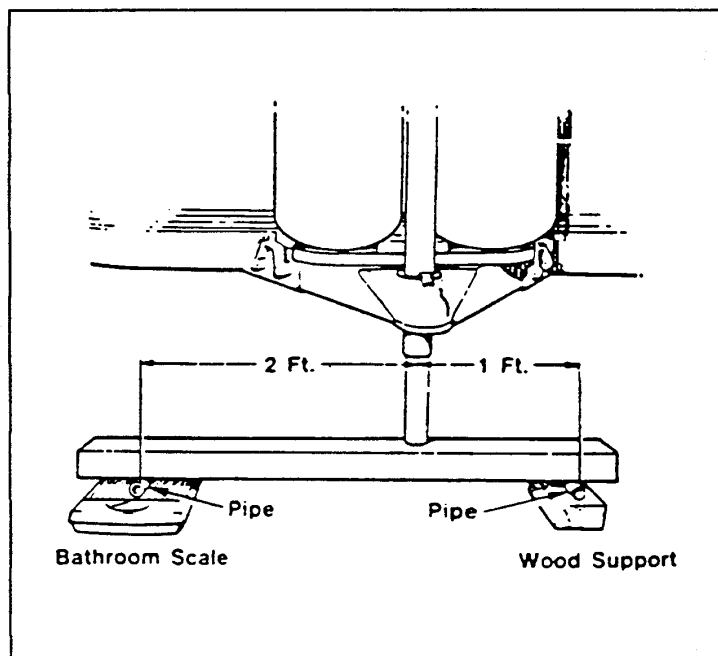

AIRSTREAM CLASSIC TRAILER OWNERS MANUAL

HITCHING UP

Hitching up your trailer is something that will become almost second nature with practice. The following section includes proper hitch load distribution and a procedure for hitching up.

Equalizing Hitch Load Distribution

When a trailer is hitched up properly to a tow vehicle with a load equalizing hitch, approximately 1/3 of the trailer's tongue weight will be on the trailer's axles and 2/3 will be transferred to the tow vehicle, 1/3 of this weight transfer will be carried by the front wheels and 1/3 by the rear wheels of the tow vehicle (See diagram). Thus, the tire load of each wheel on the tow vehicle will be increased by 1/6 of the trailer's tongue weight. The tire air pressure of the tow vehicle should be increased to compensate for this additional weight. Refer to the vehicle's owner's manual for this information.

 **WARNING:** The tongue weight should be approximately 10% to 14% of the trailer's total weight. Under no condition should it exceed the hitch rating. Your hitch installer should provide your hitch rating information to you.

Sway Control Device

Although Airstream has not intruded into the hitch manufacturers field of expertise and preformed formal testing, we find the vast majority of Airstream owners purchases sway-control devices.

When passed by large trucks or when exposed to sudden crosswinds the trailer will be "pushed" and this action will be felt in the tow vehicle. It's our understanding the sway control devices will reduce the amount of movement and make towing more comfortable and add some safety.

Follow the directions of the sway control manufacturer when having it installed and using it.

Steps for Hitching Up

Jack up the trailer hitch until there is clearance for the HITCH BALL to slide under. Remove the safety pin, slide the locking lever forward and raise. Back the tow vehicle straight back to the hitch. (See Fig. 2). This can best be accomplished through the use of prearranged hand signals with the help of another person; but if you are hitching up by yourself we recommend the use of a HOOK-UP VIEW MIRROR.

Lower the trailer hitch onto the hitch ball. Then close the locking lever and insert safety pin. (See Fig. 3)

Now raise the trailer and tow vehicle to the full height of the hitch jack (See Fig. 8) and then attach the LEVELING BARS. (See Fig. 4 & 5) and lever the tension on the bars (see figure 6. Lower the tow vehicle and trailer (See Fig. 8).

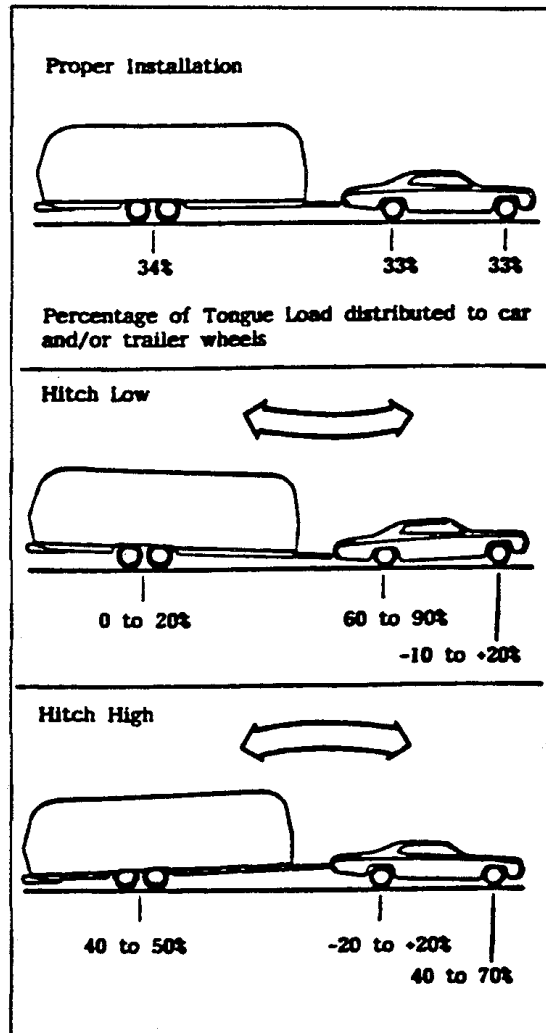

AIRSTREAM CLASSIC TRAILER OWNERS MANUAL

The hitch ball should be level to slightly higher. Readjust leveling bars until this condition is correct by increasing or decreasing the length the chain engaged in "A" frame saddle bracket (Figure 5). Short chain raises hitch ball, longer chain lowers it. A level condition will result in the best balance for towing and steering control as the weight-equalizing hitch distributes the hitch load.

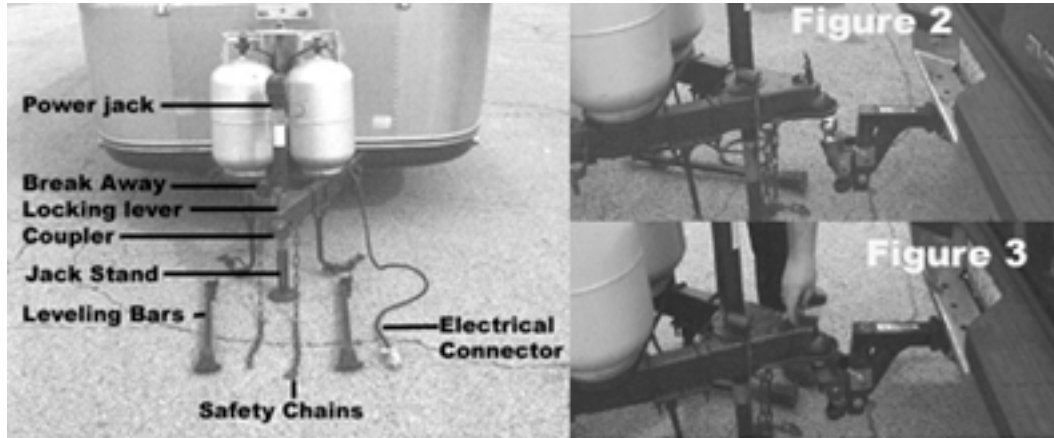

A low hitch ball increases tail wagging tendencies by lowering the nose of the trailer, thus changing the center of support for the trailer and reducing the weight on the four wheels of the tow vehicle. With proper hitch installation and hitching up, the bar should have a noticeable amount of the deflection or bending. A little practice with your rig will teach you how far to pull the bar; you may wish to mark the chain links that match your rig.

Always choose level ground for checking correct hookup.



AIRSTREAM CLASSIC TRAILER OWNERS MANUAL

Note: If your tow vehicle is equipped with adjustable load leveling air shocks, you must load the tow vehicle first with typical luggage and passengers and bring it back to level. Then attach the trailer and adjust the load leveling bars. Otherwise the air shocks on the tow vehicle will overload the rear wheels. **Do not use air shocks to level tow vehicle and trailer after hitching up.**



Note: Leveling the trailer end to end, then measuring from the ground to the inside top of the ball socket determines hitch ball height for the tow vehicle

Attach the safety chains (see figure 7) to the welded portion of the hitch or tow vehicle's frame, but never to the removable ball mount. Cross the safety chains under the hitch.

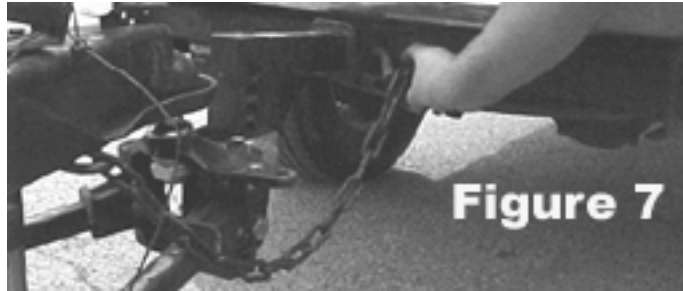

Caution; retract the hitch jack completely for maximum ground clearance. Remove the jack pad and stow in the tow vehicle's trunk along with the leveling jack and other gear used when stopped. **NEVER TOW YOUR TRAILER WITH THE JACK DOWN.** Check that the foldaway step is up and that the main door is completely closed and **LOCKED** for towing. If it is not locked the constant vibration of travel may cause it to open with possible damage.



Move the rig ahead about 50 feet and test the trailer brakes, then check the ground for forgotten objects. Regularly check the condition of your tires, air pressure, and the tightness of your lug nuts.

NOTICE! **CHECK WHEEL LUGS**

1. On first trip, tighten wheel lugs at the start, and at 25, 50, and 100 miles.
2. There after, check wheel lugs before each trip.
3. Following winter storage, check before beginning a trip. Following excessive braking, inspect wheel lugs

AIRSTREAM CLASSIC TRAILER OWNERS MANUAL

TOWING TIPS

We want every owner to be a safe and courteous driver. A few hours of towing practice in a large empty supermarket lot will make pulling your trailer over the road much easier. Line out two corners for left and right turns. You may also use these corners to practice backing and parking.

OBSERVE THAT THE TRACKS MADE BY THE TRAILER WHEELS ARE DISTINCTLY DIFFERENT FROM THOSE MADE BY THE TOW VEHICLE. Studying this will make it easier for you to correct mistakes. Truck or trailer type fender or door grip rear view mirrors are a must for maximum visibility and in most states the law requires them.

After thoroughly inspecting your hitch, brakes, and tires you should be ready to tow. Check traffic, signal that you are about to pull away, and start slowly. Look often in your mirrors, and observe the action of the trailer, then carefully move into the proper lane of traffic. Remember that the trailer wheels will not follow the path of the tow vehicle wheels; therefore, **WIDER TURNS ARE NECESSARY WHEN TURNING TO THE LEFT OR TO THE RIGHT.**

ON FREEWAYS OR EXPRESSWAYS try to pick the lane you want and stay in it. Always maintain plenty of space between you and the car ahead, at least the length of the tow vehicle plus trailer for every ten miles per hour. Remember that in order to pass another vehicle you will need longer to accelerate. You must also allow for the length of the trailer when returning to the right hand lane.

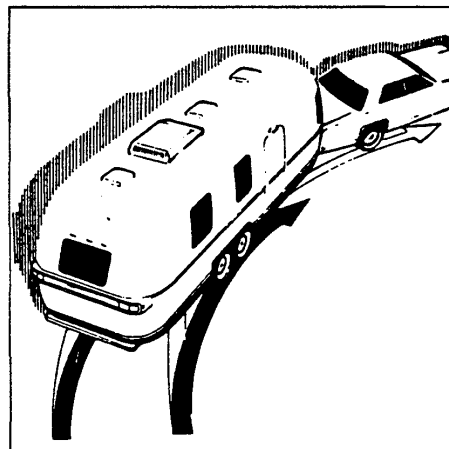
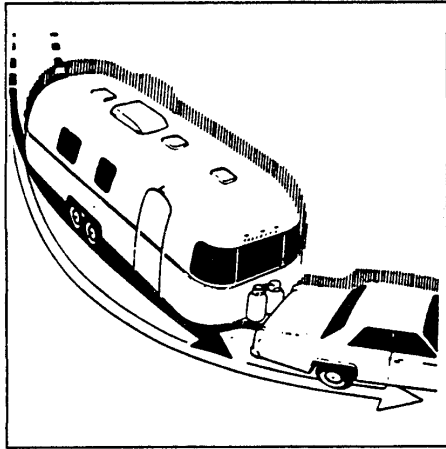

Tracking

On a two-lane road cars will be lining up behind you because you travel at a lower speed. It is both courteous and sensible to signal, pull onto the shoulder, and let them pass. Your trailer is designed to be towed easily at any legal speed, so if you are not careful you may be inclined to forget it is there.

The **BRAKE CONTROLLER** is activated when you apply the brakes of the tow vehicle. Your tow vehicle brakes will automatically apply the trailer brakes first when properly adjusted. This will help keep your tow vehicle and trailer in a straight line and make you stop as if you were driving the tow vehicle alone. If swaying or swerving should occur, briefly operating the controller separate from the vehicle brakes may help correct the situation. Practice this maneuver on a clear highway. Don't wait for an emergency then grope for the controller.

When trailering you might encounter a temporary cooling system overload during severe conditions such as hot days when pulling on a long grade, when slowing down after higher speed driving, or driving long idle periods in traffic jams. If the hot indicator light comes on, or the temperature gauge indicates overheating and you have your air conditioner turned on, turn it off. Pull over in a safe place and put on your emergency brake. Don't turn off the engine. Increase the engine idle speed. Lift the engine hood and check for fluid leaks at the radiator overflow outlet. Check to see that all drive belts are intact and the fan is turning. If you have a problem have it fixed at the next opportunity. If there is no problem the light should go off or temperature should come down within one minute. Proceed on the highway a little slower. Ten minutes later resume normal driving.

AIRSTREAM CLASSIC TRAILER OWNERS MANUAL

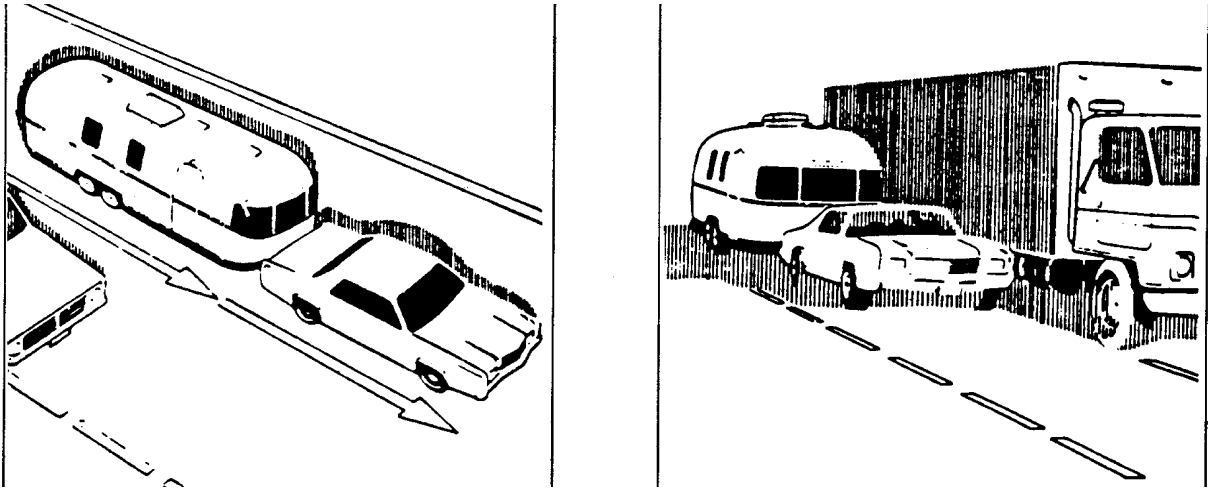

Passing

 **WARNING:** Never open a radiator cap when the tow vehicle is hot. Check the coolant level when the vehicle is cool.

When going downhill in dry weather, down shift so that engine compression will slow the whole rig down. Take dips and depressions in the road slowly and do not resume normal driving speeds until you are sure that the trailer wheels are clear of the dip.

 **WARNING:** On slippery pavement do not use engine drag to help slow down as this may cause the rear wheels of the tow vehicle to skid. On icy pavement drive slowly and if you feel the tow vehicle skidding gently apply the trailer brakes only. This will bring the tow vehicle and trailer back into a single line. Chains do not help trailer wheels.

When driving in mud and sand let the momentum carry the rig through. Apply power gently and use as little as possible. Stay in the tracks of the vehicle ahead and keep the tow vehicle in the highest possible gear. If you get stuck it is best to tow out the entire rig together without unhitching.

Despite the best hitch you will notice that whenever a large bus or truck overtakes your rig the displaced air first pushes the trailer rear slightly to the right and then affects the front. It may be necessary to steer very slightly, momentarily, toward the bus or truck to help compensate for the sway induced by the passing-vehicle. Do not apply the vehicle brakes, as this can tend to exaggerate the situation. You may find, however, that briefly applying the trailer brakes with your manual control will help eliminate sway.

 **WARNING:** When stopping on a hill or slope, leaving your tow vehicle in gear is not enough for standstill safety. **CHOCK THE TRAILER WHEELS** to be double sure. Do not use trailer brakes as parking brakes.

AIRSTREAM CLASSIC TRAILER OWNERS MANUAL

Backing Up

In BACKING UP the important thing to remember is to DO EVERYTHING SLOWLY and to correct immediately if you see the trailer turning the wrong way. Concentrate on the rear of the trailer. With your tow vehicle and trailer in a straight line, back up slowly and turn the bottom of the steering wheel in the direction you want the trailer to go. Watch out the window or in the mirror until the rear of the trailer is pointing in the desired direction. Your tow vehicle will be following the trailer in an arc. Straighten the tow vehicle and trailer by turning the steering wheel more sharply, and then when they are in line, straighten the steering wheel.

ALWAYS TRY TO BACK TO YOUR LEFT BECAUSE THE VISIBILITY IS MUCH BETTER. (See Illustration) When you don't make it on the first try it is usually much easier to pull forward to your original position and start over.

If your spouse or traveling companion normally directs you when backing they should position themselves forward of the tow vehicle so the driver can easily see them. Their directions should always indicate to the driver the direction the rear of the trailer should go. A little practice in a parking lot with the person giving directions can save a lot of frustration when backing into a campsite.

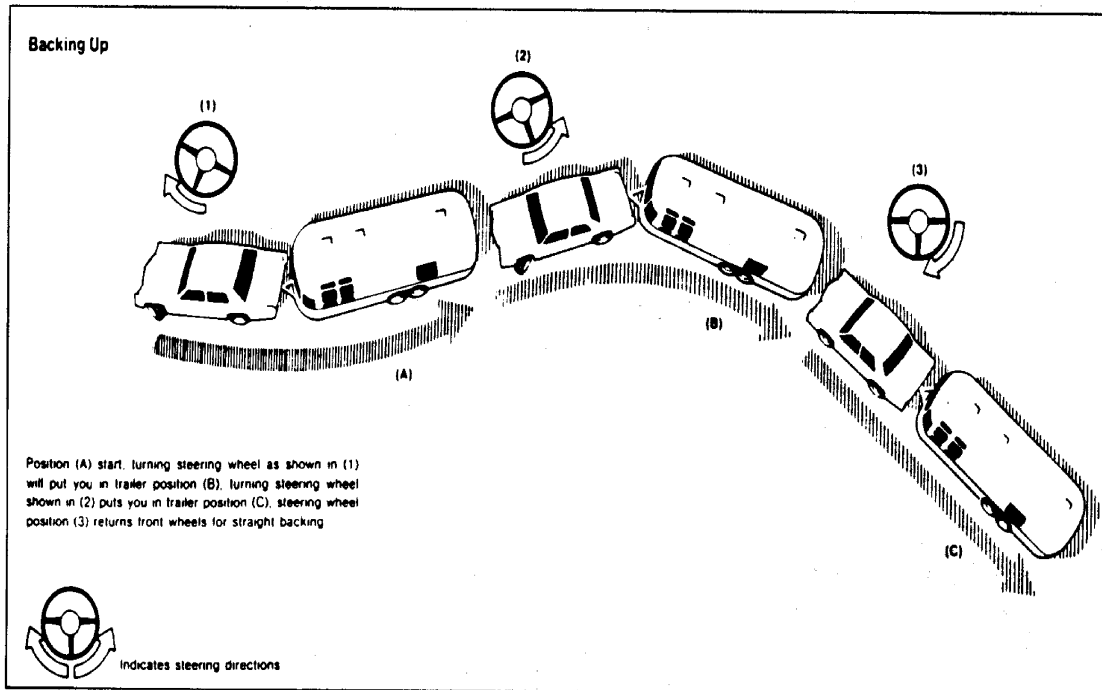

AIRSTREAM CLASSIC TRAILER OWNERS MANUAL

SUGGESTED PRE-TRAVEL CHECK LIST

Interior

1. Turn off water pump switch.
2. Check battery water level.
3. Close windows and vents.
4. Lock all interior cabinet doors.
5. Latch refrigerator door. (Seal containers first.)
6. Hold down or stack securely all loose, hard and sharp objects.
7. Fasten sliding and foldette doors.
8. Drain toilet bowl.
9. Turn off interior lights.
10. Set table in upright position.
11. Pull up or retract step.
12. Lower blinds.
13. Secure and lock the main door.

Exterior

1. Disconnect and slow the electrical hookup cord, the sewer hookup hose (flush out), and the water hookup hose.
2. Turn off gas at LP tanks.
3. Retract stabilizing jacks.
4. Check Hitch: It must be properly attached.
5. Check safety chains and breakaway switch cable.
6. Fully retract jack. Remove and stow jack stand or wood block.
7. Check clearance and stoplights.
8. Check lug nuts.
9. Check tires for correct pressure.
10. Check that TV antenna is properly stowed.
11. Adjust tow vehicle mirrors.
12. Pull forward some 50 ft., test brakes, and check site for forgotten objects and cleanliness.

Home

1. Leave house key with your neighbors.
2. Valuables and important papers should be stored in a safe place.
3. Newspaper, milk and other deliveries should be discontinued.
4. Ask the Post Office to hold your mail for you.
5. Arrange with the telephone company for discontinued or "vacation service".
6. Arrange care for your pets.
7. Your lawn, garden and houseplants should be cared for.
8. Lock all windows and doors securely. Keep shades open for a lived in look.
9. Cover all food to keep out mice and insects.
10. Eliminate all fire hazards Place matches in a tin box or glass jar.
11. Store oil, gasoline and other flammables properly.
12. Destroy all newspapers, magazines and oily rags.
13. Notify police.

AIRSTREAM CLASSIC TRAILER OWNERS MANUAL

Trailer Equipment and Accessories

1. Water hose, 5/8 in. high pressure, tasteless, odorless, non-toxic, (2 -- 25 ft. sections).
2. "Y" connection -- water hose.
3. The sewer hose with clamp.
4. Drain cap with hose drain.
5. Holding tank cleaner and deodorizer.
6. Power cord adapter 30 --amp Capacity.
7. 50 ft. electric cord, 12-3 wire, 30-ampere capacity.
8. 25 ft. electric cord, 10-3, 30-ampere capacity.
9. Woodblocks for leveling.
10. Wheel chocks.
11. Hydraulic jacks.
12. Cross type lug wrench.
13. Torque Wrench
14. Quality tire gauge.
15. Emergency road warning triangle.

Personal

1. Tow vehicle insurance to cover you and your family fully.
2. Avoiding cash. Use Travelers Checks and credit cards.
3. Confirmed reservations.
4. Have sunglasses for everyone.
5. Pack camera and film.
6. Make a checklist of clothing for everyone, and toilet articles

Motoring Essentials

1. Display the tow vehicle and trailer registration properly.
2. Carry drivers license. In Canada, you'll need a non-residence liability insurance card, birth certificate, and/or passport.
3. In Mexico, you must have special auto insurance and a passport.
4. Carry an extra set of the ignition and truck keys in a separate pocket, or in your wallet.
5. Keep an operating flashlight with fresh batteries in the glove compartment.
6. Pack the trunk so that you can reach the tools and spare tire without completely unpacking.
7. Keep sharp or hard articles securely packed wherever they may be.
8. Do not packed things in the passenger seating area. You need the maximum space for comfort.
9. WEAR easy wash, drip-dry traveling clothes.
10. Do not make your vacation trips a mileage marathon. Stop and relax frequently.
11. Carry a first-aid kit.
12. Carry your pets dish, food, leash, and health and registration papers.

AIRSTREAM CLASSIC TRAILER OWNERS MANUAL
NOTES

AIRSTREAM CLASSIC TRAILER OWNERS MANUAL

CAMPING

SAFETY

As always, safety should be one of your top priorities. Make sure you, and everyone traveling with you, can operate the main door and exit window rapidly without light. Contemplate other means of escape in case the designated exits are blocked.



WARNING: The escape windows(s) can be identified by their red release handles. Lifting up both latches, then turning the latches toward the center releases the escape window. Remove the screen. A loop is provided in the SCREEN RETAINING SPLINE so it can be rapidly removed. Push out on the glass and it will swing clear. The window operation should be checked each trip and the latches lubricated with WD-40 or equivalent every six months.



WARNING: At each campsite make sure you have not parked in such a manner as to block the operation of the escape window by being too close to trees, fences or other impediments. Scenic views are one reason for traveling, but don't park so the beautiful lake or steep cliff is just outside your escape window.



WARNING: Read the directions carefully on the fire extinguisher. If there is any doubt on the operation, you and your family should practice, then replace or recharge the extinguisher. You will find your local fire department will be happy to assist you and answer any questions.



WARNING:

Don't smoke in bed.

Keep matches out of reach of small children!

Don't clean with flammable material!

Keep flammable material away from open flame!

We have all heard these warnings many times, but they are still among the leading causes of fires.

Other safety information on the LPG system of your trailer is located in the plumbing section of this manual.

AIRSTREAM CLASSIC TRAILER OWNERS MANUAL

OVERNIGHT STOP

Airstream owners have parked virtually every place imaginable from filling stations to farmlands. In time you'll develop a knack for spying wonderful little roadside locations by turning off the main highway and exploring.

There are many modern parks including State, County and Federal parks with good facilities where you might obtain hookups of electrical, water and sewer connections. Directories are published which describe in detail these parks and tell what is available in the way of services and hookups.

On overnight or weekend trips chances are you will not use up the capacity of the sewage holding tank, deplete the water supply, or rundown the battery which supplies the 12 volt current.

On a longer trip, when you have stayed where sewer connections and utility hookups were not available, it will be necessary for you to stop from time to time to dispose of the waste in the holding tank and replenish the water supply. Many gas stations (chain and individually owned) have installed sanitary dumping stations for just this purpose. Booklets are available which list these dumping stations.

When stopping for the night, your Airstream is built to be safely parked in any spot that is relatively level and where the ground is firm. Your facilities are with you. You are self-contained. Unless the tow vehicle is needed for transportation, it is not necessary to unhitch.



WARNING: Do not park in a manner that would prevent the escape windows from opening.

Try to pick as level a parking spot as possible. Stabilizing jacks or blocks probably won't be required for an overnight stay unless you extend a slide out room. However, if you put the jack pad on the hitch jack and run the hitch jack down to take the weight off the car's springs it will provide some stability. If you must park on a slope, **PARK FACING DOWNHILL**. It is easier to level the trailer this way.

SLIDE OUT ROOM

The trailer should be level prior to extending the slide out room. The front stabilizing jacks **MUST** be deployed. If the front jacks aren't down when the room is extended the side to side imbalance will twist the body of the trailer if it's only supported by the front hitch jack. Please read the complete leveling and stabilizing instructions in the Extended Stay part of this section.

Once leveled and stabilized, locate the switches to operate the room. They are black and located on the interior wall just forward of the room. The left switch, marked lock downs, must be used first. The lock downs are the large paddle latches on each end of the room. Depress the switch to the unlock position and hold. You will see the paddle latch on the forward end of the room retracting. Hold the switch down until the panels are completely retracted and you hear the operating motors just start to strain. The motors are thermal protected so you won't have to worry about damaging them.

WARNING! PLEASE READ

LEVEL AND STABILIZE UNIT USING HITCH JACK AND STABILIZER JACKS PRIOR TO OPERATING SLIDE-OUT ROOM. FAILURE TO LEVEL UNIT MAY CAUSE THE ROOM TO OPERATE IMPROPERLY OR CAUSE DAMAGE.

MAKE SURE THERE IS ADEQUATE CLEARANCE TO OUTSIDE OBJECTS BEFORE SLIDE-OUT ROOM IS EXTENDED.

TO PREVENT ACCIDENTAL INJURY, STAND CLEAR OF SLIDE-OUT ROOM WHILE ROOM IS IN MOTION.

REMOVE TRAVEL LOCKS BEFORE ATTEMPTING TO OPEN SLIDE-OUT ROOM.

NEVER ATTEMPT TO MOVE TRAILER WITH ROOM EXTENDED.

INSTALL TRAVEL LOCKS PRIOR TO TRAVEL.

TRAVEL LOCKS TO BE POSITIONED & ADJUSTED PROPERLY TO HOLD ROOM FIRMLY IN POSITION FOR TRAVEL.

AIRSTREAM CLASSIC TRAILER OWNERS MANUAL

EXTENDED STAY

Making a long trip in your Airstream is not very different from making a weekend excursion. Since everything you need is right at hand, you are at home wherever you go. When packing for an extended trip take everything you need, but only what you need.

When you plan to stay in the same place for several days, weeks or months, you will want your trailer to be as level and steady as possible. Check the attitude with a small spirit level set on the inside work counter or the trailer hitch "A-Frame". (See Diagram Below) If a correction is necessary then **YOU MUST LEVEL FROM SIDE TO SIDE FIRST** This can be done easily by backing the trailer up one or more 2" x 6" boards. (See Diagram) We do not recommend placing tires in a hole for leveling.

LEVEL FROM FRONT TO REAR by disconnecting the hitch from the tow vehicle, putting the jack pad under the hitch jack and adjusting the jack up or down until you are level. Block or chock the wheels to keep the trailer from rolling. Use **STABILIZING JACKS** at all four corners as shown in the diagram to eliminate the natural spring action of the axles. **Optional STABILIZING JACKS, whether manual or power, should only be used to stabilize trailer.**

! WARNING: Whenever the trailer must be lifted with a jack, as when changing a tire or leveling on very rough terrain, **ALWAYS PLACE THE LIFTING JACK UNDER THE MAIN FRAME RAIL.** A label is provided to indicate the proper position for the jack. **NEVER USE STABILIZING JACKS TO LIFT THE TRAILER.**

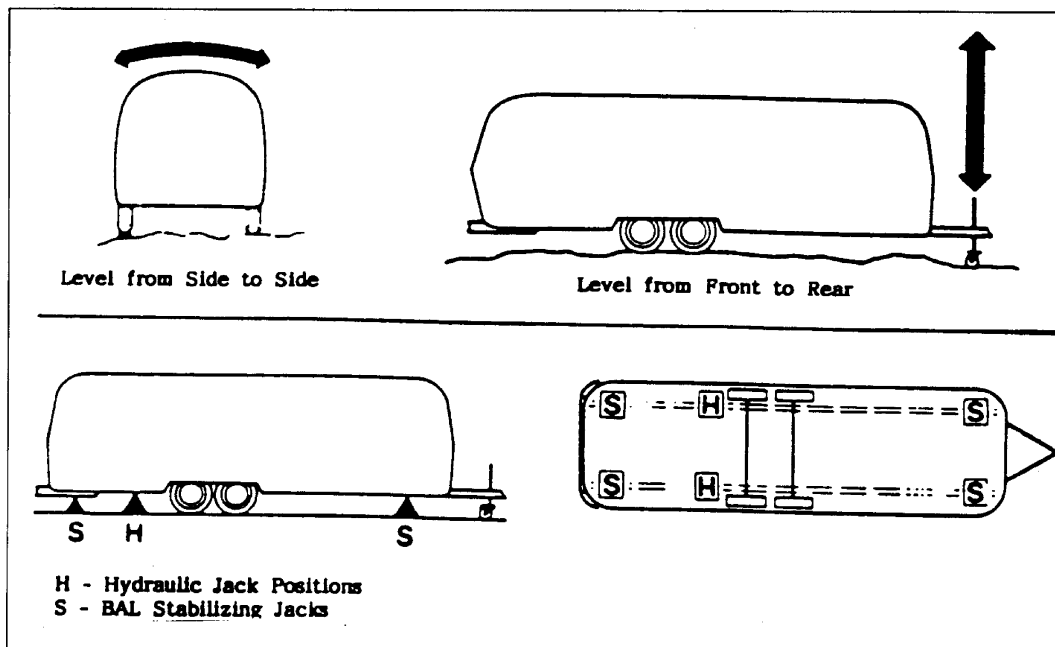

AIRSTREAM CLASSIC TRAILER OWNERS MANUAL

HOOK UP TO WATER (See Fig. 3) by attaching a ½” minimum high-pressure water hose to the city water service.

The power cord is stored in the lower roadside rear storage compartment. The cord is stored on a tray that can be slid out and dropped down for ease of use.

The power cord is plugged into City Power Service.

Hook your WATER DRAIN HOSE (See Fig. 5) in the SEWER DISPOSAL FACILITY and attach to the drain outlet in your trailer.

Turn on gas supply. Light the range and oven pilots. Turn on the water heater, refrigerator and furnace.

When you stay for an extended period where electric or water hookups are not available, you must make regular checks on the condition of your 12-volt battery. Hooking up the tow vehicle/trailer electrical connector and running the tow vehicle engine at a fast idle. 45 minutes per day should provide about 3-4 hours of power. Carry drinking water in a clean bucket to refill your tank. When your waste tank nears capacity move to a dumping location.

The CABLE TV and TELEPHONE hookups are located in the power cord storage compartment. The interior telephone jack will be located in the bedroom over the center nightstand in twin bed models and in the hanging wardrobe on the roadside of the bed in the double models.



WARNING: Check your escape window(s) to make sure they will open completely. Also make sure the terrain under the window is suitable for rapid exiting.

AIRSTREAM CLASSIC TRAILER OWNERS MANUAL

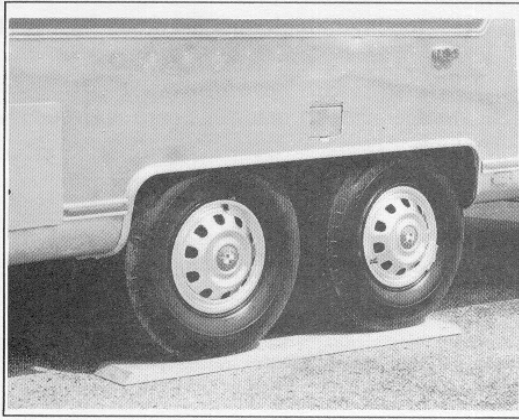

Fig. 1 - Trailer Leveling

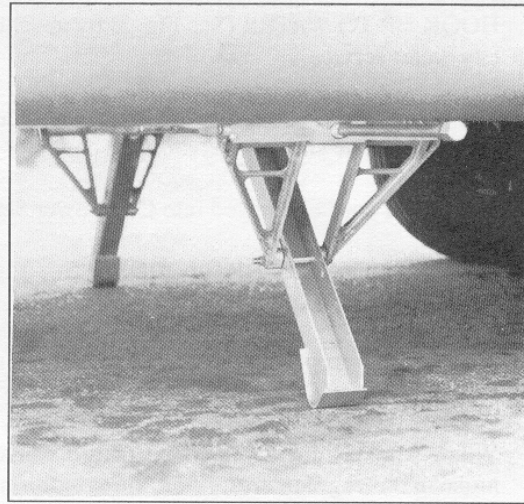

Fig 2 - B.A.L. Stabilizing Jack

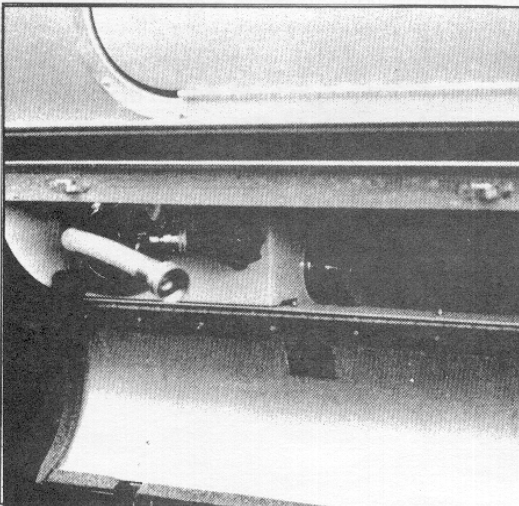

Fig. 3 - City Water Hook-Up

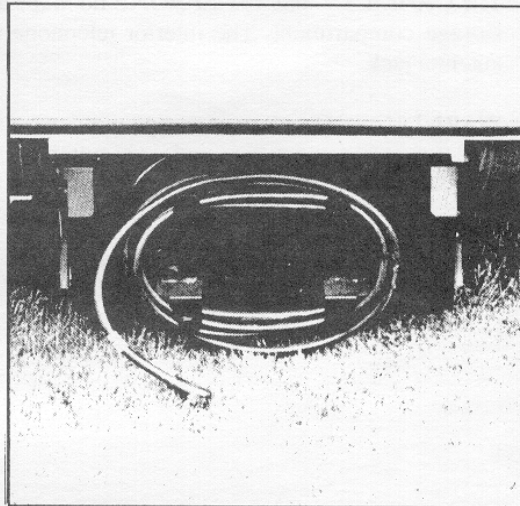

Fig. 4 - 120 Volt Electrical Cable

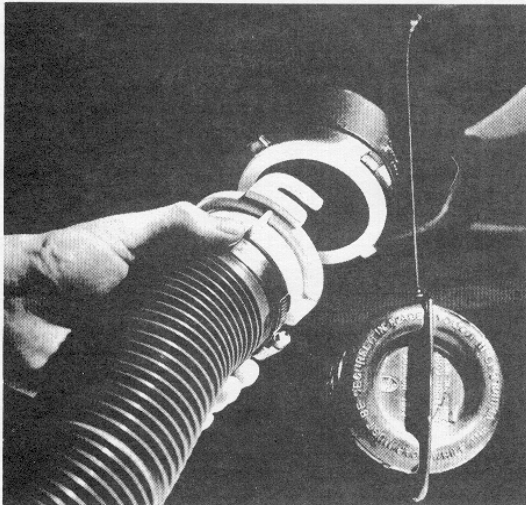

Fig. 5 - Waste Drain Hose Hook-Up

AIRSTREAM CLASSIC TRAILER OWNERS MANUAL

WINTER TRAVELING

Traveling in sub-freezing temperatures will require certain precautions to protect the plumbing system and your personal belongings from being damaged by freezing.

Whenever possible the heat should be kept on at a constant temperature. It is easier for the furnace to keep a constant room temperature than for the trailer temperature to be allowed to drop to 50 degrees Fahrenheit then attempt to raise it to room temperature.

CAUTION: If you have the optional air conditioners with heat pump they should not be used if ambient temperatures remain below 25 degrees F for more than 12 hours.

Only the furnaces are ducted to provide heat to tanks and plumbing to prevent freezing.



WARNING: Always shut off the LP gas and be sure all flames are extinguished before gasoline is added to the tow vehicle.

Some states do not allow LPG to be turned on while moving. While traveling in these states you must use your common sense. How cold is it? How long will it be before you can turn the heat back on? Is the temperature dropping or raising? Remember, when towing at 50 MPH the wind chill factor will cause the interior of the trailer to cool much faster than a trailer that is parked.

When parked in sub-freezing temperatures make sure you keep a full supply of LP gas and plug into a 110 volt power source whenever possible. A fully charged battery will not last more than 8 to 10 hours if the furnace is running almost constantly and 110-volt power is not available.

Leave cabinet doors, wardrobes and bed doors partially open to allow warm air to circulate around plumbing lines and fixtures. Insulate and/or wrap your exterior water lines with heat tape.

CAUTION: The exterior water service line to the utility compartment is in an unheated section of the trailer and must not be used in below freezing conditions.

A water valve is provided so the water can be turned off to the line. The exterior water service shut off valve is located in the lavatory cabinet. Close the shut off valve and open the water service for a few seconds to drain the line and prevent freeze damage.

CONDENSATION

It is also important to guard against excessive humidity. Cold air will not hold the moisture, and sweating will occur around window frames, on window glass and may occur where structural beams connect the inner and outer walls of the trailer. The best method to combat sweating is to hold water vapor producing functions to a minimum. Boiling water, baths, showers, washing dishes are necessities, but usually can be reduced. Opening windows just slightly on opposite sides of the trailer will also help alleviate the problem. In severe conditions you may want to use a small dehumidifier to aid in reducing condensation.

NOTE: The Airstream trailer is built as a recreational vehicle and is not intended as a permanent dwelling or for more than temporary use in sub-freezing temperatures.

AIRSTREAM CLASSIC TRAILER OWNERS MANUAL
NOTES

AIRSTREAM CLASSIC TRAILER OWNERS MANUAL

EXTERIOR

Cleaning

As a general rule of thumb we recommend the trailer be washed about every four weeks and waxed in the spring and fall. In industrial areas cleaning and waxing should be done on a more frequent schedule.

CAUTION: ABRASIVE POLISHES OR CLEANING SOLVENTS SUCH AS AUTOMATIC DISHWASHER DETERGENTS OR ACID ETCH CLEANERS. ARE TOO STRONG AND SHOULD NEVER BE USED. RINSE ALL GRIT FROM SURFACE PRIOR TO WASHING. DO NOT USE WIRE BRUSHES, STEEL WOOL, ABRASIVES OR OTHER SIMILAR CLEANING TOOLS THAT WILL MECHANICALLY ABRASE THE COATING SURFACE. ALWAYS TEST A SMALL INCONSPICUOUS AREA FIRST.

ALWAYS CLEAN YOUR TRAILER IN THE SHADE OR ON A CLOUDY DAY WHEN THE ALUMINUM SKIN IS COOL. Use soft rags or wash mitts always moving lengthwise with the grain of the trailer. NEVER rub hard on the coating. Oil, grease, dust and dirt may be removed by washing with a 5% solution in water of commonly used commercial and industrial detergents. Cleaning should be followed by a thorough clean water rinse. Drying the unit with a chamois or a soft cloth may prevent spots and streaks. WHEN WASHING OR WAXING YOUR TRAILER, ALWAYS WIPE "WITH" THE GRAIN OF THE METAL.

After cleaning and drying, a good grade of nonabrasive automotive paste or liquid wax will increase the life of the finish, especially in coastal areas where the finish is exposed to salt air or in polluted industrial areas. It will also protect the shell from minor scratches and make subsequent cleaning easier.

It is important to remove sap, gum, resin, asphalt, etc. as soon as possible after they appear by washing and waxing. Sunlight and time will bake-harden these materials making them almost impossible to remove without heavy buffing. If a substance is found on the coating that cannot be removed by normal washing procedures, Airstream recommends using DX 330 Acryli-Clean made by PPG Industries. Follow all directions and warnings on the product container. Acryli-Clean should be used by trained personnel only, using the proper equipment under controlled conditions. Use the Acryli-Clean as sparingly as possible to remove glue, tar, and other similar substance. Rinse with cool water immediately after use.

To keep your trailer looking new, paint the "A" frame, LPG tanks, and rear frame periodically. The Limited option includes gold plated medallions. Use mild soap and water on a soft cotton cloth to clean. Gold is a soft metal and will scratch, If that doesn't work, use a mild metal polish such as PEAK METAL POLISH applying lightly with a clean soft cotton cloth.

It is recommended that the caulking and sealant used in external seams and joints such as end shell segments and around window frames, light bezels, beltline and rub rail molding, etc. be checked regularly. If this material has dried out and become cracked or checked, or if a portion has fallen out, it should be replaced with fresh material to prevent possible rain leaks. Caulking and sealing material is available from your Airstream dealer.

Precautions should be taken to prevent excessive sealant from getting on the coated surfaces. Remove excessive sealant before it cures using DX 330 Acryli-Clean made by PPG Industries as explained above.

CAUTION: It may be possible for solvents other than those recommended to extract materials from sealants that could stain the coated surface or could prove harmful to the sealants; therefore, these possible effects must be considered. Test a small area first.

AIRSTREAM CLASSIC TRAILER OWNERS MANUAL

Main Door

CAUTION: When towing, the door lock and dead bolt must be secured. If it is not locked, the constant vibration of travel may cause the door to open with possible damage.

Screen Door

The screen door secures to the main door by means of a slide bolt type latch. It can be operated independently by releasing the slide bolt and swinging the screen door away from the main door.

Step

To operate the step, lift up on the latch bar and the step will drop down.



WARNING: Once the steps are lowered, press down on them to make sure they are secure in their notches.

CAUTION: Never travel with step lowered or extended

Exterior Windows

The windows in your trailer are safety glass. To open: release the two lever locks at the bottom, lift up on the two side operator handles until the window is in the desired position, and place the operators into one of the three positioning slots on the side of the frame. To lock the windows reverse this position

Note: Some windows are designed as an emergency escape exits. The rubber Spline holding the screen in place is looped so it can be pulled out in one swift motion.

You and all your family should practice escape procedures so they can be rapidly accomplished even in total darkness.

WARNING: Never park your trailer so the escape windows cannot be easily used for emergency exits.

Clean your trailer windows the same way you clean the windows in your home. Clean the seals with a damp cloth or mild detergent every three to six months, taking care not to use strong solvents, as they will damage the seals. A coat of natural silicone lubricant applied after the seal has dried will keep it flexible. Spread the lubricant evenly with a brush or finger, working it into the surface.

This is a good practice for all rubber seals in your trailer. For replacement of a damaged window contact an Airstream Service Center.

Your PLASTIC SCREENS are easy to maintain. Clean occasionally with a damp cloth.

Note: They will melt at the point of contact if touched by a cigarette.

Awnings

Complete instructions have been provided with your awning. You should make sure your traveling companion is familiar with the operation of the awning. If a sudden wind should come up, or if high wind is forecast, the awning should be retracted and stowed.

AIRSTREAM CLASSIC TRAILER OWNERS MANUAL

Chassis

The standard RECOMMENDED HITCH BALL HEIGHT for your Airstream is 18 ¾" on all models except the slide outs which are 19.75". If you plan long trips with the trailer heavily loaded you should check your trailer, after loading, to determine the optimum height. To check, park the trailer on a level surface and crank the front jack up or down until the measurement from the frame to the ground is the same front and rear. Measure from the ground to the upper surface of the hitch ball coupler. Add one inch to this figure when setting the ball height on the tow vehicle to allow for the suspension settling under the added weight.

 **WARNING** - ALWAYS OPEN LATCH HANDLE BEFORE INSERTING BALL

OPERATION INSTRUCTIONS

1. To open - slide forward and pull up to open latch before inserting ball.
2. Place coupler on ball of same diameter as coupler and of same or greater capacity.
3. When ball is completely nested in socket, push top of latch handle rearward until handle snaps into closed position. (Figure 2)
4. Extend jack to ground and lift car/trailer combination 2-4" to insure coupler is securely attached to tow ball. Retract jack before towing.
5. Insert padlock through hole in handle for theft prevention.

POWER JACK

A switch located on the bottom of the housing operates the power jack. When the jack is fully extended or retracted internal limit switches automatically shut off the motor.

Should an electrical failure occur, remove the power head by loosening the two Allen set screws. The jack post may now be operated manually by inserting the emergency handle into the coupling on top of the post.

Replacing Power Head

It is essential that the following procedure be used before the power head is replaced on the post.

1. With 12 volts connected, ground the power head to trailer "A" frame. Operate main switch in "post retracting direction" until the motor stops automatically.
2. Using emergency handle, crank post clockwise by hand until fully retracted, then turn crank one turn counterclockwise.
3. Replace head on post and make sure that drive pin is engaged with post coupler. Tighten Allen set screws.

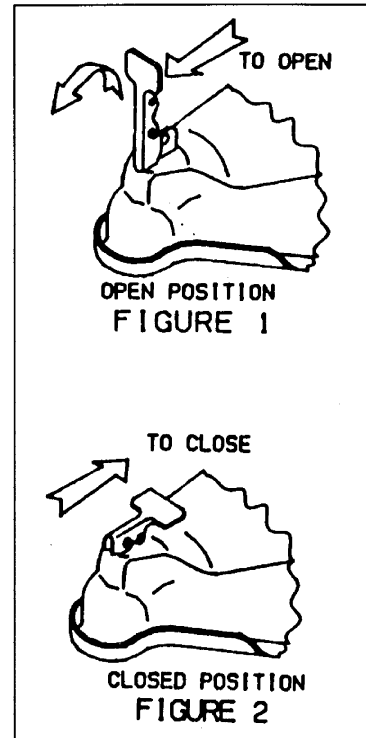

AIRSTREAM CLASSIC TRAILER OWNERS MANUAL

Maintenance

1. Every two years remove screws and cover and check grease condition. Use HMP grease similar to lubricate 630AA and spread on gear teeth, Grease is not required on the nylon timing gears. No internal lubrication of the post is required, but an occasional external application of a silicone or WD-40 spray lubricant on the inner tube of the post when extended is permissible.

2. Before replacing the cover ensure that the plate and limit switch unit are located correctly.

3. Apply a little sealing compound around the mating surface of the gear cover and replace screws tightening them diagonally. Check synchronization if head has been removed from the post.

4. A little penetrating oil on the Allen setscrews occasionally will help prevent corrosion and difficult removal.

Note: Leave tow vehicle transmission in neutral when lifting both units. Dolly wheels are not recommended. Always retract stabilizing jacks before using your Super Jack under load.

SUPER POWER JACK ASSEMBLY

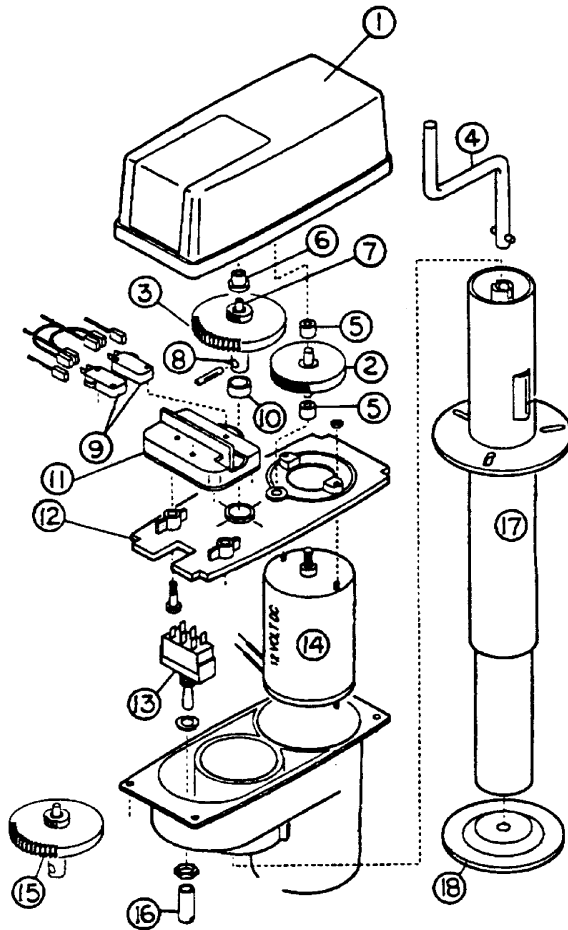

- 1) Cover, Super Jack
- 2) Gear, fiber, Super Jack
- 3) Drive gear, Super Jack
- 4) Crank handle, manual, Super Jack
- 5) Bushing, bronze, Super Jack
- 6) Bushing, flange, Super Jack
- 7) Gear, pot/reed, Super Jack
- 8) Shaft, Super Jack
- 9) Micro switch, Super Jack
- 10) Bushing/bronze, 7/16, Super Jack
- 11) Limit switch assembly, Super Jack
- 12) Center plate, Super Jack
- 13) Switch, toggle, Super Jack
- 14) Motor, 12v, Super Jack
- 15) Drive gear assembly, Super Jack
- 16) Switch cover, Super Jack
- 17) Jack post, Super Jack
- 18) Foot, Super Jack

AIRSTREAM CLASSIC TRAILER OWNERS MANUAL

TIRES

Your trailer is equipped at the factory with name brand trailer tires. Airstream dealers cannot make adjustments to tires. A dealer who handles that particular brand must do this. If you ever have tire problems check the local telephone directory for the nearest dealer.

To get the maximum performance from your tires check the air pressure often, but only when the tires are cool. Never bleed out air immediately after driving. Recommended tire pressures vary with tire type and size. For pressures refer to the SPECIFICATION TABLE.



WARNING: It is also important to periodically check on the tightness of lug nuts. On aluminum wheels they should be tightened to a torque of 85 ft. pounds. Steel wheels should be torque to 95 Ft. Lbs. Care should be taken at all times when handling the wheel because of possible damage to its appearance.

NOTICE! CHECK WHEEL LUGS

1. On first trip, tighten wheel lugs at the start, and at 25, 50, and 100 miles.
2. There after, check wheel lugs before each trip.
3. Following winter storage, check before beginning a trip. Following excessive braking, inspect wheel lugs

Try to park out of the sun whenever possible when in warm climates. In desert regions use tire covers to prevent ultra-violet deterioration to tires.



TIRE CHANGING

To CHANGE A TIRE with a jack see the label affixed to the underbelly to the rear of the wheels. This label, says JACK with an arrow and points to a plate riveted to the mainframe rail where the jack head must be placed. A flat tire may also be changed without the aid of a jack. Drive the unit up on a ramp 8' wide, 6" high, and about 3 feet long at its base. Position the good tire on the ramp. This will raise the flat tire clear of the ground.



WARNING: Never attempt to change any tire without securely chocking remaining wheels. Never position yourself in a manner where a raised trailer can come down on you if it should become dislodged from a jack or ramp.

All tire and wheel assemblies are balanced at the factory. Be sure to rebalance the tire and wheel assemblies each time a tire is changed.



WARNING: When removing aluminum-forged wheels from spindle, it is very important to mark them to assure the wheel is placed in the same position of the drum when reinstalling. If the aluminum-forged wheel is to be mounted on a different drum it is important to sand all loose corrosion from the mating surfaces.

AIRSTREAM CLASSIC TRAILER OWNERS MANUAL

In an emergency remove the flat tire. The independent suspension Of the Rubber torsion Axle allows four or six wheel units to be safely towed on three or five wheels for a short distance (100 miles maximum) and only at a low speed (30 MPH).

Be especially cautious in crossing holes or dips in the road. Under these circumstances it is good practice to set your rear view mirrors so that you can observe your tires at all time.

Tips on Tire Care

Any tire, no matter how well constructed, may fail in use as a result of punctures, impact damage, improper inflation or other conditions resulting from use. Tire failures may create a risk of property damage or personal injury. To reduce the risk of tire failure we strongly recommend the following:

1. Check the pressure in your tires, including your spare, at least monthly when the tires are cool (after the vehicle has stopped three hours and then driven less than one mile.) Do not reduce pressure when tires are hot. Use a tire gauge to check pressure and maintain it at the recommended level.
2. Never overload your tires. The maximum load carrying capability of your tires is molded on the sidewall of the tire.
3. Check your tires frequently for scrapes, bulges, separations, cuts or snags resulting from use. See your tire dealer immediately if any such condition is discovered.
4. Never operate your vehicle in excess of lawful speeds or the maximum speeds justified by driving conditions, or in excess of speeds recommended for the tire you are using.
5. Make every effort to avoid running over objects that may damage the tire through impact or cutting, such as chuckholes, glass, metal, etc.
6. Never drive on smooth tires. Tires should be removed when $2/32$ nds inch of tread depth remains. In most states it is illegal to drive with less than $2/32$ nds inch remaining tread depth.

AIRSTREAM CLASSIC TRAILER OWNERS MANUAL

TIRE ROTATION

(10,000-mile intervals)

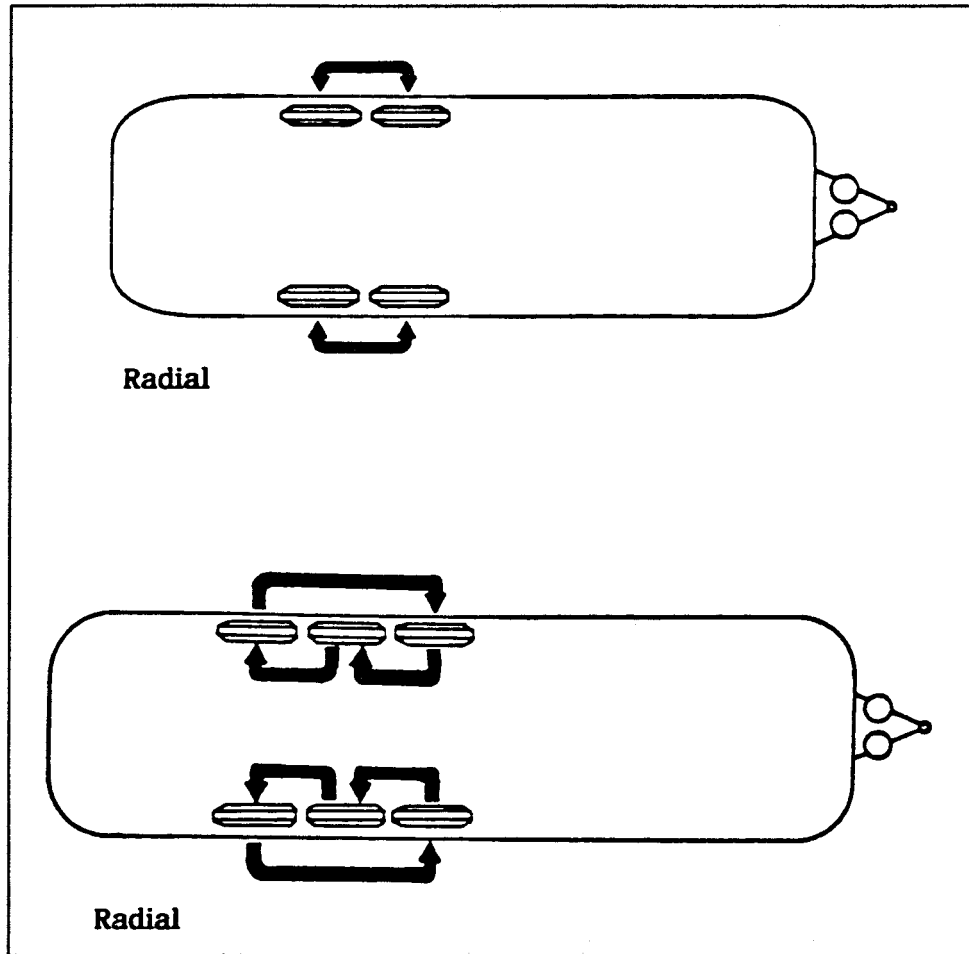

SPARE TIRE

The spare tire for Airstreams is stored under the front of the trailer. The front handle of the tire carrier is a one-inch tube protruding out from under the front A-frame on the curbside. It is secured by a bracket and bolt along the inside of the A frame rail. Removing the bolts allows the front on the tire carrier to be lowered and the spare tire removed.

AIRSTREAM CLASSIC TRAILER OWNERS MANUAL

AXLE AND RUNNING GEAR ASSEMBLY

Each Airstream RUBBER TORSION axle is aligned during manufacturing, and double-checked on a random basis. Alignment after delivery is the customer's responsibility.

Hitting chuck holes or rough railroad tracks while going straight will only cause misalignment after the tire has been struck many repetitive times. Of course, a deep enough hole can affect the alignment immediately.

The worse culprit is a curb because they are normally struck at an angle. Surprisingly rear axles are occasionally damaged when people are attempting to park beside a curb and are backing up their trailer.

As you look under your trailer is it normal for the axle to be bent up in the middle. This bend is how the camber is obtained.

Toe-in is built into the axle by very slight bends in the axle tube on each end.

If tire wear ever indicate misalignment check with your dealer for the nearest location having the proper equipment.

CAUTION: Never allow heat to be applied to the axle tube since the rubber providing the spring torsion action will be severely damaged.

Rubber torsion Axle Alignment Specifications

Toe-In each side 1/16"

Tolerance 1/16" + or -

Camber each side ¾ degrees positive

Tolerance ¾ degrees + or -

Wheel Bearing Maintenance

1. Jack trailer at marked jack location pad behind axle on mainframe.
2. Remove hubcap or spindle cover, wheel and tire.
3. Remove cotter pin.
4. Remove dust cap.
5. Remove spindle nut and washer.
6. Remove bearings, hub and rotor.
7. Lay down hub and rotor with inside grease seal down. Knock out inner bearing and grease seal using wood or plastic dowel and hammer.
8. Clean all parts thoroughly with kerosene.
9. Check all bearings and races for chips or roughness of any kind. Any damaged component must be replaced.
10. Pack bearing with a good grease (No 2 grade-265 ASTM penetration or equivalent).
11. Install inner bearing.
12. Install new grease seal in hub or rotor using wooden or rawhide mallet.
13. Install hub and drum on spindle.

AIRSTREAM CLASSIC TRAILER OWNERS MANUAL

14. Install outer bearing.

15 Install washer and spindle nut.

16. While rotating the wheel, tighten the spindle nut with a 12" wrench until there is a slight tension. Then back off one notch and install cotter pin. There should now be from .001" to .010" endplay in hub. If not, back off one notch.

17. Check the lug nuts every 25, 50 and 100 miles for the first 100 miles of travel. Aluminum wheels should be tightened to torque of 85 ft. lbs and steel wheels to 95 ft. pounds.

When greasing bearings by hand, place a glob of grease in the palm of one hand and push the large end of the bearing down into the grease (see illustration). Keep turning the bearing around and forcing it down through the grease until the grease is extruded up through the opposite end. Wipe the extra grease in your hand around the outside of the bearing. It's not necessary to fill the hub and dust cap with grease.

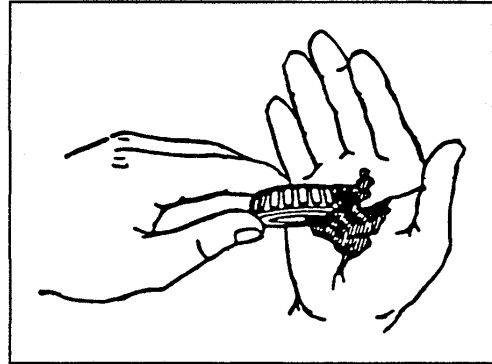

AXLE AND RUNNING GEAR ASSEMBLY

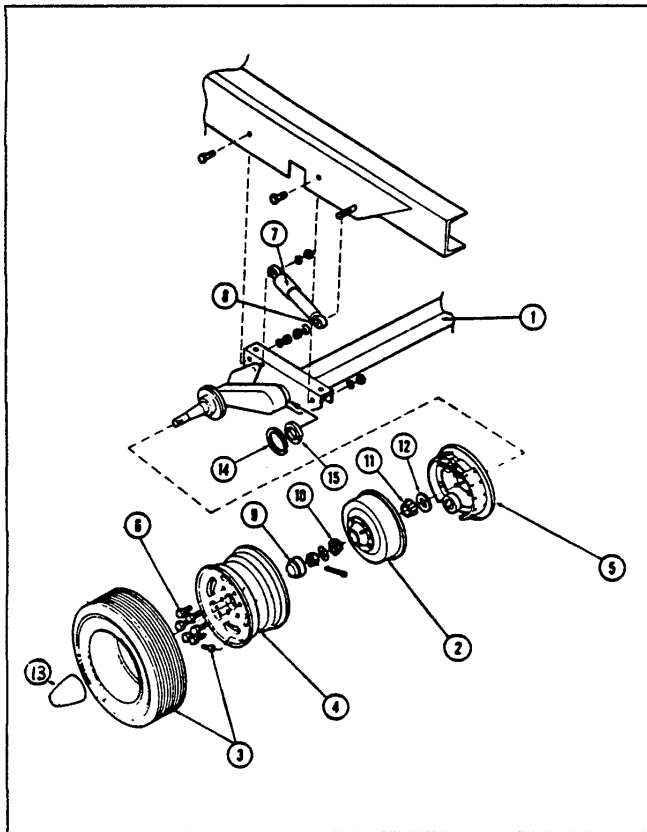

1. Rubber torsion Axle
2. Unicast Hub and Drum
3. Valve Stem
4. Wheel
5. Brake Set
6. Lug Nuts
7. Shock Absorber
8. Shock Absorber Bushing
9. Dust Cover
10. Outer Bearing
11. Inner Bearing
- 12 Grease Seal
13. Spindle Cover
- 14 Retainer Bearing
15. Nylon Bushing

AIRSTREAM CLASSIC TRAILER OWNERS MANUAL

ELECTRIC BRAKES

A CONTROLLER installed in your tow vehicle will synchronize the trailer brakes with your tow vehicle brakes. It is designed to apply the trailer brakes whenever the tow vehicle brakes are applied.

TYPICAL ELECTRONIC CONTROLLER

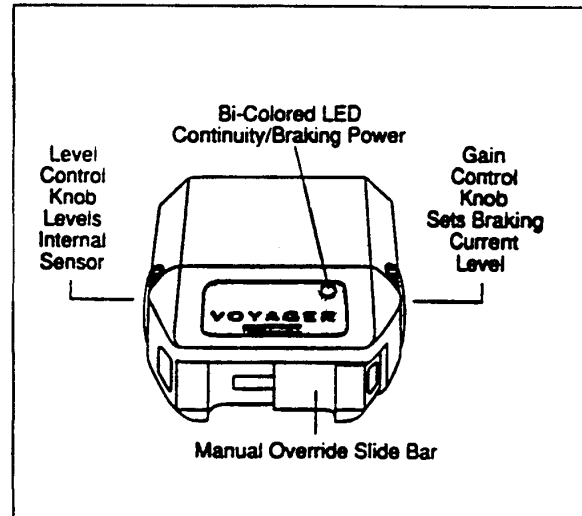

ELECTRONIC CONTROLLERS are inertially activated. The controller senses deceleration and generates an output, which reflects the inertia sensed. When you are stationary, the controller does not apply the brakes unless the manual slide bar is activated.

NOTE: Study all material provided with your particular brake control. If you don't understand the information, have the installer explain the information to you or call the manufacturer of the controller.

In THE EVENT OF AN ACCIDENTAL SEPARATION of the tow vehicle and trailer, the BREAKAWAY SWITCH will set and lock the trailer brakes for a sufficient length of time to stop the trailer. The switch is activated when the wire attached to it and to the tow vehicle pulls out the small pin in the front of the unit. THIS PIN SHOULD BE PULLED OUT, LUBRICATED WITH LIGHT HOUSEHOLD OIL AND REPLACED EVERY 90 DAYS.

To prevent corrosion within the breakaway switch, pull the switch's pin straight forward and spray the inside of the switch through the hole with an electric contact cleaner (such as Spra-Kleen) and reinsert the pin. A drop of light household oil on the groove near the base of the pin will allow the pin to operate freely. WHEN THE TRAILER IS CONNECTED TO THE TOW CAR, THE BREAKAWAY SWITCH LOOP SHOULD BE ATTACHED TO THE PERMANENT FRAME OF YOUR HITCH. When disconnecting trailer from tow vehicle remove wire loop from the frame. DO NOT REMOVE THE PIN FROM THE SWITCH FOR AN EXTENDED PERIOD OF TIME BECAUSE THIS WILL APPLY THE TRAILER BRAKES AND POSSIBLY DAMAGE THE BRAKE MAGNETS AND RUN THE BATTERY DOWN.

CAUTION: Do not use breakaway switch for parking brake.

AIRSTREAM CLASSIC TRAILER OWNERS MANUAL

HOW ELECTRIC BRAKES WORK

The electric brakes on your trailer are similar to the drum brakes on your tow vehicle. The basic difference is that your automotive brakes are actuated by hydraulic pressure while your electric trailer brakes are actuated by an electromagnet. With all of the brake components connected into the system, the brakes will operate as follows: (See Figure A).

When electrical current is fed into the system by the controller, it flows through the electro- magnets in the brakes. The high capacity electromagnets are energized and are attracted to the rotating armature surface of the drums, which moves the actuating levers in the direction that the drums are turning. The resulting force causes the actuating cam block at the shoe end of the lever to push the primary shoe out against the inside surface of the brake drum. The force generated by the primary shoe acting through the adjuster link then moves the secondary shoe out into contact with the brake drum.

Increasing the current flow to the electromagnet causes the magnet to grip the armature surface of the brake drum more firmly. This results in increasing the pressure against the shoes and brake drums until the desired stop is accomplished.

HOW ELECTRIC BRAKES HELP

Electrically actuated brakes have several advantageous features over other brake actuation systems.

1. They can be electrically adjusted to provide the correct braking capability for varying road and load conditions.
2. They can be modulated to provide more or less braking force, thus easing the brake load on the towing vehicle.
3. They have relatively no lag time from the moment the tow vehicle's brakes are actuated until the trailer brakes are actuated.
4. They provide a separate braking system to that of the tow vehicle, which can be of benefit in the event of tow vehicle brake failure.

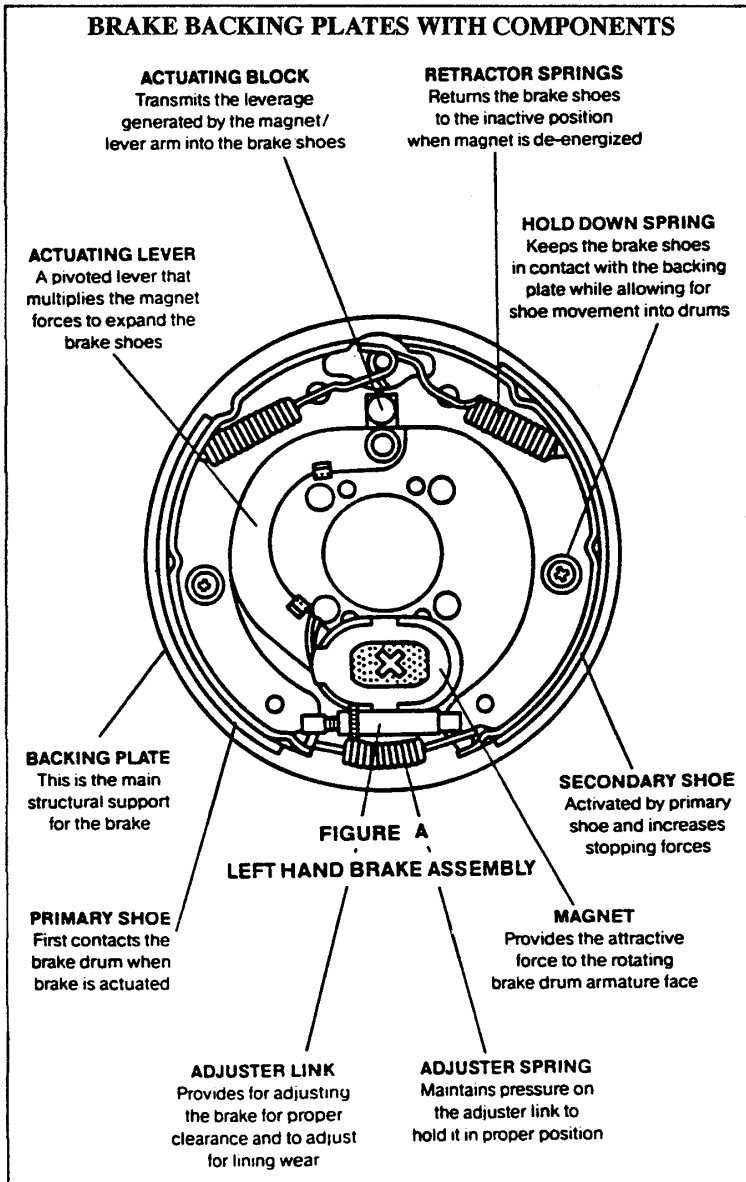

AIRSTREAM CLASSIC TRAILER OWNERS MANUAL

HOW TO USE YOUR ELECTRIC BRAKES PROPERLY

Your trailer brakes are designed to work in synchronization with your tow vehicle brakes. Never use your tow vehicle or trailer brakes alone to stop the combined load.

Your trailer and tow vehicle will seldom have the right amperage flow to the brake magnets to give you comfortable, safe braking unless you make proper brake system adjustments. Changing trailer load and driving conditions as well as uneven alternator and battery output can mean unstable current flow to your brake magnets. It is therefore imperative that you maintain and adjust your brakes as set forth in this manual, use a properly modulated brake controller, and perform the synchronization procedure noted below.

In addition to the synchronization adjustment detailed below, electric brake controllers provide a modulation function that varies the current to the electric brakes with the pressure on the brake pedal. It is important that your brake controller provide approximately 2 volts to the braking system when the brake pedal is first depressed and gradually increase the voltage to 12 volts as brake pedal pressure is increased. If the controller "jumps" immediately to a high voltage output, even during a gradual stop, then the electric brakes will always be fully energized and will result in harsh brakes and potential brake lockup.

Proper synchronization of tow vehicle to trailer braking can only be accomplished by road testing. Brake "lockup, grabbiness, or harshness" is quite often lack of synchronization between the tow vehicle and the trailer being towed, too high of a threshold voltage (over 2 volts), or under adjusted brakes.

Electronic Brake Control

These instructions are for a Tekonsha electronic controller, please read and follow all instructions on your controller carefully before installing or operating the brake control.

Components of a Brake Control

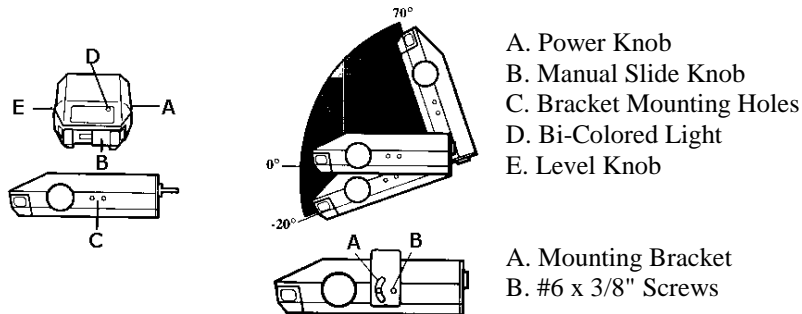

Important Facts to Remember

1. Do not mount or activate RF generating items (cell phones, two way radios) near (less than 12") the brake control.
2. Reversing the connection to a breakaway battery on the trailer will destroy the brake control.
3. Disconnect trailer plug from the tow vehicle prior to testing a breakaway switch, or you may destroy the brake control.
4. The light is:
 - GREEN when trailer is connected.
 - RED when brake pedal or manual is activated and trailer is connected.
5. The GREEN light draws 10 milliampere of current from tow vehicle. It would take over 5,000 hours to drain the tow vehicle battery.
6. The level adjustment is CRITICAL. The level adjustment determines whether automatic braking response is delayed or aggressive.

AIRSTREAM CLASSIC TRAILER OWNERS MANUAL

7. This brake control is activated by inertia. It senses deceleration and generates an output that reflects the inertia sensed. In a stationary state, the brake control will not apply the trailer brakes unless the Manual Slide Knob is actuated.

NOTE: Electronic Brake Controls must be mounted from -20 degrees nose down to 70 degrees nose up. (See above.) Failure to install brake control within these constraints may cause your control to become inoperable.

Leveling the Sensor

After the brake control has been securely mounted the level adjustment must be set.

Electronic brake controls are activated by inertia and require the level to be set properly, or the braking response will be too harsh or ineffective. To properly level the sensor, the trailer and tow vehicle must be parked on a level surface and trailer must be connected to tow vehicle.

1. Connect trailer to tow vehicle, Bi-Colored Light should glow GREEN.
2. Set power knob to maximum by fully rotating clockwise
3. Depress tow vehicle's brake pedal and hold.
4. Rotate the Level Knob counter-clockwise (towards the back of the control) until the Bi Colored Light starts to change colors from GREEN to RED.
5. Carefully rotate the Level Knob clockwise (towards the front of the control) until a shade of ORANGE is visible.
 - Bi-Colored Light should show:
 - DIM ORANGE for a typical setting. BRIGHT ORANGE for an aggressive setting.
 - DIM RED for a more aggressive setting.

NOTE: Range of adjustment for the level knob from DIM ORANGE to DIM RED is 20 degrees of rotation.

6. Release brake pedal.

NOTE: When the brake control is leveled properly there will be very little current flowing through the brake magnets in a static state with the foot pedal depressed. The brake magnets will hum when there is current flowing through them. Anytime the Bi- Colored Light shows any color other than GREEN, there is current flowing through the brake magnets.

AIRSTREAM CLASSIC TRAILER OWNERS MANUAL

Adjusting the Power to the Trailer Brakes

Once the control has been installed and properly leveled, it is necessary to set the power needed to stop the trailer during a braking event.

1. Connect trailer to tow vehicle.
2. Set Power Knob to the 12 o'clock position.
3. Drive tow vehicle and trailer on a dry level paved surface at 25 MPH and apply the manual slide knob.
 - If trailer brakes lock up:
 - Turn power down using power knob. (Rotate power knob toward the 8 o'clock position, counter-clockwise.)
 - If braking was not sufficient:
 - Turn power up using power knob. (Rotate power knob toward the 5 o'clock position, clockwise.)
4. Repeat Step (4) until power has been set to a point just below wheel lock up or at a sufficient force as to achieve maximum braking power.
5. Using the brake pedal, make a few low speed stops to check the Power and Level adjustments. The automatic response (brake pedal) is initiated and terminated via the stoplight switch. When the brake pedal is released, trailer braking will cease.

Fine Tuning

Now that the Power has been set, it is time to fine tune the level setting for the majority of the stopping that you will be doing.

1. Make several slow (25 MPH) stops as if coming up to a stop sign and take notice of how the trailer brakes respond:

Brakes Grab Too Much

- You have an Aggressive Setting: To correct this condition rotate level knob clockwise, toward you, see below.

Trailer Tending to Push Tow Vehicle

- You have a Delayed Setting: To correct this condition rotate level knob counter-clockwise, away from you, see below.

Repeat until desired trailer braking is achieved.

NOTE:

1. Always warm the trailer brakes before setting the power. Warm trailer brakes tend to be more responsive than cold brakes. To warm trailer brakes, drive a short distance (1/4 mile) at 45 MPH with manual slide engaged approximately halfway.
2. The power should never be at a level high enough to cause trailer brakes to lock up. Skidding trailer wheels may cause loss of directional stability of trailer and tow vehicle
3. The power may need to be adjusted for different load weights and road conditions.
4. Not all trailer brakes will lock up due to various conditions.
5. When the level and power are set correctly, you should feel unified braking between the trailer and tow vehicle.
6. Braking performance may be slightly sluggish in sub-freezing temperatures. Allow adequate time for the brake control to warm prior to use in sub-freezing temperatures.

AIRSTREAM CLASSIC TRAILER OWNERS MANUAL

- When in doubt of the proper setting procedures review the above steps starting at LEVELING THE SENSOR THROUGH FINE TUNING or consult a qualified service technician.

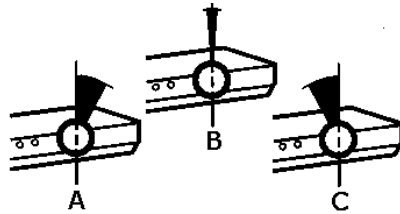

- A. Delayed
- B. Normal
- C. Aggresssive

GENERAL MAINTENANCE

BRAKE ADJUSTMENT

Brakes should be adjusted (1) after the first 200 miles of operation when the brake shoes and drums have "seated", (2) at 3000-mile intervals, (3) or as use and performance requires. The brakes should be adjusted in the following manner:

- Jack up trailer and secure on adequate capacity jack stands. Follow trailer manufacturers recommendations for lifting and supporting the unit. Check that the wheel and drum rotates freely.
- Remove the adjusting hole cover from the adjusting slot on the bottom of the brake backing plate.
- With a screwdriver or standard adjusting tool rotate the star wheel of the adjuster assembly to expand the brake shoes. (NOTE: With drop spindle axles a modified adjusting tool with an 80 degrees angle should be used. Sears Craftsman # 4736 or K-D #295 is recommended.) Adjust the brake shoes out until the pressure of the linings against the drum makes the wheel very difficult to turn.

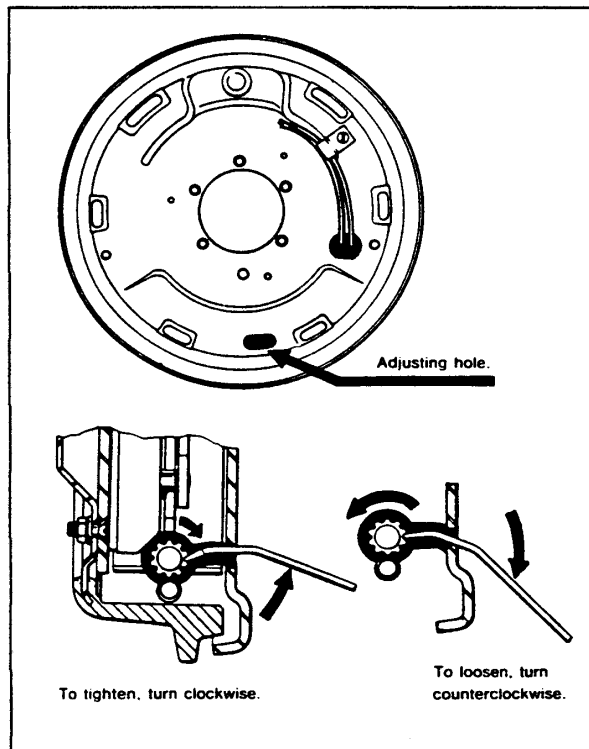

- Then rotate the star wheel in the opposite direction until the wheel turns freely with a slight lining drag.
- Replace the adjusting hole cover and lower the wheel to the ground.
- Repeat the above procedure on all brakes.

⚠ WARNING: NEVER CRAWL UNDER YOUR TRAILER UNLESS IT IS RESTING ON PROPERLY PLACED JACK STANDS.

AIRSTREAM CLASSIC TRAILER OWNERS MANUAL

BRAKE CLEANING, INSPECTION AND LUBRICATION

Your trailer brakes must be inspected and serviced at yearly intervals or more often as use and performance requires. Magnets and shoes must be changed when they become worn or scored thereby preventing adequate vehicle braking.

Cleaning and Inspection

Clean the backing plate, magnet arm, magnet, and brake shoes. Make certain that all the parts removed are replaced in the same brake and drum assembly. Inspect the magnet arm for any loose or worn parts. Check shoe return springs, hold down springs, and adjuster springs for stretch or deformation and replace if required.

CAUTION: ASBESTOS DUST HAZARD

SINCE MOST BRAKE SHOE FRICTION MATERIALS NORMALLY CONTAIN ASBESTOS, CERTAIN PRECAUTIONS NEED TO BE TAKEN WHEN SERVICING BRAKES.

- 1. AVOID CREATING OR BREATHING DUST.**
- 2. AVOID MACHINING, FILING, OR GRINDING THE BRAKE LININGS.**
- 3. DO NOT USE COMPRESSED AIR OR DRY BRUSHING FOR CLEANING. (DUST CAN BE REMOVED WITH A DAMP BRUSH.)**

Brake Lubrication

Before reassembling apply a light film of Lubricate or similar grease on the brake anchor pin, the actuating arm bushing and pin, and the areas on the backing plate that are in contact with the brake shoes and magnet lever arm. Apply a light film of oil on the actuating block mounted on the actuating arm.

CAUTION: DO NOT GET GREASE OR OIL ON THE BRAKE LININGS OR DRUMS

MAGNETS:

Your electric brakes are equipped with high quality electromagnets that are designed to provide the proper input force and friction characteristics. Your magnets should be inspected and replaced if worn unevenly or abnormally. As indicated in the diagram a straightedge should be used to check wear.

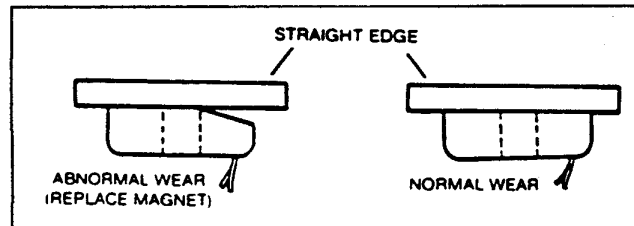

Even if wear is normal as indicated by your straightedge the magnets should be replaced if any part of the magnet coil has become visible through the friction material facing of the magnet. It is also recommended that the drum armature surface be re-faced when replacing magnets. (See Brake Drum Section) Magnets should also be replaced in pairs (both sides of an axle). Use only genuine Dexter replacement parts when replacing your magnets.

AIRSTREAM CLASSIC TRAILER OWNERS MANUAL

SHOES AND LININGS

A simple visual inspection of your brake linings will tell if they are usable. Replacement is necessary if the lining is worn thin (1/16" or less), contaminated with grease or oil, or abnormally scored or gouged. It is important to replace both shoes on each brake and both brakes of the same axle. This is necessary to retain the "balance" of your brakes.

TROUBLE SHOOTING

Most brake malfunctions that cannot be corrected by either brake adjustment or synchronization adjustments can generally be traced to electrical system failures. Mechanical causes are ordinarily obvious, i.e. bent or broken parts, worn out linings or magnets, seized lever arms or shoes, scored drums, loose parts, etc. Electrically, a voltmeter and ammeter are essential for proper troubleshooting

HOW TO MEASURE VOLTAGE

System voltage is measured at the magnets by connecting the voltmeter to the two magnet lead wires at any brake. This may be accomplished by using a pin probe inserted through the insulation of the wires dropping down from the chassis or by cutting the wires. The engine of the towing vehicle should be running when checking the voltage so that low batteries will not affect the readings.

Voltage in the system should begin at 0 volts and, as the controller bar is slowly actuated, should gradually increase to about 12 volts. This is referred to as modulation. No modulation means that when the controller begins to apply voltage to the brakes it applies an immediate high voltage, which causes the brakes to apply instantaneous maximum power.

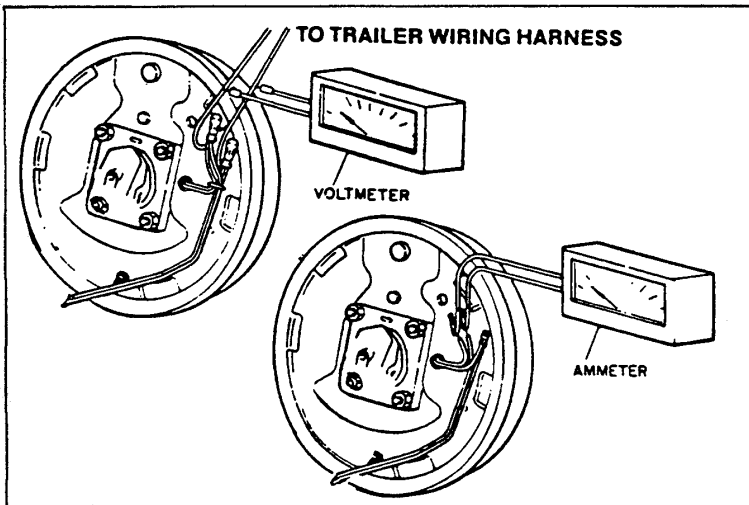

The threshold voltage of a controller is the voltage applied to the brakes when the controller first turns on. The lower the threshold voltage the smoother the brakes will operate. Too high of a threshold voltage (in excess of 2 volts as quite often found in heavy duty controllers) can cause grabby harsh brakes.

HOW TO MEASURE AMPERAGE

System amperage is the amperage being drawn by all brakes on the trailer. The engine of the towing vehicle should be running when checking amperage. One place to measure system amperage is at the BLUE wire of the controller, which is the output to the brakes. The BLUE wire must be disconnected and the ammeter put into the line. System amperage draw should be as noted in the table following. Make sure your ammeter has sufficient capacity and note polarity to prevent damaging your ammeter. If a resistor is used in the brake system it must be set at zero or by-passed completely to obtain the maximum amperage reading.

AIRSTREAM CLASSIC TRAILER OWNERS MANUAL

Individual amperage draw can be measured by inserting the ammeter in the line at the magnet you want to check. Disconnect one of the magnet lead wire connectors and attach the ammeter between the two wires. Make sure that the wires are properly reconnected and sealed after testing is completed.

By far, the most common electrical problem is low or no voltage and amperage at the brakes.

Common causes of this condition are:

1. Poor electrical connections.
2. Open circuits.
3. Insufficient wire size.
4. Broken wires.
5. Blown fuses. (Fusing of brakes is not recommended).
6. Improperly functioning controllers or resistors.

Another common electrical problem is shorted or partially shorted circuits (indicated by abnormally high system amperage). These are occasionally the most difficult to find.

Possible causes are:

1. Shorted magnet coils.
2. Defective controllers.
3. Bare wires contacting a grounded object.

Finding the system short is a matter of isolation. If the high amperage reading drops to zero by unplugging the trailer, then the short is in the trailer. If the amperage reading remains high with all the brake magnets disconnected, the short is in the trailer wiring.

All electrical troubleshooting procedures should start at the controller. Most complaints regarding brake harshness or malfunction are traceable to improperly adjusted or functioning controllers. See your controller manufacturer's data for proper adjustment and testing procedures. If the voltage and amperage is not satisfactory, proceed on to the connector and then to the individual magnets to isolate the problem source. 12 volts output at the controller should equate to 10.5 volts minimum at each magnet. Nominal system amperage at 12 volts with cold magnets, system resistor at zero and controller at maximum gain should be as detailed in the following chart:

BRAKE SIZE	AMPS/ MAGNET	TWO BRAKES	FOUR BRAKES	SIX BRAKES
10 x 2 1/4	3.0	6.0	12.0	18.0
12 x 2	3.0	6.0	12.0	18.0

NOTE: THESE AMPERAGE LEVELS WILL DROP AS THE MAGNETS HEAT UP.

AIRSTREAM CLASSIC TRAILER OWNERS MANUAL

TROUBLE SHOOTING GUIDE

SYMPTOM	CAUSES	REMEDIES
No Brakes	Open circuits Severe under adjustment Faulty controller Short circuits	Find & correct Adjust brakes Test & correct Find & correct
Weak Brakes	Grease or oil on magnets or linings Corroded connections Worn linings or magnets Scored or grooved brake drums Improper synchronization Under adjustment Glazed linings Overloaded trailer	Clean or replace Clean and correct cause of corrosion Replace Machine or replace Correct Adjust brakes Re-burnish or replace Correct
Locking Brakes	Under adjustment Improper synchronization Faulty controller Loose, bent, or broken brake components Out of round brake drums Insufficient wheel load	Adjust Correct Test & Correct Replace components Machine or replace Adjust system resistor and synchronize
Intermittent Brakes	Faulty controller Broken wires Loose connections	Test & correct Repair or replace Find & repair
Brakes pull To one side	Incorrect adjustment Grease or oil on linings or magnet Broken wires Bad connections	Adjust Clean or replace Find & repair Find & repair
Harsh Brakes	Under adjustment Improper synchronization Improper controller Faulty controller	Adjust Correct Change Test & Correct
Noisy Brakes	Under adjustment Lack of lubrication Broken brake components Incorrect brake components	Adjust brakes Lubricate Replace component Correct
Surging Brakes	Grease or oil on linings or magnet Out of round or cracked brake drums Faulty Controller	Clean or replace Machine or replace Test & correct
Dragging Brakes	Over Adjustment Out of round brake drums Incorrect brake components Loose, bent, or broken brake components Faulty breakaway switch Loose wheel hearing adjustment Bent spindle	Readjust Machine or replace Replace Replace Repair or Replace Adjust Replace

AIRSTREAM CLASSIC TRAILER OWNERS MANUAL

HUB REMOVAL

Whenever the hub equipment on your axle must be removed for inspection or maintenance the following procedure should be utilized.

1. Elevate and support the trailer unit per manufacturers' instructions.
2. Remove the wheel.
3. Remove the grease cap by carefully prying progressively around the flange of the cap. If the hub is an oil lube type then the cap can be removed by unscrewing it counter- clockwise while holding the hub stationary.
4. Remove the cotter pin from the spindle nut or, in the case of E-Z Lube versions, bend the locking tang to the free position.
5. Unscrew the spindle nut (counter-clockwise) and remove the spindle washer.
6. Remove the hub from the spindle, being careful not to allow the outer bearing cone to fall out. The seal will retain the inner bearing cone.

BRAKE DRUM INSPECTION

There are two areas of the brake drum that are subject to wear and require periodic inspection. These two areas are the drum surface where the brake shoes make contact during stopping and the armature surface where the magnet contacts.

The drum surface should be inspected for excessive wear or heavy scoring. If worn more than .020" oversized, or the drum has worn out of round by more than .015", then the drum surface should be turned. If scoring or other wear is greater than .090", the drum must be replaced. When turning the drum surface the maximum re-bore diameter is as follows:

10" Brake Drum- 10.090"

12" Brake Drum- 12.090"

The machined inner surface of the brake drum that contacts the brake magnet is called the armature surface. If the armature surface is scored or worn unevenly it should be refaced to a 120 micro-inch finish by removing not more than .030" of material. To insure proper contact between the armature face and the magnet face, the magnets should be replaced whenever the armature surface is refaced and the armature surface should be refaced whenever the magnets are replaced.

NOTE: IT IS IMPORTANT TO PROTECT THE WHEEL BEARING BORES FROM METALLIC CHIPS AND CONTAMINATION WHICH RESULT FROM DRUM TURNING OR ARMATURE RE-FACING OPERATIONS. MAKE CERTAIN THAT THE WHEEL BEARING CAVITIES ARE CLEAN AND FREE OF CONTAMINATION BEFORE REINSTALLING BEARINGS AND SEALS. THE PRESENCE OF THESE CONTAMINANTS WILL CAUSE PREMATURE WHEEL BEARING FAILURE.

AIRSTREAM CLASSIC TRAILER OWNERS MANUAL

Load/Inflation Information for Your Tires

Maintaining proper tire inflation pressure is essential for both tire safety and performance.

Proper Tire Inflation

The level of air in your tires affects your vehicle's overall performance. Not even the highest quality tire will perform well if it's not inflated properly. The correct pressure varies from vehicle to vehicle and depends in part upon driver preference. Each vehicle has a maximum inflation pressure, usually found on a metal tag riveted to the outside of the vehicle as well as on the original equipment tires.

Correct tire inflation is a key component in tire care. The recommended inflation pressures for your tires are indicated on the certification label or in your owner's manual. Since RVs can be loaded with many different configurations, the load on each tire will vary. For this reason, air pressure should be checked based on the load on each individual tire. Cold Inflation Pressure should be adjusted to handle the maximum tire load, and all tires on the axle should carry the same inflation pressure. **COLD TIRE INFLATION PRESSURE** is the tire pressure checked in the morning before you drive more than a few miles or before rising ambient temperatures or the sun's radiant heat affects it. Check your tires' air pressures at least once a month, before each trip and each morning you drive during a trip. Tire pressure should be checked cold, as tire pressure ratings have been designed with typical running heat/pressure build-up in mind. Make sure the valves and caps are free of dirt and moisture.

Underinflation

Underinflation brings a higher risk of damage due to road hazards, reduces casing durability, causes a loss in fuel economy, and uneven or irregular tire wear. Severe underinflation brings about an increased risk of tread separation, handling difficulties, and possibly tires failure, caused by overheating.

IMPORTANT: Lowering tire pressure in the search for a smoother ride is not only dangerous, it's relatively ineffective, and as the difference in the ride quality is not significant. When minimum inflation pressure requirements are not met, tire durability and optimum operating conditions are compromised. Tire inflation pressure should always meet the guidelines for vehicle weight.

- It may be necessary to inflate your tires at a truck stop or truck service center in order to achieve adequate air pressure for your coach's needs
- Only permanent air seal metal valve caps should be used.
- Be safe - if a tire has been run 20% under inflated, it must be dismounted and inspected by a trained professional. It should not be aired up without a full inspection or without using a safety cage. Use a calibrated gauge. If your tire is rated for higher inflation pressures, a special gauge will be required designed for larger tires.
- Don't bleed air from warm tires to reduce pressure buildup
- Don't inflate tires to cold PSI rating beyond rim specifications

HOW OVERLOADING AFFECTS YOUR TIRES

Tire pressure is what enables your RV tire to support loads. Overloading your tires can have serious consequences for passengers and your RV. Too much weight can cause stress on your RV's suspension system, brake failure, shock absorber damage, handling and steering problems, irregular tire wear and possible tire failure. Excessive loads or underinflation can lead to an excessive amount of heat and tire failure. If you discover that your tires cannot handle the load, lighten the weight of the load on your tires.

Tire pressure should never be reduced below the vehicle manufacturer's recommended levels to support load conditions in order to improve the ride quality of a vehicle. The difference in ride quality is not significant. When inflation pressure requirements are not met, tire durability and optimum operation can be affected.

AIRSTREAM CLASSIC TRAILER OWNERS MANUAL

INTERIOR

The interior of all Airstream trailers has been designed for comfort, convenience, durability and appearance. How you use it and how you take care of it naturally depends on you. However, if you learn to operate the interior components and take care of them and the trailer properly, this knowledge will add to your pleasure as well as the long life of your trailer.

All materials should be professionally dry cleaned to remove any overall soiled condition. However, these materials may be spot cleaned using the cleaning code instructions as listed. Sample swatches are furnished to our dealers. The dealer will be able to give you the name of the fabrics used in your particular trailer. Each swatch will show the cleaning code in parenthesis.

Upholstery

The following are the cleaning code instructions for the various fabrics used in the Airstream trailers:

Code WS

Fabric Care: Spot clean this fabric either with a mild solvent or water based cleaning agent. When using a solvent or dry cleaning product follow instructions carefully and clean only in a well-ventilated room. Avoid any product, which contains highly toxic carbon tetrachloride. You may also use an upholstery shampoo product or the foam from a mild detergent. With either method pretest a small area before proceeding. Use professional furniture cleaner when an overall soiled condition is reached.

Code S

Fabric Care: Spot clean, using a mild water free solvent or dry cleaning product. Carefully follow instructions on such product. Clean only in a well-ventilated room. Avoid any product containing carbon tetrachloride, which is highly toxic. Pretest small area before proceeding. Use professional furniture cleaner when an overall soiled condition is reached.

Code W

Fabric Care: Spot clean, using the foam only from water based cleaning agent such as mild detergent or non-solvent upholstery shampoo product. Apply foam with a soft brush in a circular motion. Vacuum when dry. Pretest small area before proceeding. Use professional furniture cleaner when an overall soiled condition is reached.

The manufacturer of the fabrics designed the above code.

Leather

Clean leather fabrics with standard products used for that purpose. Follow instructions on the cleaning products container.

CAUTION: Never remove cushion cover for separate dry cleaning or washing. Any tumble cleaning method can destroy the backing, shrink or otherwise damage upholstery fabric.



WARNING: Keep your furniture and family safe from fires caused by careless smoking. Do not smoke when drowsy. Remove immediately any flowing ash or a lighted cigarette, which falls on furniture. Smoldering smoking material can cause upholstered furniture fires.

AIRSTREAM CLASSIC TRAILER OWNERS MANUAL

Draperies

CAUTION: All drapery materials and mattress covers must be professionally dry-cleaned.

Unsnapping from the wall, removing a screw or pop rivet from the end of the curtain track, and sliding them out remove draperies. The pop rivets are removed by drilling through the head with a 1/8" drill bit.

To prevent damage to the draperies while traveling, the VENETIAN TYPE BLINDS should be lowered, secured at the bottom and the slats turned vertically.

Carpet

The carpet can be cleaned with any good commercial carpet cleaner, or with a detergent and water. BE CAREFUL NOT TO SOAK THE CARPET WITH WATER.

Vinyl Floor

The vinyl floor in your unit can be cleaned with liquid floor cleaning solutions recommended for vinyl floors and warm water.

Counter Area

The counter areas around the sink are of a high-pressure laminate or Corian and can be cleaned with soap and water, or you can use a common solvent on tough spots. Be sure no abrasive cleaner is used, as there is the possibility it could scratch the surface. A protective pad should always be placed under hot utensils.

Sanding minor damaged areas can repair Corian counters. The color of the material is constant and not just a surface coat.

Vinyl Covering

Damp wiping with mild detergent does routine cleaning. Using any of the automotive cleaners designed for vinyl car seats and dashes can perform more thorough cleaning.

Sinks

The stainless steel galley sink can be cleaned with a commercial stainless steel cleaner available at most stores.

The lavatory sink is a very dense material called KARRAN. In the unlikely event of it ever being stained powdered cleansers such as Ajax/Comet may be used or even Scotch-Brite pads. The color is constant through the thickness of the material,

Shower Stall

To clean your fiberglass shower stall unit use warm water and one of the stronger liquid detergents. Do not use abrasive cleaners, they may scratch and dull the surface of your fiberglass unit. Stubborn stains can be removed with solvents such as turpentine, paint thinner or acetone. Restore dulled areas by rubbing with an automotive type liquid cleaner then put the soft slow back into your fiberglass unit with a light application of liquid wax.

Lounges

To convert the front lounge to a bed first set the armrest cushions out of the way, lift up on the front of the seat and pull it out. This will unhinge the sofa so it can be pushed flat into a bed.

AIRSTREAM CLASSIC TRAILER OWNERS MANUAL

Dinette

The dinette is made into a bed by rising up on the front of the table and folding the table leg up against the bottom of the leaf. As the table is raised it will unhook from the upper wall brackets. Once it is unhooked it can be pulled out and the wall hinge will let it be lowered on the supports of the dinette seats. The backrests of the seats are placed over the table to complete the conversion.

Table

To open the folding table, lift into a horizontal position and pull the table leg down toward the vertical position until it snaps into place. The leg is hinged at the front edge of the table and is held against the bottom of the table with Velcro. To extend into the double leaf position, lift the table slightly so the leg clears the carpet, and slide the leg and center support out toward the center of the trailer. The leaf then unfolds and rests against the leg support.

Airstream recommends that during travel the table be left in the upright position.

Monitor Panel

The monitor panel allows you to check the amount of fluid in your fresh water tank, black tank, and the gray tank.

The LP gas and battery status are also shown.

Battery Condition Tester

The battery condition tester, used when not plugged into 110-volt power, will indicate the trailer batteries condition. When they show weak or bad condition you should take every reasonable step to conserve power by using as few lights as possible and switching off appliances. The battery should be charged as soon as practical with the tow vehicle charging system, or by connecting to shoreline 110-volt power.

Water Pump Switch

The water pump switch operates the pump. Once the switch is turned on the pump will run until the water pressure reaches about 65 psi. At this point an internal pressure switch will shut it off. When a faucet is opened the water pressure will drop and the pump will start to run again. The water pump switch should be turned off when the trailer is left unattended. Water pressure at some campgrounds may be low. The water pump can be turned on to assist the city water hookup pressure. Be sure there is some water in the fresh water tank. The pump will only use the water that is needed out of the tank to bring the pressure up to the usual standard.

Bathroom Exhaust Fan

The bathroom exhaust fan is in the bathroom ceiling and is opened by pushing up on the handle running across the fan opening.

Telephone Shower Head

The telephone showerhead is designed to give maximum flexibility in usage, and provides for water saving techniques when using your trailer on self-containment. It can be held in the hand and moved about the body. Normally the best water conservation procedure is to wet the entire body and then turn the water off. Apply soap, lather thoroughly, and then rinse the soap off. The telephone showerhead is also used to fill the tub for taking a bath. When you have finished using the shower be sure to shut the water off at the faucet.

AIRSTREAM CLASSIC TRAILER OWNERS MANUAL

Bath Area Remote Switches

Two remote switches for appliances are located on the bathroom wall. One is for the water pump, and duplicates the pump switch on the central control panel. Either pump switch may be used to turn the pump on or off at any time.

The second pair of switches, with a red indicator, is for lighting the water heater.

Incandescent Light Fixtures

The light fixture has a switch located on the end of the fixture. Gently squeezing in the middle and pulling down may remove the LENS. During cold weather it is a good idea to leave the light on a few minutes prior to removing the lens.

Fluorescent Ceiling Lights & Light Bulbs

A wall switch just inside the door control lights in the forward section and a second wall switch in the bedroom will control the bedroom ceiling light. Each light also has its own individual switch. The wall must be turned on for the light switch to work.

Rotating one-quarter turn and bringing the bulb straight out of the fixture will remove fluorescent light bulbs. This would be straight out on bed lights and straight down on ceiling lights.

Fresh Air Vents

A control handle operates the fresh air vents. Turning clockwise will raise the vent and at the maximum extension, vents with fans will automatically turn on. For maximum air without fan, open until fan starts and back up just enough to turn fan off. Turning counterclockwise will close the vent. Screens should be removed for periodic cleaning.

Information on the optional high volume roof vent may be found in the appliance section of this book,

Storage

The kitchen cabinet should have the heaviest items on the bottom and lighter items overhead. After loading you should have the skillets and can goods on the floor or bottom shelf, and the cereals and crackers in the overhead rooflocker. Use the unbreakable type plates and saucers, and consider storing your dishtowels around them. Better yet, use paper plates. Who wants to wash dishes when on a trip or vacation?

A good place to store heavy items is in the front drawer assembly. It is rated for a 100 lb. capacity, plus adding weight to the front of the trailer may even improve towing slightly.

Clothes hung in wardrobes should be kept on hangers that snap over the clothes rods to keep them from "jumping" off on rough roads. Evening dresses should be kept in the plastic bags like dry cleaning businesses use. No matter how hard you try, if you travel a long dusty section of road the dust will work its way into the trailer and soil clothes. Try to avoid large bulky coats. Layers of lighter clothing will usually keep you warmer, are more versatile and easier to store.

Some additional storage is available under the shelf in the bottom of the wardrobe, but you must be sure it is loaded so the drain lines and heat ducts can't be damaged.



WARNING: Keep flammable material away from the furnace.

Remember, heavy items should be stored low and toward the front, lighter items in the rear and overhead cabinets.

AIRSTREAM CLASSIC TRAILER OWNERS MANUAL

SMOKE ALARM - FIREX MODEL B

IMPORTANT INFORMATION SMOKE ALARM SAFETY CHECKLIST

1. Test your smoke alarm every week. To test the electronics, firmly depress the button. To test that smoke reaches the sensor, blow smoke in a careful fire-safe manner into your smoke alarm.
2. Your smoke alarm will not work without power. Never shut off its power or remove the battery to quiet the alarm.

FOR BATTERY-POWERED UNITS: When your smoke alarm "beeps" about once a minute, the battery is weak. Immediately install a new battery correctly. Be sure to use only batteries specified in Owner's Manual or on unit. Test unit after installing a new battery.

3. Clean and vacuum the openings on your smoke alarm once a month.
4. Do not open the smoke alarm or try to repair it. For replacement information see the WARRANTY in the Owner's Manual.
5. Verify you have the proper number of smoke alarms in your home and the correct location for each one. A smoke alarm will not respond well in an incorrect location.
6. If your smoke alarm has one or more of these special features, please note:
 - FALSE ALARM CONTROL (Model C): Pushing test/hush button reduces sensitivity for up to 15 minutes, minimizing nuisance alarms,
 - FLASHING LIGHT (Model E): Pushing test button turns flashing safety light on. Very thick smoke may obscure light.
7. Smoke alarms have technical limitations and may not respond in all situations. **FIRE PREVENTION** is your best safeguard.
8. For a replacement Owner's Manual or Safety Checklist, please indicate your unit model, include a self-addressed stamped envelope and send to:

Maple Chase Company

2820 Thatcher Road

Downers Grove, Illinois 60515-4040

WEEKLY TESTING OF YOUR SMOKE ALARM

1. FOR A COMPLETE WEEKLY TEST OF THE ELECTRONICS AND THE SENSOR OPERATION, FIRMLY DEPRESS THE TEST BUTTON ON THE COVER OF THE SMOKE ALARM FOR A FEW SECONDS. The smoke LED (light emitting diode), which is the indicator light under the clear Push-to-Test button, will blink once per second while the button is being pushed and the alarm is sounding. The smoke alarm will stop sounding when you release the button.
2. If your smoke alarm has the False Alarm Control or Safety Light feature see "SPECIAL SMOKE ALARM FEATURES" for further testing information.
3. **IMPORTANT:** Always test your smoke alarm upon returning from vacation, or any other time when no one has been in your household or residence for several days.

AIRSTREAM CLASSIC TRAILER OWNERS MANUAL

4. If a smoke alarm is installed in a mobile home, test the smoke alarm after you remove the vehicle from storage and before each trip.



WARNING: If your smoke alarm does not respond as described in any of the above tests, check that a good battery is properly installed. If a good battery is properly installed, promptly remove the unit, repack it and return it for repair or replacement.

TAKING CARE OF YOUR SMOKE ALARM

Your smoke alarm has been designed and manufactured to be as maintenance-free as possible. Here are a few simple steps you must perform, in addition to the weekly tests described in the section "WEEKLY TESTING OF YOUR SMOKE ALARM," to keep your unit in good working order.

- The smoke alarm should be vacuumed monthly or more often if there is dust, dirt or kitchen grease that can accumulate. Use a soft brush or wand attachment and vacuum all slots in the cover and side. **FOR YOUR SAFETY**, you must properly clean and maintain your smoke alarm, since a dirty or malfunctioning unit may fail to alarm or cause unwanted nuisance alarms.
- If the unit is damaged or fails to operate properly, and you have checked that a good battery is installed correctly, follow the directions in the section "WHERE TO SEND YOUR SMOKE ALARM IF IT NEEDS SERVICE" for return. **FOR YOUR SAFETY, DO NOT OPEN THE SMOKE ALARM AND TRY TO REPAIR IT YOURSELF.** While smoke alarms are economical devices, they contain precision electronic components that are precisely calibrated. The manufacturer must do repairs.

REPLACING THE BATTERY

The smoke alarm will "beep" once a minute for at least 30 days when the battery is weak. The battery must **immediately** be replaced with a fresh one.

The battery should also be changed if it does not sound an alarm when tested. **TO REPLACE THE BATTERY:**

1. Check if the tamper resist locking pin is installed in the smoke alarm (see "USING THE TAMPER RESIST LOCKING MECHANISM" section). If so, pull the pin completely out of the smoke alarm using long-nose pliers.
2. Remove the smoke alarm from the mounting bracket by twisting counterclockwise
3. Replace old battery with a fresh one. If your smoke alarm has a safety light, the miniature lamp operates on two AA batteries. (See recommended batteries below.)
4. Check that battery connections are secure and the battery is secured in its compartment
5. Test smoke alarm for proper operation (see "WEEKLY TESTING OF YOUR SMOKE ALARM" section). The smoke alarm operates on a 9-volt battery. The normal battery operating life will be one (1) year. The life of some batteries may be less.
6. Firex smoke alarms sold with Ultralife long-life lithium batteries require replacement approximately every ten (10) years or when the low battery signal sounds.

CAUTION: You should only use the batteries specified here or on the label of the unit.

AIRSTREAM CLASSIC TRAILER OWNERS MANUAL

For Models A, B, C, E and PB use: Eveready 216, 522 or 1222; Mallory MN1604; Duracell MN1604; or Ultralife U9VL-J.

For Model E also use AA Heavy Duty for light power. The miniature lamp operates on two (2) AA batteries. For replacement, use heavy-duty or alkaline AA batteries: Eveready 1215, E91, or Duracell M15HD, MN1500.

CAUTION: Do not use any type of rechargeable batteries.

USING THE TAMPER RESIST LOCKING MECHANISM

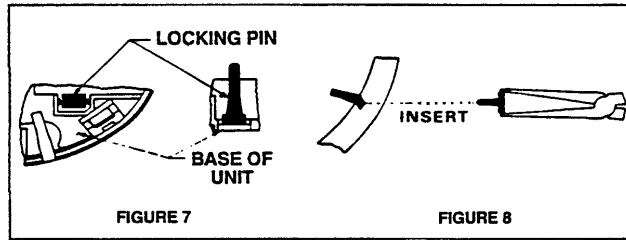

To make the smoke alarm somewhat tamper resistant, a "locking pin" has been provided in the base of the unit. It will help deter a child or other individual from removing the smoke alarm from the bracket. See Figure 7. The following directions can install this.

1. Remove the break-away locking pin from the unit by rocking pin back and forth.
2. Put the smoke alarm back on the mounting bracket. (See section "HOW TO INSTALL YOUR SMOKE ALARM.")
3. Using long-nose pliers grab the head of the locking pin and insert into hole located on the side of the smoke alarm. See Figure 8.
4. The Tamper Resist feature is now installed and complete.

To Remove:

5. Using long-nose pliers grasp the head of the locking pin and pull the pin completely out of the smoke alarm.
6. The smoke alarm can now be removed from the mounting bracket with a counterclockwise twist.

SPECIAL SMOKE ALARM FEATURES

If your smoke alarm has one or more of these special features, read the following:

- **BLINKING LED LIGHT** (Models B, C, E and PB): The indicator light under the Push-to Test button blinks about once per minute to indicate the smoke alarm is receiving power.



WARNING: Very thick smoke may obscure the light.

AIRSTREAM CLASSIC TRAILER OWNERS MANUAL

LP GAS DETECTOR

In the kitchen area of your unit, approximately six inches above the floor, is the LP gas detector. LP gas is a mixture of gases produced and sold commercially as a fuel for heating and cooking appliances. LP gas is highly flammable and, as a result, can be explosive if ignited under certain circumstances. LP gas is heavier than air and, if confined in a closed space, will accumulate close to the floor. When the LP gas concentration in your unit exceeds 2000 PPM the detector will provide a visual and audible alarm by sounding a buzzer and flashing the red LED two times per second.



WARNING Activation of this detector indicates the presence of LP gas, which can cause an explosion and/or fire. This normally indicates a leak in the LP gas installation or a LP gas appliance. Extinguish all open flames, open your windows and door and evacuate the unit immediately. Do not activate any electrical switch. Turn off the LP at your gas bottle(s). **DO NOT RE-ENTER YOUR UNIT UNTIL A QUALIFIED REPAIR TECHNICIAN HAS CORRECTED THE PROBLEM.**

OPERATION

Your LP gas detector is wired directly to your vehicle battery and incorporates a 1-amp in-line fuse. When the device is operating normally the green LED will be lit.



WARNING It is not recommended that the detector be disconnected from the battery during periods of storage. There is a small heater on the sensor of the device, which "burns" away impurities in the air during periods of normal use. During periods when power is interrupted, impurities can build up on the sensor. When power is returned to the detector the detector alarm may activate until the impurities are "burned" off. This could take a number of hours, during which time the alarm will be constantly "on".

DETECTOR TEST

Press the test button for 5 to 6 seconds until the alarm sounds then release the test button. The red LED should flash and the alarm sound for approximately 4 minutes. This test should be performed at least once a week during normal vehicle operation, and after periods of storage, and before each trip.

LOW VOLTAGE

Below 10 VDC the detector will continue to operate but will blink alternately green and orange. Below 8 VDC the unit will behave erratically and will eventually shut off. To ensure proper operation, do not operate the unit below 10 VDC.

COMPONENT FAILURE

The failure of any circuit component will cause the detector to display a continuous orange LED fault light and a short beep indicating failure. If this occurs, immediately contact your dealer or Airstream Customer Service for the name of the nearest detector service center.

Please read the operating instructions for your detector, which have been supplied with the paper work of your unit.



WARNING: Have a professional check your system if you have any doubts.

AIRSTREAM CLASSIC TRAILER OWNERS MANUAL

FIRE EXTINGUISHER

The fire extinguisher just inside your forward door should have the charge checked on a regular basis. Make sure your family, especially the cook, knows how to release the extinguisher storage bracket, and how to properly operate the extinguisher. If you find the directions on the extinguisher unclear, check with your local fire department for professional advice on its operation and use. We're sure they will be happy to assist you and your family.

SAFETY:

Many things can be construed as safety related, but the most important is your common sense. If you are careless with matches, cigarettes, flammable material or any other hazardous material, we are sure you realize your potential for accidents is greatly increased.

EXTERIOR WINDOWS

The windows in your trailer are safety glass. To open: release the two lever locks at the bottom, lift up on the two side operator handles until the window is in the desired position, and place the operators into one of three positioning slots on the side of the frames. To lock the windows, reverse this procedure.

Note: Some windows are designed as emergency escape exits. The rubber spline holding the screen in place is looped so it can be pulled out in one swift motion.

You and all your family should practice escape procedures so they can be rapidly accomplished even in total darkness.



WARNING: Never park your trailer so the escape windows cannot be easily used for emergency exits.

These windows are cleaned in the same manner that ordinary windows are. Clean the seals with a damp cloth or mild detergent every three to six months, taking care not to use a strong solvent, as it will damage the seals. A coat of natural silicone lubricant applied after the seal has dried will keep it flexible. Spread the lubricant evenly with a brush or finger, working it into the surface. This is a good practice for all rubber seals in your Airstream. For replacement of a damaged window contact an Airstream Service Center or the factory.

SCREENS

Your plastic screens are easy to maintain. Just clean them occasionally with a damp cloth.

Note: They will melt at the point of contact if touched by a cigarette.

AIRSTREAM CLASSIC TRAILER OWNERS MANUAL

NOTES

AIRSTREAM CLASSIC TRAILER OWNERS MANUAL

PLUMBING SYSTEM

LIQUID PETROLEUM GAS (LPG)

FILL VALVE

Your trailer is equipped with LP tank fill valves called "RV Type I Acme" connection. The large, green, nylon swivel nut is a right hand thread and is designed for **hand operation only**. The valve features an internal spring-loaded module that will not allow gas to flow from the cylinder until a positive seal has been made at the connection. The valve outlet has 1-5/16" Acme threads on the outlet exterior and female POL, left-handed threads on its interior. This feature allows for connection of the new wrenchless, right-handed, Acme RV connection and still accommodates the standard left-handed POL fittings used for filling propane cylinders.

The mating, green swivel nut and brass nipple also incorporates new features: the green nylon nut swivels on a black bushing that is heat sensitive. Between 240 degrees F and 300 degrees F the bushing will yield (melt) allowing the spring-loaded module in the valve to push the brass nipple back (approximately 1/4") closing the module and stopping the flow of gas from the cylinder. Inside the brass nipple is a flow-limiting device designed to sense excessive gas flow. If an excessive flow is sensed, the flow-limiting device shuts the flow down to a maximum of 10 SCFH (Standard Cubic Feet per Hour) or less. This is also referred to as the by-pass flow.

By-pass flow is extremely important in the proper operation of this connection. The flow-limiting device may activate if the cylinder valve is opened quickly. When all appliances are off, the by-pass flow allows the pressure downstream from the flow-limiting device to equalize. When pressure is equalized, the flow-limiting device will supply normal flow to the system. Equalization occurs in approximately 5 seconds and in most cases goes completely unnoticed. If, however, an appliance is left on or there is a leak or open flow in the system, the by-pass pressure will not be able to equalize and allow the flow-limiting device to re-open. Symptoms of this condition would be appliances that light but have lower than normal flame or starve out from lack of gas, a substantial reduction in the flame when another appliance is operating, or pilots that are difficult to light. If this should happen, the following steps should eliminate the condition:

1. Close LP cylinder valve.
2. Extinguish all flames and smoking materials
3. Be sure all gas appliances, including their pilot lights, are off.
4. Open LP cylinder valve slowly. DO NOT SNAP OPEN.
5. Wait at least 15 seconds before lighting appliances.
6. If operational difficulties continue, there may be a leak in the system. Immediately close the LP cylinder valve and have the system inspected by a qualified RV service technician.

Again, make sure all appliances are off before opening propane cylinder valves.

Exception: when reconnecting a full cylinder to an auto changeover regulator it is not necessary to shut off the appliances or close the valve of the cylinder already in service.



WARNING: LEAKING LP GAS MAY IGNITE CAUSING A FIRE OR EXPLOSION WHICH COULD RESULT IN SERIOUS BODILY INJURY, PROPERTY DAMAGE, OR DEATH.

How long a full tank of gas will last is dependent on usage. In cold weather, when you are using the furnace, large amounts of hot water, and are doing extensive cooking, you will naturally use more than you will in warm weather when you may do limited cooking. On the average, with normal cooking and other appliance use you can probably count on two to three weeks of service from each tank.

AIRSTREAM CLASSIC TRAILER OWNERS MANUAL

AUTOMATIC GAS REGULATOR

All models are equipped with an automatic gas regulator. Both tanks are connected to this regulator. Open both tank valves completely, then close about 1/4 turn. This will allow you to easily check to see if valves are open or closed.

When the gas is turned on it is drawn from only one tank at a time. When the tank being used is depleted the regulator automatically switches to the full tank. An indicator in the regulator knob points toward the tank which was being used to give you a visual reminder when one tank is empty.

Note: The tank in use is not completely empty until the red warning flag is fully visible in the indicator window. The empty tank can be removed for refilling without disturbing the tank being used.



WARNING: LP gas regulators must always be installed with the diaphragm vent facing downward. Regulators that are not in compartments have been equipped with a protective cover. Make sure that regulator vent faces downward and that cover is kept in place to minimize vent blockage, which could result in excessive gas pressure causing fire or explosion.

CAUTION: The LPG bottles are securely mounted on the front "A" frame of your trailer. If these bottles must be removed for service or replacement it is important that they be reinstalled correctly in order to prevent any possibility of their falling off or becoming dislodged during travel.

LPG BOTTLES

The following step-by-step procedure gives you the proper method of removing and installing these bottles:

1. Turn the knob on your automatic regulator so the arrow points to the tank opposite the one to be removed. Shut off the gas valve on the bottle to be removed.
2. Disconnect the rubber gas line at the bottle to be removed. (This fitting has a left hand thread and turns in the opposite direction to most threaded fittings.)
3. Turn the large clamping "T" handle counterclockwise until the hold down bracket is loose enough to remove the bottle. If your trailer is equipped with a gas bottle cover the "T" handle must be removed, and then remove the cover before removing the bottle.

DO NOT REMOVE THE CENTER HOLD DOWN ROD.

AIRSTREAM CLASSIC TRAILER OWNERS MANUAL

To Install

1. Place the bottle in position on the "A" frame and bottle cross member so that it rests on the upper collar of both bottles with the collar rims engaged in the grooves on the underside of the bracket. If your trailer is equipped with a gas bottle cover it should be positioned over the bottles next. Make sure the hold down rod projects up through the hole in the shroud center bracket.
2. Replace the "T" handle and tighten down until the bottles are held firmly in place.
3. Turn on gas shut off valves and test all fittings with a soap suds or detergent solution and watch for bubbles.

If you have allowed both tanks to run out, air may have gotten into the lines. In this event, the air must be forced out through the lines by gas pressure before you will be able to light the pilots. Hold a match to the pilot of the appliance closest to the tanks until it lights and stays lit. Then move to the next closest, etc.

Twice a year, or after a long storage period, we suggest you take your unit in for a checkup and cleaning of the gas operated appliances.

BASIC RULES FOR SAFETY



WARNING: Your LP tanks must be filled as directed by the tank manufacturer. Instructions are located on a decal near the fill valve. The decal must not be defaced.



WARNING: Your LP tank must be, and can only be, placed in the proper position when remounting on the front of the trailer. In any other position the base of the tank will not fit into the recess.



WARNING: Use only the gas bottles furnished with your trailer. If replacement is required it must be a bottle of the same size and design.



WARNING: The vent at the bottom of the regulator must be kept free of any obstructions and must be pointed downward. A good habit is to check the vent each time a bottle is removed for filling. It is especially important to check the vent if the trailer has not been used regularly.



WARNING: Do not store LP containers within a vehicle. LP containers are equipped with safety devices that vent gas should the pressure become excessive.



WARNING: Do not use cooking appliances for comfort heating. Cooking appliances need fresh air for safe operation. Before operation open an overhead vent or turn on an exhaust fan and open a window.

A warning label has been located in the cooking area to remind you to provide an adequate supply of fresh air for combustion. Unlike homes, the amount of oxygen supply is limited due to the size of the recreational vehicle; and, proper ventilation when using the cooking appliances will avoid dangers of asphyxiation. It is especially important that cooking appliances not be used for comfort heating as the danger of asphyxiation is greater when the appliance is used for long periods of time.

Continued next page

AIRSTREAM CLASSIC TRAILER OWNERS MANUAL

BASIC RULES FOR SAFETY



WARNING: Portable fuel burning equipment, including wood and charcoal grills and stoves, shall not be used inside the recreational vehicle. The use of this equipment inside the recreational vehicle may cause fires or asphyxiation.



WARNING: A warning label has been located near the LP gas container. This label reads: **DO NOT FILL CONTAINER (S) TO MORE THAN 80 PERCENT OF CAPACITY.**

Overfilling the LP gas container can result in uncontrolled gas flow, which can cause fire or explosion. A properly filled container will contain approximately 80 percent of its volume as liquid LP gas.



WARNING: Do not bring or store LP gas containers, gasoline or other flammable liquids inside the vehicle because a fire or explosion may result.



WARNING: IF YOU SMELL GAS:

1. Extinguish any open flames, pilot lights and all smoking materials.
2. Do not touch electrical switches.
3. Shut off the gas supply at the tank valve(s) or gas supply connection.
4. Open doors and other ventilating openings.
5. Leave the area until odor clears.
6. Have the gas system checked and leakage source corrected before using again.

AIRSTREAM CLASSIC TRAILER OWNERS MANUAL

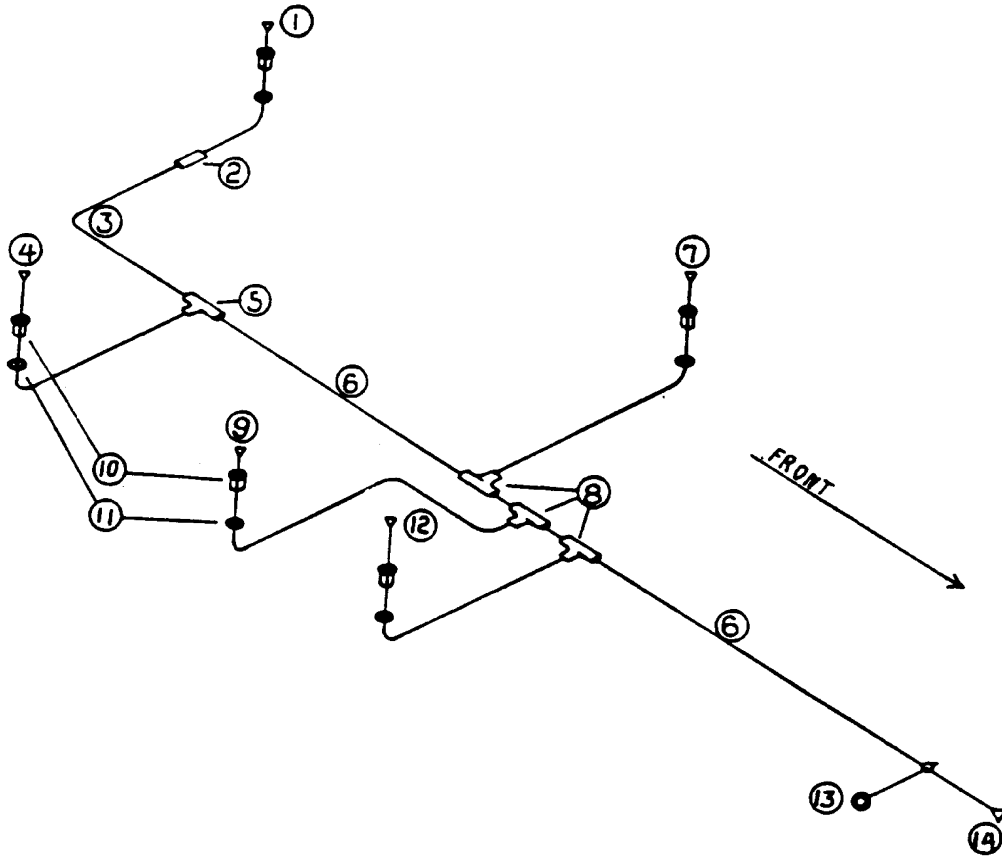

TYPICAL GAS LINE SYSTEM

1. Connection, Water Heater
2. 3/8" Flare Coupler
3. 3/8" OD Copper Tubing
4. Connect, Second Furnace
5. 5/8 x 3/8 x 3/8 Brass Tee
6. 5/8 OD copper Tubing
7. Connection, Refrigerator
8. 5/8 x 5/8 x 3/8 Brass Tee
9. Connection, Range
10. Grommet, Floor Level
11. Grommet, Underbelly
12. Connection, Front Furnace
13. Ground Lug
14. Connection, LP Regulator

AIRSTREAM CLASSIC TRAILER OWNERS MANUAL

WATER SYSTEM-SELF CONTAINED

Fill the water tank by opening the exterior access door and remove screw cap. A garden hose can now be inserted. It's a good idea to let the water run through the hose for a short time to flush it out. Experienced RVers usually fill their tanks with "home" water to avoid strange water that may be distasteful to them.

The amount of water in the tank may be checked on the Monitor Panel, or you may fill the tank until water overflows out of the fill.

Turn water heater by-pass valves, located in lavatory cabinet next to water heater, to normal flow position. Shut off valve B - open valves A and C. In some models the valves may be in a horizontal pattern rather than the vertical shown in the illustration. Valve operating sequence will be the same. Access to the valves in most units is through the lavatory cabinet door; on others it will be necessary to remove a drawer.

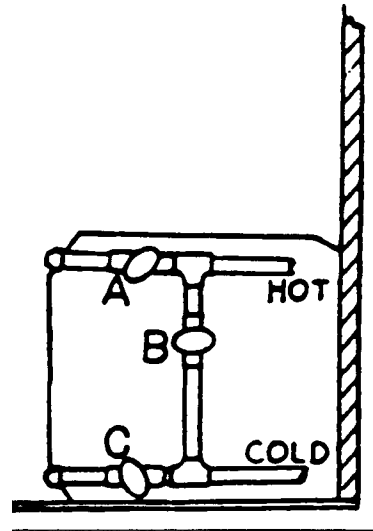

Open the hot side of the galley or lavatory faucet and turn on the water pump switch located on the monitor panel. For some time the open faucet will only sputter. This is because the water heater is being filled and air is being pushed out through the lines. Once the water heater is full a steady stream of water will come from the faucet. Now open a cold faucet. It will sputter for a short time, but will soon expel a steady stream. All other faucets can now be opened until all air is expelled.

Once the system is filled with water and the faucets closed, the water pump will shut off. When a faucet is opened the pump will come back on automatically. If the faucet is just barely open it is normal for the pump to cycle on and off rapidly.

Water pressure at some campgrounds may be low on city water. The water pump can be turned on to assist the city water hookup pressure. Be sure there is some water in the fresh water tank. The pump will only use the water that is needed out of the tank to bring the pressure up to the usual standard.

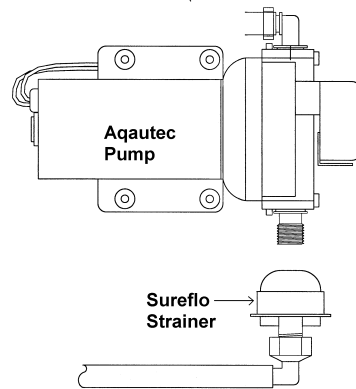

WATER PUMP AND STRAINER

The water pump and strainer are located in the curbside wardrobe on all models.

To clean strainer screen, first remove inlet connection from the pump side of strainer. This will allow the intake side of the strainer to be rotated about 1/8 turn counter clockwise and be removed. The screen part of the strainer will now be accessible for cleaning.

When reassembling only rotate the inlet side of the strainer until the stops are felt. The "O" ring performs sealing and too much pressure will only break the strainer.

AIRSTREAM CLASSIC TRAILER OWNERS MANUAL

SANITIZING

Potable water systems require periodic maintenance to deliver a consistent flow of fresh water. Depending on use and the environment the system is subject to, sanitizing is recommended prior to storing and before using the water system after a period of storage. Systems with new components, or ones that have been subjected to contamination, should also be disinfected as follows:

1. Use one of the following methods to determine the amount of common household bleach needed to sanitize the tank.

A) Multiply "gallons of tank capacity" by 0.13; the result is the ounces of bleach needed to sanitize the tank.

B) Multiply "Liters of tank capacity" by 1.0; the result is the milliliters of bleach needed to sanitize the tank.

2. Mix into solution the proper amount of bleach within a container of water.

3. Pour the solution (water/bleach) into the tank and fill the tank with potable water.

4. Open all faucets (Hot & Cold) allowing the water to run until the distinct odor of chlorine is detected.

5. The standard solution must have four (4) hours of contact time to disinfect completely. If you double the solution, this concentration allows for contact time of one (1) hour.

6. When the contact time is completed, drain the tank. Refill with potable water and purge the plumbing of all sanitizing solution.

NOTE: The sanitizing procedure outlined above is in conformance with the approved procedures of RVIA ANSI A119.2 and the U.S. Public Health Service.

Note: A petcock, visible between the tires, will drain the tank sufficiently for most purposes. Total drainage may be achieved by removing the large Allen Head Plug located on the bottom of the tank. An access plate must be removed to expose the plug.

AIRSTREAM CLASSIC TRAILER OWNERS MANUAL

CITY WATER HOOK-UP

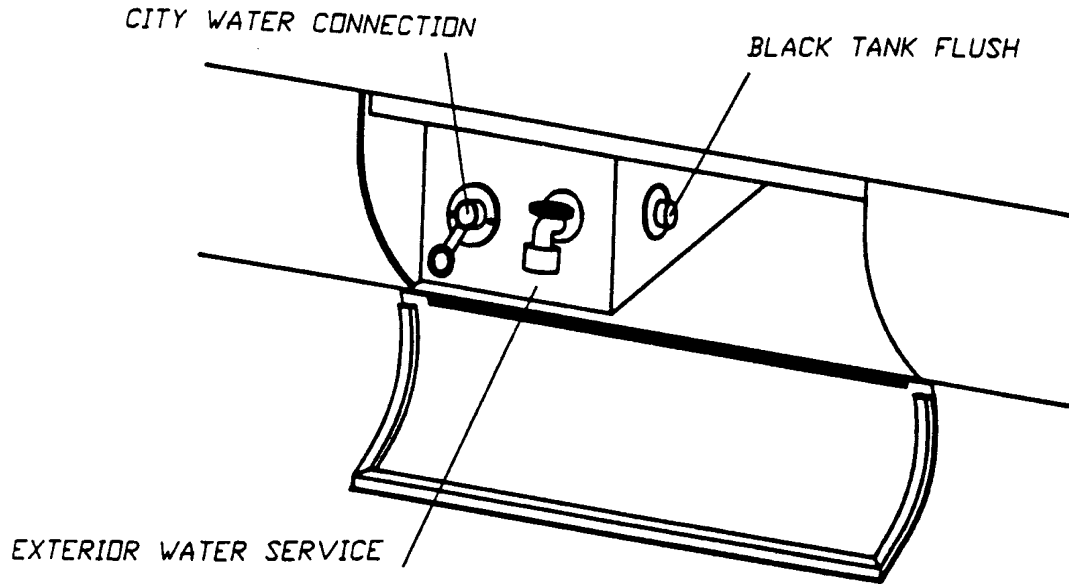

The city water hook-up is found on the lower roadside of the trailer in the utility compartment. A short piece of hose has been provided to extend the city water hookup.

Use a high-pressure hose of at least 1/2" diameter. It should be one that is tasteless, odorless and non-toxic designed for RV use. The city water inlet is a standard garden hose thread. We suggest you carry two lengths of hose. This way you have the ability to reach hookups further away than normal, plus you have a spare hose should one fail or become damaged unexpectedly.

After hooking up the hose and turning on the city water valve provided in the park, slowly open a faucet. There will be a lot of spurts and sputtering until all the air is expelled from the trailer system. If the water heater is empty it will take some time before all the air is expelled and you get a steady flow of water at the faucet. Once a steady flow is achieved at one faucet the others should be opened long enough to expel the air in the lines going to them.

Water pressure at some campgrounds may be low. The water pump can be turned on to assist the city water hookup pressure. Be sure there is some water in the fresh water tank. The pump will only use the water that is needed out of the tank to bring the pressure up to the usual standard.

Your plumbing system has a built in pressure regulator to protect your lines and faucets from extremely high pressures on some city water systems.

EXTERIOR WATER SERVICE

Also in the utility compartment is a hose connection with a shut-off valve. This is plumbed into the high-pressure water system of the trailer. This is an ideal place to rinse the sand off your feet after going to the beach, cleaning mud off your boots and hundreds of other messy jobs that are better done outside of your trailer. During freezing weather this line should be drained. Shut off the valve under the lavatory and leave the exterior valve open.

NOTE: Four valves are located in the lavatory cabinet. Three of these are used as the water heater by-pass system as described in the winterizing section. The fourth valve is for the exterior water service.

AIRSTREAM CLASSIC TRAILER OWNERS MANUAL

BLACK TANK FLUSH

Also in the utility compartment is a water hose connector marked "black tank flush". To use, hook up a hose and turn on full force. Within the tank a spray head with a multiple holed head will spray the interior surface of the tank. The vacuum breaker and check valve will be located inside the trailer above the exterior connection. In most models this will place them under the lavatory.

The gate valve should be closed for the first couple of minutes, and then opened to let the water out in a rush. Repeat as needed.

BLACK TANK FLUSH ASSEMBLY

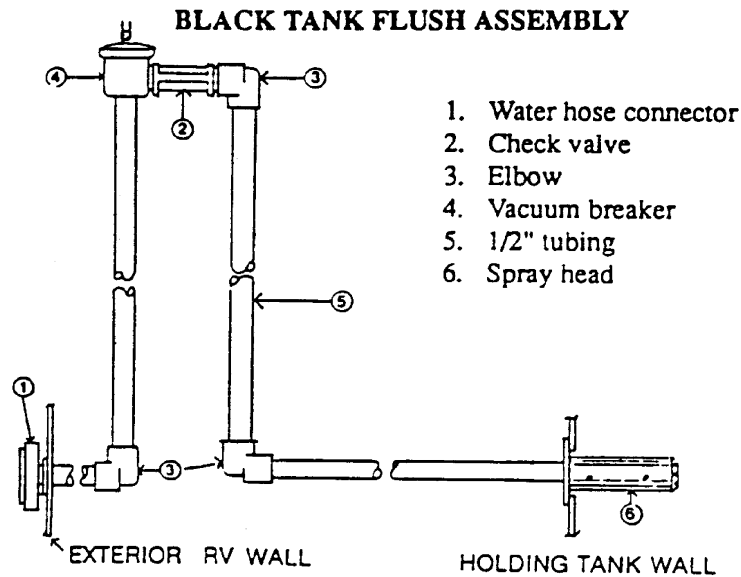

AIRSTREAM CLASSIC TRAILER OWNERS MANUAL

GALLEY FAUCET-MOEN PURETOUCH CLASSIC (Standard)

WATER FILTRATION SAFEGUARDS

Your Moen PureTouch® Classic Filtering Faucet System integrates carbon block filtration technology designed by Culligan International into a faucet spout. This technology is fast and effective at reducing contaminants commonly found in water and is certified by NSF® International. The PureTouch Filtering Faucet System and installation must comply with State and Local laws and regulations. To ensure optimal operation of your new Moen faucet, please read the following safeguards carefully.

MicroTech™ Filter Cartridges

- MicroTech filter cartridges will reduce:
 - Chlorine, Taste and Odor (MicroTech 400, 600)
 - Lead (MicroTech 400,600)
 - Cysts (Cryptosporidium, Giardia) (MicroTech 600)*

*The contaminants removed or reduced by this filter are not necessarily in your water.
- Do not use with water that is microbiologically unsafe or of unknown quality without adequate disinfections before or after the system. Systems certified for cyst reduction may be used on disinfected waters that may contain filterable cysts.
- MicroTech filter cartridges are designed for replacement after dispensing 200 gallons of filtered water. Water conditions and usage may affect filter life and water taste.
- The electronic indicator will signal when filter replacement is necessary
- Use only MicroTech 400 or 600 filter cartridges with the PureTouch *Classic* Filtering Faucet System.
- Filter flow rate = .4-.5 gpm at rated pressure (20 psi min. – 125 psi max.).

Water Temperature

- Minimum/Maximum faucet operating temperature = 40 degrees – 150 degrees F
- **CAUTION: Do not filter water above 100degrees F.**

MicroTech Filter Flushing Instructions

- New MicroTech Filter Cartridge: Allow cold water to run through a new filter for 5 minutes to flush out any loose carbon particles. Once these small black specks are washed out the filter is ready for use.
- Daily Use: Allow cold water to run through the filter for 10-15 seconds prior to first use. If the filter has not been used for two days, run cold water through the filter for 60 seconds prior to use.

Questions

- If you have any questions please call Moen's toll-free help lines:

1-877-DRINK-H2O
Monday through Friday 8:00 a.m. to 8:00 P.M.
1-877-374-6542
Saturday 8:00 a.m. to 6:30 p.m.

AIRSTREAM CLASSIC TRAILER OWNERS MANUAL

PARTS DESCRIPTION

1. Solid Handle Body
2. Set Screw
3. Plug Button
4. Dome & Pivot Retainer Assembly
5. Cartridge Screw
6. Handle Adapter & Connector Assembly
7. Pivot Stop
8. Spout Retaining Nut
9. Bearing Washer
10. "D" Washer
11. Retainer Clip
12. 1225 Cartridge
13. Filter Cartridge
14. Filtering Appliance
15. Lower Spout Assembly
16. Threaded Shank
17. Supply Tubes (2)
18. Bottom Bearing Washer
19. 1/2 " Threaded Fitting
20. Deck Ring with Gasket
21. Deck Plate
22. Mounting Bracket
23. Mounting Nut
24. Designer Spray Head (Spray Models)
25. Hose Guide with Gasket (Side Spray Models)
26. Spray Hose
27. Extended Locknut (Side Spray Models)
28. Swivel Nut (Spray Models)
29. Mounting Tool
30. Deck Plate (Spray in Deck Models)
31. Support Plate with Gasket

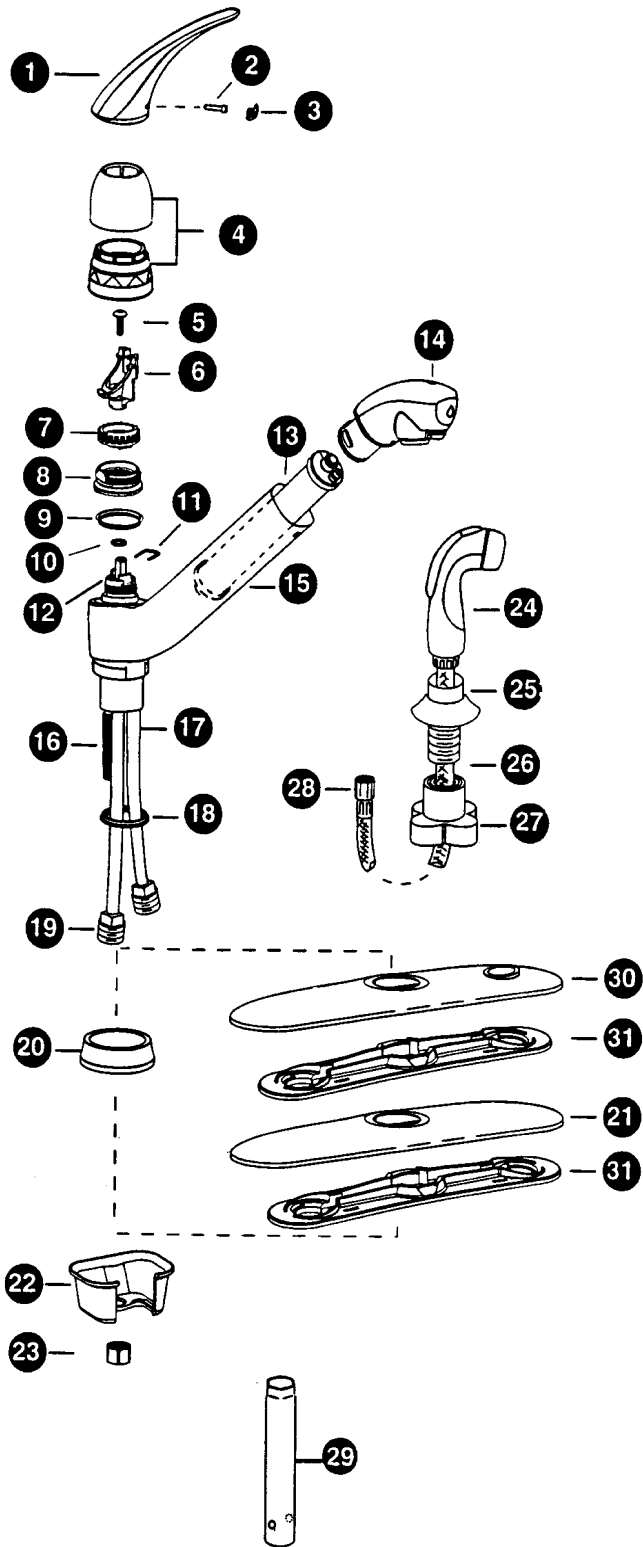

AIRSTREAM CLASSIC TRAILER OWNERS MANUAL

MICROTECH™ FILTER INSTALLATION/REPLACEMENT

1. Install a new filter by wetting the outlet ports with water and then inserting into the round filter ports on the faucet head and pushing the filter and head together. Both outlet ports must be fully inserted into the filter ports.
2. Install the filter and faucet head assembly on to the spout by wetting the faucet head o-ring seal and then carefully sliding the free end of the filter into the spout. The head will need to be initially turned approximately ½ turn counter clockwise from its normal position to slip past the safety catch. Lock the head into place by simultaneously pushing and twisting the head clockwise. When properly installed the head will feel secure, and will be correctly oriented on the spout.
3. Reset the filter life indicator by pushing the filter button 3 times. Wait 10 seconds. You should not be running water while resetting the filter life indicator because the filter button will remain depressed, with the first push as it switches to filter mode. The filter life indicator has been correctly reset if a short series of rapidly flashing green light occurs, indicating that the new filter-flushing period has begun.
4. Flush the filter for 5 minutes before initial use.

Your new Moen faucet is now ready for normal use.

To replace filter:

1. Turn off the faucet. Remove the faucet head by twisting it approximately ¼ turn counter clockwise to unlock it. Gently pull the faucet head away from the spout and twist it approximately another ¼ turn to get the faucet head past the safety catch. The faucet head and depleted filter (if one is installed) can now be pulled completely out of the spout.
2. The filter is held to the faucet head by two outlet ports, which connect into the head. Remove the old filter by simply pulling it straight off. Discard the old filter and install a new MicroTech 400 or 600 filter.

Note: The faucet will function correctly in unfiltered stream mode with or without a filter installed. The faucet will not function correctly in filter mode without a filter. If a filter is not installed and the filter button is depressed, unfiltered water will flow from both the filtered water outlet and the stream outlet aerator, and the filter button will not automatically stay depressed.

Use only Microtech 400 or 600 filter cartridges with the PureTouch Classic Filtering Faucet system. The Microtech filters are high performance carbon block filters developed specifically for the PureTouch system.

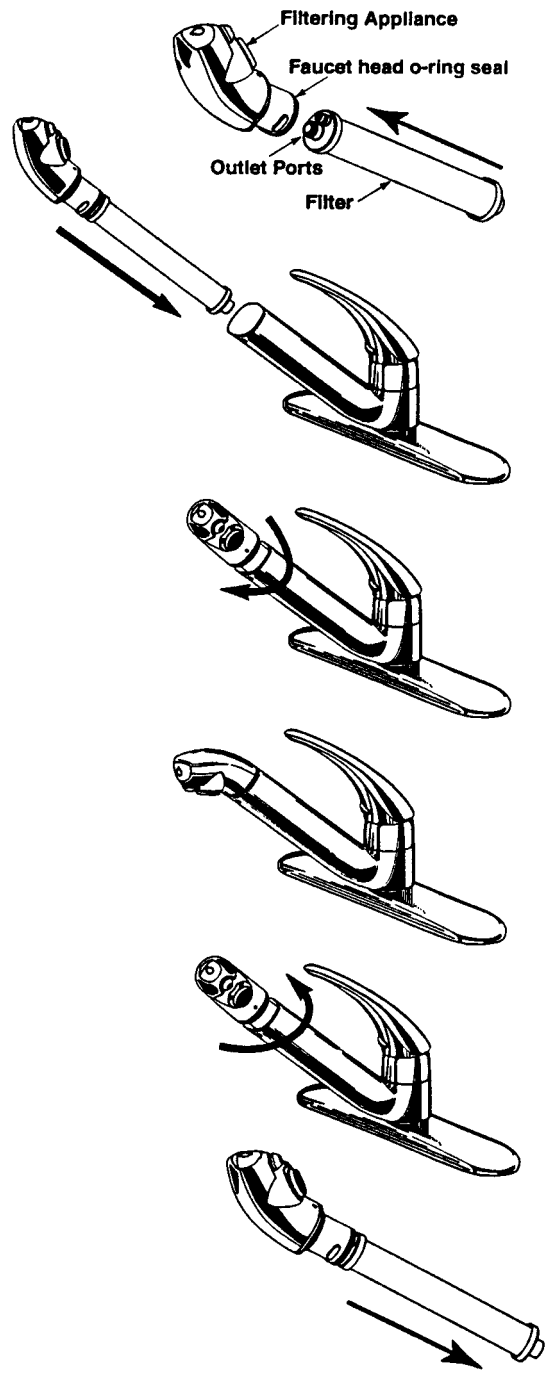

AIRSTREAM CLASSIC TRAILER OWNERS MANUAL

OPERATING INSTRUCTIONS

Controlling The Water

The PureTouch system has two options for water delivery, unfiltered stream and filtered water.

STREAM MODE: Unfiltered water in regular stream flow

When the water is turned on at the faucet, the spout will always begin operating in the regular stream mode.

FILTERED WATER MODE: Filtered water dispensed through the separate filtered water outlet.

Pressing the front filtered water button will divert water through the filter and dispense filtered water from a separate outlet. To exit the filter mode, shut off the faucet.

CAUTION: Only filter cold water. Do not filter water above 100 degrees F.

Electronic Indicator

The flashing light on the electronic filter life indicator provides information regarding the performance of the filter. The indicator provides you with information throughout the life of the filter to help communicate the level at which it is performing.

Indicate Color	Performance
Amber & Green	A new filter must be flushed with cold water for 5 minutes after it is installed. This procedure helps clean the filter of loose carbon particles.
Green	Filter performing at optimum efficiency.
Amber	WARNING: Filter is ready for replacement. (Approximately 16 gallons left.)
Red	WARNING: Filter life is deleted, discard old filter and replace with a new Microtech 400 or 600 filter.

*If fast red doesn't change to slow amber/green after memory has been reset, reset was not complete and needs to be redone. Follow step 3 on the previous page.

A standard replaceable 3V lithium watch battery (2032) designed to last several years powers the electronic indicator.

Battery Replacement

Follow filter replacement instructions to remove filter appliance. Locate battery compartment drawer, pull out and replace battery, positive side up.

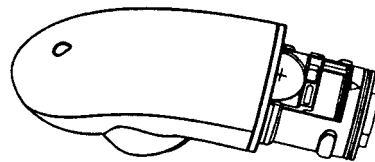

AIRSTREAM CLASSIC TRAILER OWNERS MANUAL

TROUBLESHOOTING

PROBLEM: Water flows from both outlets, filter and unfiltered, when the filter button is pushed.

SOLUTION: No filter is installed. Install a filter.

PROBLEM: After installing a new filter, the filter life indicator still flashes red.

SOLUTION: Filter life indicator was not reset, or the attempt to reset the indicator did not work. Perform reset sequence.

PROBLEM: Reversed Hot & Cold positions,

SOLUTION: HELPFUL HINTS: IT IS NOT NECESSARY TO SHUT OFF WATER SUPPLIES.
HANDLE SCREW REQUIRES A 7/64" HEX KEY WRENCH.

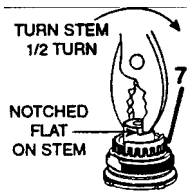

1. Remove plug button (3) from the handle by prying the button upwards from the bottom center. If a tool is required, use something, which will not scratch the handle. Remove set-screw (2), handle body (1), dome and pivot retainer assembly (4), cartridge screw (5), handle adapter and handle connector assembly (6).

2. Turn cartridge stem around so that the notch is turned one half turn or 180 degrees.

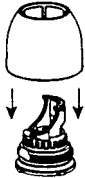

3. Reinstall as follows: Be sure retainer clip (11) is present on cartridge stem and raised edge of pivot stop (7) faces front. Note orientation of handle adapter & connector assembly (6) in the exploded view. Completely tighten cartridge screw (5) to prevent unwanted closure of faucet. Thread on dome clockwise until hand tight. Reinstall handle body (1), set screw (2), and plug button (3).

PROBLEM: Faucet head is loose and water flows freely from between the head and spout.

SOLUTION: The head was not locked in place correctly. Reinstall the head and filter assembly.

PROBLEM: Slow or uneven water flow in filtered mode.

SOLUTION: Filter outlet may be clogged.

1. Remove filter outlet nut, flush out carbon particles.
2. Filter cartridge may be clogged with captured contaminants. Replace filter cartridge. If problem persists call Moen Help line at:

1-877-DRINK-H2O (1-877-374-6542)

PROBLEM: Electronic display doesn't function

SOLUTION: Replace battery.

CARE AND MAINTENANCE

All that is needed to clean your faucet is a soft damp cloth. Moen does not recommend the use of scour pads, cleansers or chemicals. The abrasive nature of these substances could damage the faucet's finish. A non-abrasive car wax will help to protect the finish. **DO NOT SUBMERGE OR PLACE FAUCET HEAD IN DISHWASHER.**

AIRSTREAM CLASSIC TRAILER OWNERS MANUAL

GALLEY FAUCET, MOEN PURETOUCH® (Option Included w/Limited Package) 1-800-374-6542

WATER FILTRATION SAFEGUARDS

Your Moen PureTouch® Filtering Faucet System integrates carbon block filtration technology designed by Culligan International into a faucet spout. This technology is fast and effective at reducing contaminants commonly found in water and is certified by NSF International. The PureTouch Filtering Faucet System and installation must comply with State and Local laws and regulations. To ensure optimal operation of your new Moen faucet, please read the following safeguards carefully.

MicroTech™ Filter Cartridges

- MicroTech filter cartridges will reduce:
 - Chlorine, Taste and Odor (MicroTech 5000, 3000, 1000)
 - Lead (MicroTech 5000,3000)
 - Cysts (Cryptosporidium, Giardia) (MicroTech 5000)*

*The contaminants removed or reduced by this filter are not necessarily in your water.
- Do not use with water that is microbiologically unsafe or of unknown quality without adequate disinfections before or after the system. Systems certified for cyst reduction may be used on disinfected waters that may contain filterable cysts.
- MicroTech filter cartridges are designed for replacement after dispensing 200 gallons of filtered water (approximately 3 months). Water conditions and usage may affect filter life and water taste.
- The electronic indicator will signal when filter replacement is necessary
- Use only MicroTech filter cartridges with the PureTouch Filtering Faucet System.
- Filter flow rate = .4-.5 gpm at rated pressure (20 p.s.i. min. – 125 p.s.i. max.).

Water Temperature

- Minimum/Maximum faucet operating temperature = 40 degrees – 150 degrees F
- **CAUTION: Do not filter water above 100 degrees F.**

MicroTech™ Filter Flushing Instructions

- New MicroTech Filter Cartridge: Allow cold water to run through a new filter for 5 minutes to flush out any loose carbon particles. Once these small black specks are washed out the filter is ready for use.
- Daily Use: Allow cold water to run through the filter for 10-15 seconds prior to first use. If the filter has not been used for two days, run cold water through the filter for 60 seconds prior to use.

Questions

- If you have any questions please call our toll-free help line:

1-800-BUY-MOEN

Monday through Friday	8:00 a.m. to 8:00 p.m.
Saturday	8:00 a.m. to 6:30 p.m.

AIRSTREAM CLASSIC TRAILER OWNERS MANUAL

PARTS DESCRIPTION

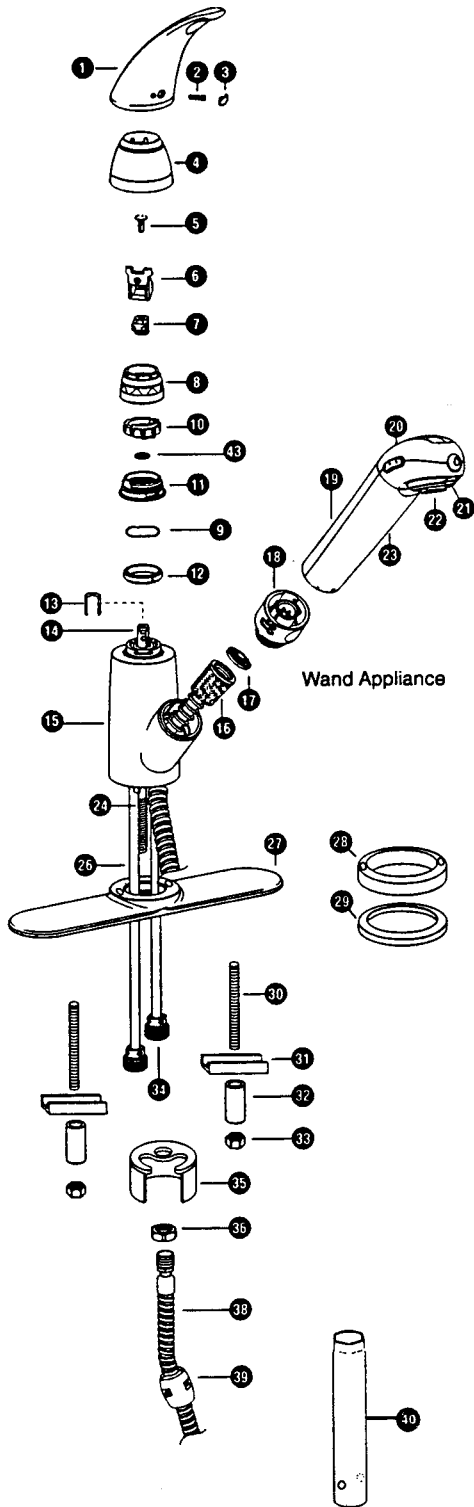

1. Solid Handle Body
2. Set Screw
3. Plug Button
4. Dome
5. Cartridge Screw
6. Handle Adapter
7. Handle Connector
8. Pivot Retainer
9. Wave Spring Washer
10. Pivot Stop
11. Retainer Nut
12. Bearing Washer
13. Retainer Clip
14. 1225 Cartridge
15. Spout Receptor
16. Hose Connection
17. Screen Washer
18. Quarter Turn Connector
19. Pull-out Spout
20. Upper Housing Unit
21. Filter Outlet Nut
22. Aerator
23. Filter Cover
24. Threaded Discharge Tube
25. Bottom Bearing Washer
26. Supply Tubes (2)
27. Deck Plate
28. Deck Ring
29. Ring Gasket
30. Deck Plate Studs (2)
31. Clamp Bar (2)
32. Spacer (2)
33. Small Mounting Nut (2)
34. 1/2" Threaded Fitting (2)
35. Mounting Bracket
36. Medium Mounting Nut
37. Adapter
38. Spout Hose
39. Counter Weight
40. Mounting Tool
41. Filter (not shown)
42. Large Mounting Nut (2) (not shown)
43. Washer

AIRSTREAM CLASSIC TRAILER OWNERS MANUAL

OPERATING INSTRUCTIONS

Controlling The Water

The PureTouch System has three options for water delivery; unfiltered stream, unfiltered spray and filtered water.

The spray and stream actuating buttons are on the sides of the pullout spout; the filtered water button is located on the front of the spout.

Stream/Spray flow rate =

2.2 gpm maximum at 60psi

2.5 gpm maximum at 80 psi.

STREAM MODE: Unfiltered water in regular stream flow.

When the water is turned on at the faucet, the spout will always begin operating in the regular stream mode.

SPRAY MODE: Unfiltered water in a wide pattern. If a wide spray mode is desired, push the spray button while the water is on. To return to stream mode, push the stream button.

FILTERED WATER MODE: Filtered water dispensed through the separate filtered water outlet. Pressing the front filtered water button will divert water through the filter and dispense filtered water from a separate outlet. The only way to exit the filter mode is to shut the faucet off.

CAUTION: Only filter cold water. Do not filter water above 100 degrees F.

Electronic Indicator

The electronic indicator provides the following visual and audible feedback on the filtering system

- Successful installation of a new filter (audible & visual)
- Percent of filter life remaining (visual)
- Filter is actively filtering water (visual)
- Low filter warning (audible & visual)
- Depleted filter warning (audible & visual)
- Low battery warning (audible & visual)

The electronic indicator is powered by a replaceable standard 3V lithium watch battery (2032) designed to last several years.

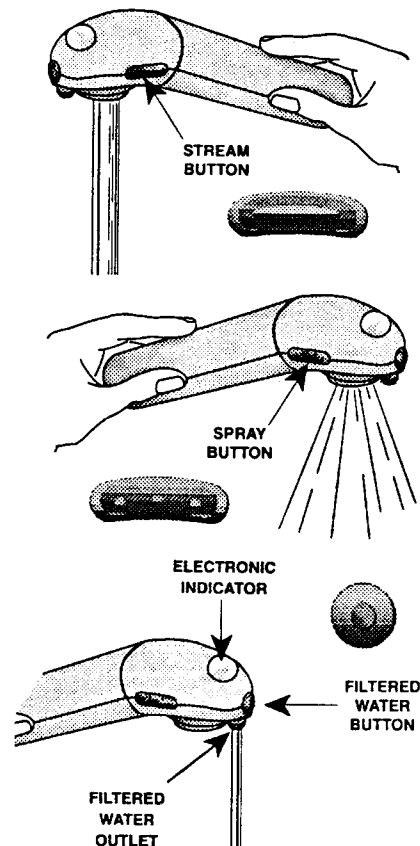

AIRSTREAM CLASSIC TRAILER OWNERS MANUAL

MICROTECH™ FILTER INSTALLATION

NOTE: Faucet will not operate in any mode without filter. Filter should be left in protective bag until ready for installation. The MicroTech™ filter is a high performance carbon block filter developed specially for the PureTouch Filtering Faucet System. **Once the filter is installed in the pullout spout, it should not be removed until it is to be replaced. The electronic module keeps track of the amount of filter life remaining and will signal you when the filter change is necessary. If a partially used filter is removed and reinstalled, the electronic indicator will automatically reset and will not accurately reflect filter life remaining.**

Use only Microtech filter cartridges with the PureTouch Filtering Faucet System.

1. Remove the filter cover by lifting it up and away from the pullout spout body.
2. Insert the new filter by aligning the outlet tubes on the filter with the inlet ports of the spout body and gently pressing in and down. Upon successful installation of the filter cartridge, the filter life indicator will beep three times and reset automatically. **(Do not remove the filter until it is to be replaced.)**
3. Re-install the filter cover by positioning the alignment tab with the corresponding notch in the main pullout spout body and gently pushing in and down.
4. Attach the pullout spout to the hose by aligning the dots on the quarter turn connector (18) and the spout. Push the quarter turn connector onto the spout assembly and turn it clockwise, locking it in place.
5. Allow cold water to run through the new filter for 5 minutes to flush out any loose carbon particles. Once these small black particles are washed out the filter is ready for use.

The PureTouch System installation is now complete. Please read carefully the operation instructions to ensure optimal performance.

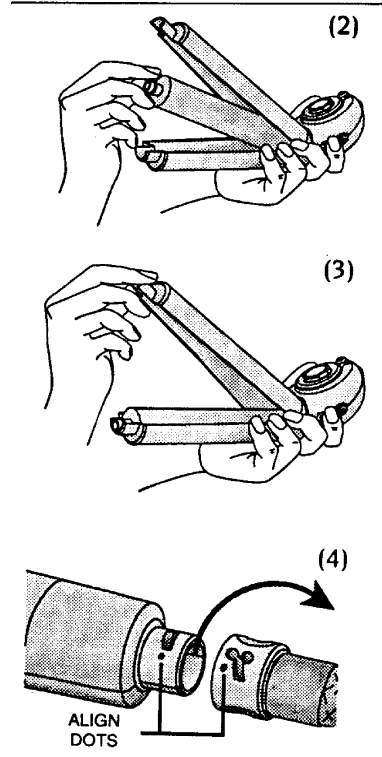

CARE AND MAINTENANCE

All that is needed to clean your faucet is a soft damp cloth. Moen does not recommend the use of scour pads, cleansers or chemicals. The abrasive nature of these substances could damage the faucet's finish. A nonabrasive car wax will help to protect the finish. **DO NOT PLACE WAND APPLIANCE IN A DISHWASHER.**

AIRSTREAM CLASSIC TRAILER OWNERS MANUAL

OPERATING INSTRUCTIONS

Successful Installation of a new Filter

When the depleted filter is replaced with a new filter three beeps are sounded and the 100% filter life is displayed momentarily. The new filter has been successfully installed and the electronic indicator has reset.

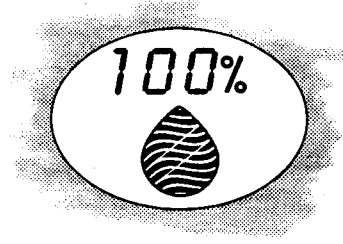

Percent of Filter Life Remaining

As the filter is used the indicator counts down to zero from 100%. The percentage remaining is displayed when water is being filtered. Additionally, the filter status can be checked without the faucet being turned on by momentarily pressing the filter button.

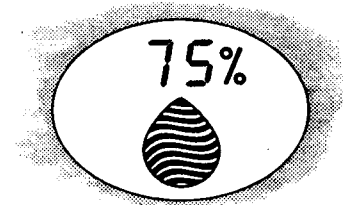

Filter is Actively Filtering Water

The water drop icon cycles when water is being filtered.

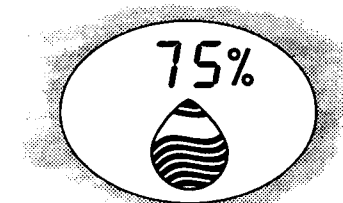

Low Filter Warning

There are two low filter warnings, one at 5% remaining filter life and 1% remaining life. When the remaining filter life reaches 5% the low filter icon blinks and three beeps are sounded when the filter button is depressed. At 1% or less the low filter icon blinks and beeps are sounded every 5 seconds while water is being filtered indicating it is time to change the filter.

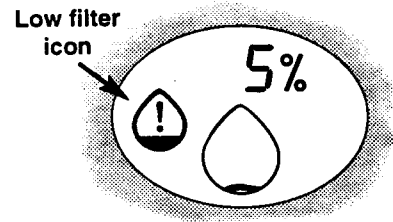

Depleted Filter Warning

When the filter life remaining reaches 0%, the depleted filter icon blinks and beeps are continuously sounded while water is being filtered. The filter mode should not be used until a new filter is installed.

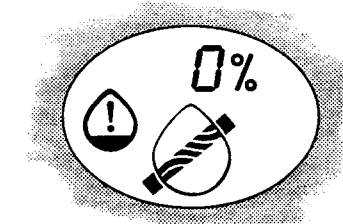

Low Battery Warning

A standard 3V lithium watch battery designed to last several years under normal usage powers the electronic indicator. When a low battery condition is detected the low battery icon blinks and beeps are sounded while water is being filtered indicating it is time to change the battery.

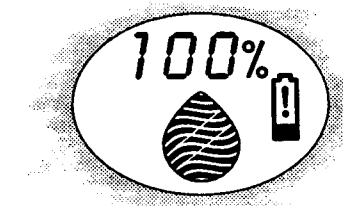

AIRSTREAM CLASSIC TRAILER OWNERS MANUAL

OPERATING INSTRUCTIONS

Helpful Tools: large flat tip screwdriver, small Phillips screwdriver (#1).

Battery and Upper Housing Replacement

1. With faucet off, push filtered water button and record percentage of remaining usable filter life. When battery is changed, filter life indicator automatically resets to 100%. Record here _____.

2. Remove pullout spout (19) from receptor (15) and tie a dishtowel around the hose to keep it from slipping back into the spout receptor.

3. Disconnect the quarter turn connector (18) from spout by turning it counterclockwise one-quarter turn. The quarter turn connector will remain attached to the hose.

4. Remove filter cover by lifting up and away from main spout assembly. Remove filter cartridge from main spout assembly by lifting from the inlet tube, using same up and away motion. **NOTE: Excess water may dribble from cartridge and valving. Dry pullout spout with towel to prevent electronics from becoming wet.**

5. With large flat screwdriver or dime, unscrew (counterclockwise) and remove filter outlet nut (21).

6. With Phillips screwdriver unscrew (counterclockwise) and remove two short lower housing screws. Carefully remove lower housing cover.

7. Unscrew (counterclockwise) and remove three upper housing screws. Carefully lift upper housing cover off of wand appliance leaving rubber button covers in place.

8. Battery should now be exposed on upper side of spout. Remove old battery from battery compartment and dispose of properly.

9. Install new 2032 battery with positive side up. When battery is properly installed, filter life indicator will light momentarily. Activate electronic indicator by pressing filtered water button to ensure proper battery installation. Display should be visible.

10. Reinstall upper housing cover by carefully aligning over button covers.

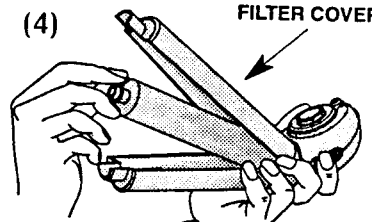
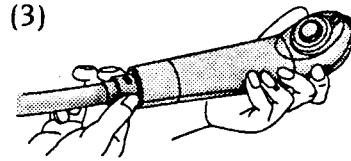
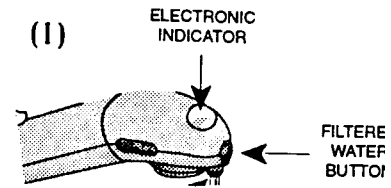

(5 & 14)

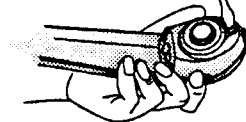

(6 & 13)

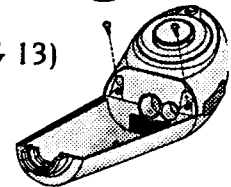

(6 & 12)

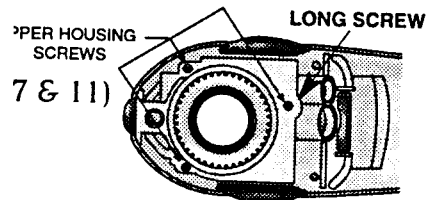
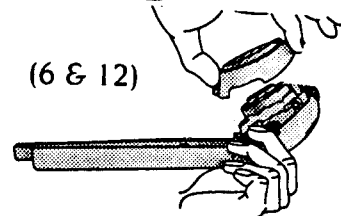

(7 & 10)

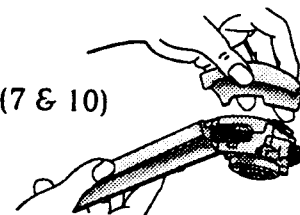

AIRSTREAM CLASSIC TRAILER OWNERS MANUAL

NOTE: When reinstalling screws and filter outlet nut, insert into hole, turn counter clockwise with screwdriver until a click is felt then turn clockwise until snug. DO NOT OVER TIGHTEN!

11. Reinstall 2 short and 1 long upper housing screws until snug. Refer to picture (7 & 11) on previous page for placement of long screw. **DO NOT OVER TIGHTEN!**

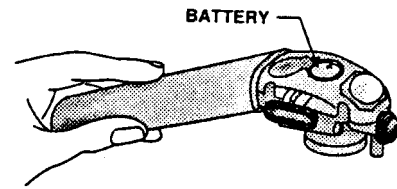

NOTE: To assist in aligning lower housing, press side buttons slightly while sliding housing in place.

12. Reinstall lower housing by carefully aligning over button covers.

13. Reinstall two short housing screws until snug. **DO NOT OVER TIGHTEN!**

14. Reinstall filter outlet nut (21) with flat screwdriver. **DO NOT OVER TIGHTEN!**

15. Insert filter by aligning outlet tubes with inlet ports on main pullout spout assembly and gently pushing in and down. Upon successful installation of filter cartridge, pullout spout will emit a series of three beeps and filter life indicator will reset automatically.

16. Reinstall filter cover by positioning alignment tab over corresponding notch in main pullout spout assembly and gently pushing in and down.

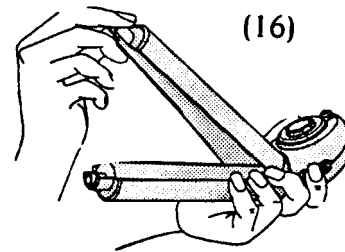

17. Reattach quarter turn connector (18) to pullout spout (19) aligning the dots on the quarter turn connector and the spout. Push the quarter turn connector onto the spout assembly and turn it clockwise, locking it in place. Return spout to the receptor.

18. If new filter was not installed at battery change, refer to remaining filter life previously recorded at beginning of battery replacement. Subtract recorded number in step 1 from the 100% displayed. The difference represents the display setting at which the current filter will need replacement. Filter may not perform as desired after this calculation percentage.

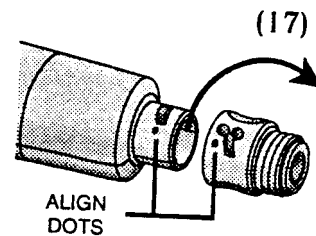

Example: Remaining filter life prior to battery change equals 30%.

Subtract 30% from 100% (100-30=70)

Filter will need to be changed when indicator reads 70%

AIRSTREAM CLASSIC TRAILER OWNERS MANUAL

FILTER REPLACEMENT

MicroTech™ replacement filter cartridges may be purchased at the same location as the faucet. For the dealer nearest you, call 1-800-BUY-MOEN. Use only MicroTech filter cartridges with the PureTouch® Filtering Faucet System.

Do not remove the filter until it is to be replaced.

1. Remove pullout spout (19) from receptor (15) and tie a dishtowel around the hose to keep it from slipping back into the spout receptor.

(2)

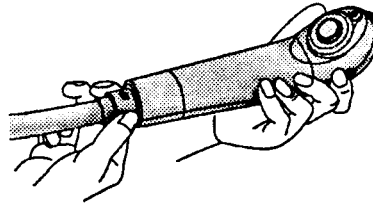

2. Disconnect the quarter turn, connector (18) from pullout spout by turning it counterclockwise one-quarter turn. Quarter turn connector will remain on the hose.

3. Remove the filter cover by lifting up and away from pullout spout assembly. Remove the filter by lifting up and away from the pullout spout assembly. **NOTE: Excess water may dribble from cartridge and valving.**

(3)

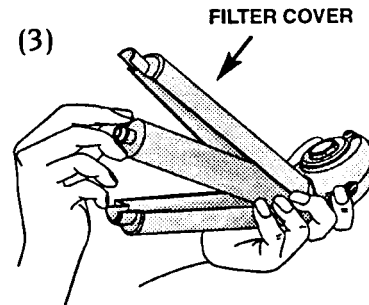

4. Using soft towel or cloth, wipe excess water from wand appliance.

5. Insert the new filter by aligning the two outlet tubes on the filter with the two inlet ports on the spout body and gently pressing in and down. Upon successful installation of the filter cartridge, the pullout spout will beep three times and the filter life indicator will reset automatically.

(6)

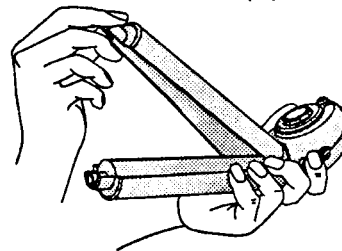

6. Reinstall the filter cover by positioning the alignment tab with the corresponding notch in the main pullout spout body and gently pushing in and down.

7. Reattach the filtering pullout spout to the hose by aligning the dots on the quarter turn connector (18) to the pullout spout (19). Push the quarter turn connector onto the spout assembly and turn it clockwise locking it in place.

(7)

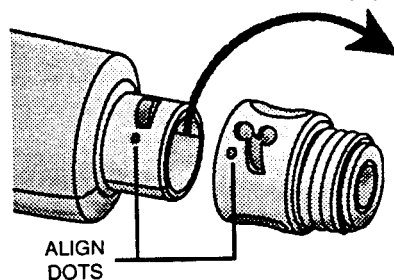

8. Allow water to run through the new filter for 5 minutes to flush out any loose carbon particles. After these small black particles are washed out the filter is ready to be used.

AIRSTREAM CLASSIC TRAILER OWNERS MANUAL

TROUBLESHOOTING

PROBLEM: Water drips from hose and quarter turn connection

SOLUTION: Make sure screen washer (17) is in place.

PROBLEM: Slow or uneven water flow in unfiltered modes.

SOLUTION: The screen washer has become clogged. Ensure faucet handle is in a closed position. Remove pullout spout from receptor and tie a rag around the hose to keep it from slipping back into the spout receptor. Disconnect the quarter turn connector (18) from hose connection (16). Remove screen washer (17) from hose connection. Clean screen washer with a toothbrush and rinse.

PROBLEM: Reversed Hot & Cold positions.

SOLUTION: HELPFUL HINTS: IT IS NOT NECESSARY TO SHUT OFF WATER SUPPLIES. HANDLE SCREW REQUIRES A 7/16" HEX KEY WRENCH.

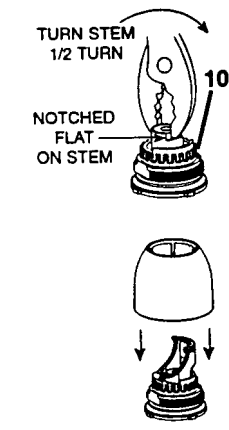

1. Remove plug button (3) from the handle by prying the button upwards from the bottom center. If a tool is required, use something which will not scratch the handle. Remove setscrew (2), handle body (1), dome (4), cartridge screw (5), handle adapter (6) and handle connector (7).

2. Turn cartridge stem around so that the notch is turned one half turn or 180 degrees.

3. Reinstall as follows: Be sure retainer clip (13) is present on cartridge stem and raised edge of pivot stop (10) faces front. Note orientation of handle adapter & connector assembly (6 & 7) in the exploded view. Completely turn cartridge screw (5) to prevent unwanted closure of faucet. Thread on dome clockwise until hand tight. Reinstall handle body (1), set screw (2) and plug button (3).

PROBLEM: Pullout hose does not move freely.

SOLUTION: Gently bend supply tubes away from the hose. DO NOT KINK SUPPLY TUBES

PROBLEM: Slow or uneven water flow in filtered mode.

SOLUTION: Filter outlet nut (21) may be clogged

1. Remove filter outlet nut, flush out carbon particles.
2. Filter cartridge may be clogged with captured contaminants Replace filter cartridge. Call Moen Help line at 1-800-BUY-MOEN if problem persists.

PROBLEM: Water drains from sides of pullout spout when water is on

SOLUTION: Filter may be cracked. Replace filter.

PROBLEM: Electronic display doesn't function.

SOLUTION: Replace battery.

AIRSTREAM CLASSIC TRAILER OWNERS MANUAL

MOEN FAUCET CARTRIDGE REPLACEMENT

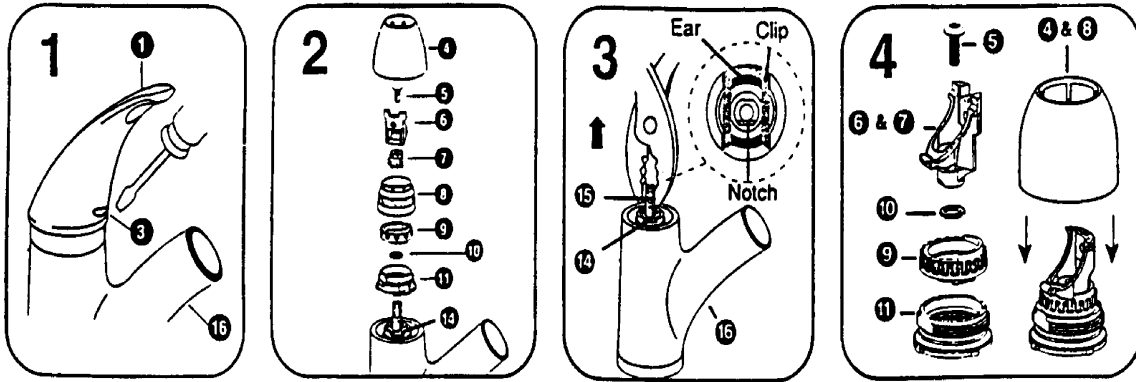

CAUTION: Always turn water OFF before removing existing faucet or disassembling the valve. Open faucet handle to relieve water pressure and ensure that complete water shut-off has been accomplished.

1. Remove plug button (3) from the handle by prying the button upwards from the bottom center. Be careful not to scratch the handle. Lift the handle up and using a 7/64" hex wrench, remove set screw (2). Remove handle (1), unscrew dome and pivot retainer (4 & 8), cartridge screw (5), handle adapter & connector assembly (6 & 7), and pivot stop (9). Remove DD washer (10) and retainer nut (11).

2. Using a flathead screwdriver, remove the retainer clip (14).

3. Grasp cartridge stem with pliers and pull cartridge (15) straight up and out of valve body.

4. Reinstall as follows: Install cartridge (15) into valve body with notched flat on stem facing forward. Be sure to position the ears of the cartridge in the front and back. Reinstall the retainer clip (14), which straddles the ears on the cartridge. Reinstall the retainer nut (11) and pivot stop (9) with the stop in front as shown in Step 4 above. Reinstall DD washer (10) and reassemble handle connector and handle adapter (6 & 7). Note orientation of this sub-assembly as shown in Step 4. Install cartridge screw (5). Be sure to install completely to prevent unwanted closure of faucet. Thread on dome and pivot retainer (4 & 8) clockwise until hand tight. Reinstall handle (1), set screw (2), and plug button (3).

AIRSTREAM CLASSIC TRAILER OWNERS MANUAL

Moen Two Handle Lavatory Faucet

Moen Model 4720

USA
Moen Inc.
25300 AL Moen Dr
North Olmstead, OH. 44070-8022
1-800-Buy-Moen (289-6636)

Canada
Moen Inc.
2816, Route Bristol, Oakville
Ontario, L6H5S7
1-800-465-6130, Toronto: 905- 829-3400

Care Instructions for the Non-Tarnish Finish

As with any fine polished surface, your faucet will retain its shine for years to come with proper care. The LifeShine™ finish on this faucet does not require the extraordinary work needed to maintain most fine polished brass finishes.

Be sure to read and follow usage instructions enclosed with any scour pad or scrub sponge before use.

- **Caution:** Do not use pads or sponges that specifically do not recommend use for cleaning polished surfaces.
- **Caution:** Many pads or sponges with green fibrous surface (such as Scotch-Brite™ heavy duty scrub sponges) contain microscopic mineral particles that can scratch nearly all polished surfaces, including this faucet finish.

The LifeShine™ finish can be cleaned with most household cleaners (including mild abrasives), when used according to their manufacturers instructions for use.

- Rinse any strong cleaners off immediately after use to maintain the LifeShine™ finish luster. Mild scrubbing with fine steel wool (0000 grade) can remove built up dirt or water stains.

Visible water spots on this highly lustrous and reflective finish can be easily wiped off with a cloth dampened with water or with glass cleaner.

Moen Cartridge Removal

CAUTION: Always turn water OFF before removing or disassembling the valve. Open valve handles to relieve water pressure to insure that complete water shut-off has been achieved.

1. Holding the handle (2) or (18) with one hand, unscrew the handle hub (9) counterclockwise and set aside.
2. Unscrew the cartridge nut (11) counterclockwise.
3. Grasp the cartridge stem with pliers being careful not to damage stem and pull straight up.

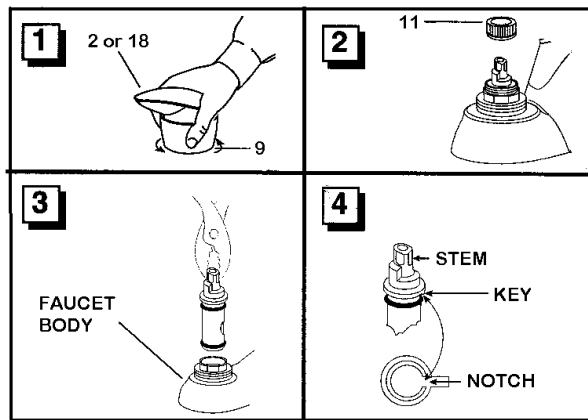

4. To reassemble, reverse the previous steps. Turn the cartridge stem to ON position, so that the hole in the piston lines up with the hole in the outer shell. Push the cartridge straight down into the body making sure the key on the cartridge fits into the notch in the body. This will correctly position the cartridge. Replace the cartridge nut, start by hand, **DO NOT CROSS THREAD**, and tighten firmly.

AIRSTREAM CLASSIC TRAILER OWNERS MANUAL

Moen Two Handle Lavatory Faucet

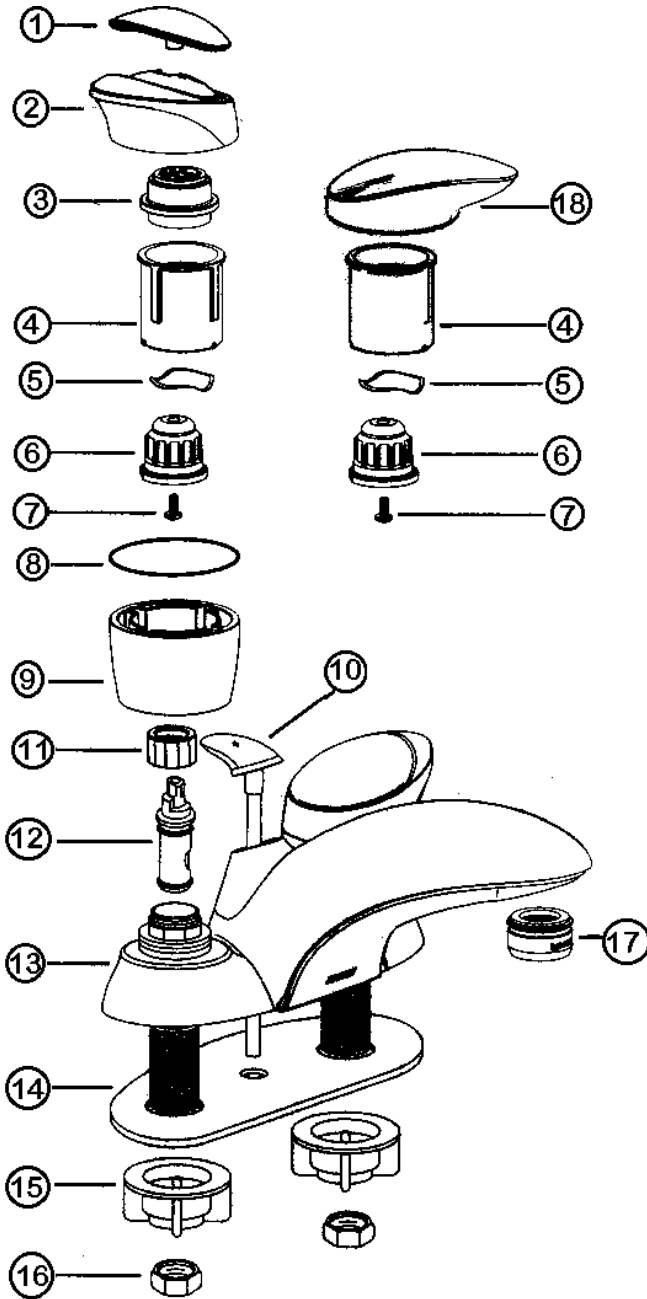

Parts List

1. Cap
2. Knob Handle
3. Knob Handle Adapter
4. Chassis
5. Wave Washer
6. Handle Adapter
7. Screw Handle Adapter
8. Temperature Indicator
9. Handle Hub
10. Lift Rod & Knob
11. Cartridge nut
12. Cartridge
13. Escutcheon
14. Gasket
15. Mounting Nut/Washer
16. Nut
17. Aerator
18. Lever Handle

In the US call Moen's toll free Help line number, 1-800-Buy-Moen (289-6636) for answers to any product, warranty, or installation questions.

In Canada call 1-800-465-6130, Toronto: 905- 829-3400.

AIRSTREAM CLASSIC TRAILER OWNERS MANUAL

MOEN SHOWER MIXING VALVE ASSEMBLY

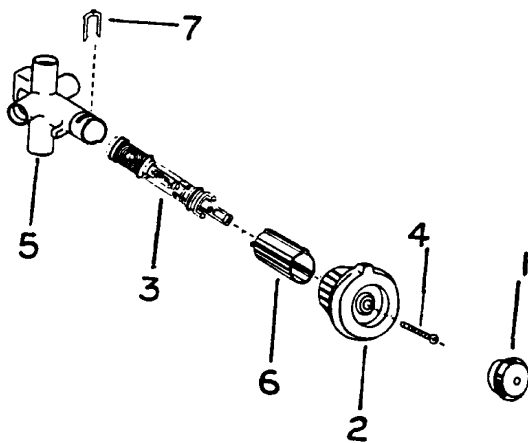

1. Handle Cover
2. Handle
3. Cartridge
4. Handle Screw
5. Valve Body
6. Stop Tube
7. Retainer Clip

SHOWER MIXING VALVE CARTRIDGE REMOVAL

Shut off water pressure for entire system.

Disassemble: Remove handle cover. Take out handle screw and remove handle and stop tube, Lift out retaining clip and pull the cartridge out of the body by the stem.

CAUTION: Reinsert cartridge by pushing it all the way into the body and until the front of the ears on the cartridge shell are flush and aligned with the body. Replace the retainer clip so that the legs straddle the cartridge ears and slide down into the bottom slot in the body. This prevents the cartridge from rotating and locks it in the body. Reinstall stop tube and handle. Tighten handle screw securely, and replace the handle cover. The red flat on the stem must point UP when mounting the knob handle (down for lever handle).

If cold water is on left side and hot water is on right side (red flat pointed down), remove cartridge and reinstall 180 degrees.

AIRSTREAM CLASSIC TRAILER OWNERS MANUAL

DRAIN VALVES

The line drain valves have been moved to the exterior of the coach for easier access. If you look between your tires you can see a galvanized "box" that is a few inches lower than the trailer frame. This "box" or pan supports the water tank.

The line drains will be the two brass petcocks extending from the end of the pan. The white plastic petcock you will see is to drain the water tank.

To Empty Fresh Water Tank

Pumping the water out with the self-contained water pump may empty the fresh water tank. Simply turn on the pump switch and open a couple of faucets until the water will no longer come out. On all models there is also a petcock type drain valve located in the wheel well and extended out through the tank support pan.

An additional drain plug is located on the bottom of the tank, accessible under the inspection plate close to the petcock that can be seen on the bottom of the tank support pan.

Note: For winterizing purposes, only the petcock behind the tires needs to be opened to drain the tank.

Water Heater Draining

All models have a drain plug or petcock on the water heater. Access is from the exterior. The plug or valve is usually located in the lower left corner, viewed as you face the exterior of the water heater.

WATER VALVES

Your Airstream has five other water valves. These valves are all found in the lavatory cabinet

In some cases, they can be found by opening the lavatory cabinet door and in other units the cabinet drawers may have to be removed in order to see the valves.

Three of the valves are for bypassing the water heater when winterizing using the anti-freeze method as described in the following pages.

Another of the valves is in the line to your exterior water service valve on the outside of your trailer. In freezing temperatures, the exterior valve can be damaged. In these temperatures shut off the valve in the lavatory cabinet and open the exterior valve. This drains the water in the exterior valve so freezing won't damage it.

The fifth valve is used to shut water off to the toilet in an emergency or service situation. On some units it is located inside the lavatory cabinet, on most units it is located just behind the toilet close to the floor.

AIRSTREAM CLASSIC TRAILER OWNERS MANUAL

WINTERIZING AND STORAGE

When storing your trailer for short or long periods use the same precautions as you would in your own home in regard to perishables, ventilation and rain protection. In addition, for prolonged storage periods flush out all the drain lines and the holding tanks. Also drain the entire water system including the water heater and the water storage tank. Instructions for draining the water system are explained in the following paragraphs on winterizing.

THE MAIN CONSIDERATION IN WINTERIZING IS TO GUARD AGAINST FREEZE DAMAGE TO THE HOT AND COLD WATER SYSTEMS, THE WASTE DRAIN SYSTEM (INCLUDING THE TRAPS), AND THE WATER HOLDING TANKS, THE WATER HEATER AND THE BATTERY.

To completely winterize your trailer follow this procedure.

1. Level the trailer from side to side and front to rear. Open all faucets
 2. Turn the water pump switch to the ON position to expel water from the storage tank
 3. Open all drain valves including drain plug or valve on water heater and exterior water service valve. (See drain valves on previous page)
 4. While the water is draining from the system, open and flush the toilet-flushing valve. Depress hand spray lever while holding the spray head down inside the bowl. Depress hand spray thumb button on the telephone showerhead while holding down inside the tub and drain all water from the flexible hose. Unscrew the heads on both spray units and store.
 5. Turn the pump switch OFF after all water has been removed from the storage tank.
 6. Remove exhaust hose from water pump.
 7. Disconnect the water pump inlet connection and turn the pump on until all the water is expelled. This water, about 1/2 cup, can be caught in a towel or rag.
 8. Lower the front of the trailer as far as the jack will allow until water ceases to drain, then crank the jack up as high as it will go and let any remaining water drain out.
 9. After the water has stopped running from the drain lines, apply at least 60 lbs, of air pressure at the city water inlet. An air to city water adapter is available from your dealer's RV accessory store. Be sure the toilet valve and all drain valves and faucets are open and pump outlet hose is disconnected. This can be accomplished at a service station and will force any remaining water from the water heater and remove any water which may be trapped in low areas.
 10. Pour a cup of *approved non-toxic RV antifreeze into the lavatory, sink and tub drains to prevent trap freeze-up.
- *Approved and listed by a recognized testing authority such as UL (Underwriter Lab).
11. Be sure to open the waste holding tank drain valves and drain and flush the tanks thoroughly (THIS IS VERY IMPORTANT AS THE SEWAGE IN THE TANKS, IF FROZEN, COULD SERIOUSLY DAMAGE THE TANKS.)

AIRSTREAM CLASSIC TRAILER OWNERS MANUAL

12 Remove the cartridge of the water purifier and leave the purifier valve in the open position. (If so equipped.)

13. Remove the batteries from your trailer and store in a cool dry place where there is no danger of freezing. It is very important for optimum life of a battery to check it periodically and to keep it fully charged.

14. Remove any items (food, cosmetics, etc.) from trailer interior that might be damaged by freezing - or might damage the trailer if containers break.

For additional winterizing protection add a non-toxic antifreeze (approved for drinking water system) to the water lines using the following procedure.

1.Reconnect all lines except the hose to the pump inlet port. Close all drain valves.

2* Turn by-pass valve to by-pass position. Access to the by-pass valves is in the lavatory cabinet. If your trailer has rear twin beds valve access may be through the exterior storage door just to the rear of the water heater.

3. Attach a length of hose to the pump inlet port. This piece of hose should be long enough for the free end to be inserted into and reach the bottom of the antifreeze container.

4. Dilute the antifreeze solution in accordance with the manufacturer's instructions

5. Open all water faucets.

6. Insert hose length into the antifreeze container, turn the pump switch on, and run the water pump until the antifreeze solution fills all water lines. Flush toilet. Work hand shower spray while holding down in tub.

7. Shut off the pump and close all faucets.

8. Disconnect the hose length from pump inlet fitting and reconnect water system inlet line.

*To by-pass the water heater for winterizing, close valves A and C and open valve B (See illustration).

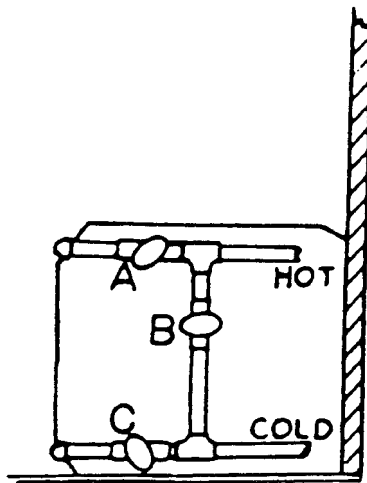

AIRSTREAM CLASSIC TRAILER OWNERS MANUAL

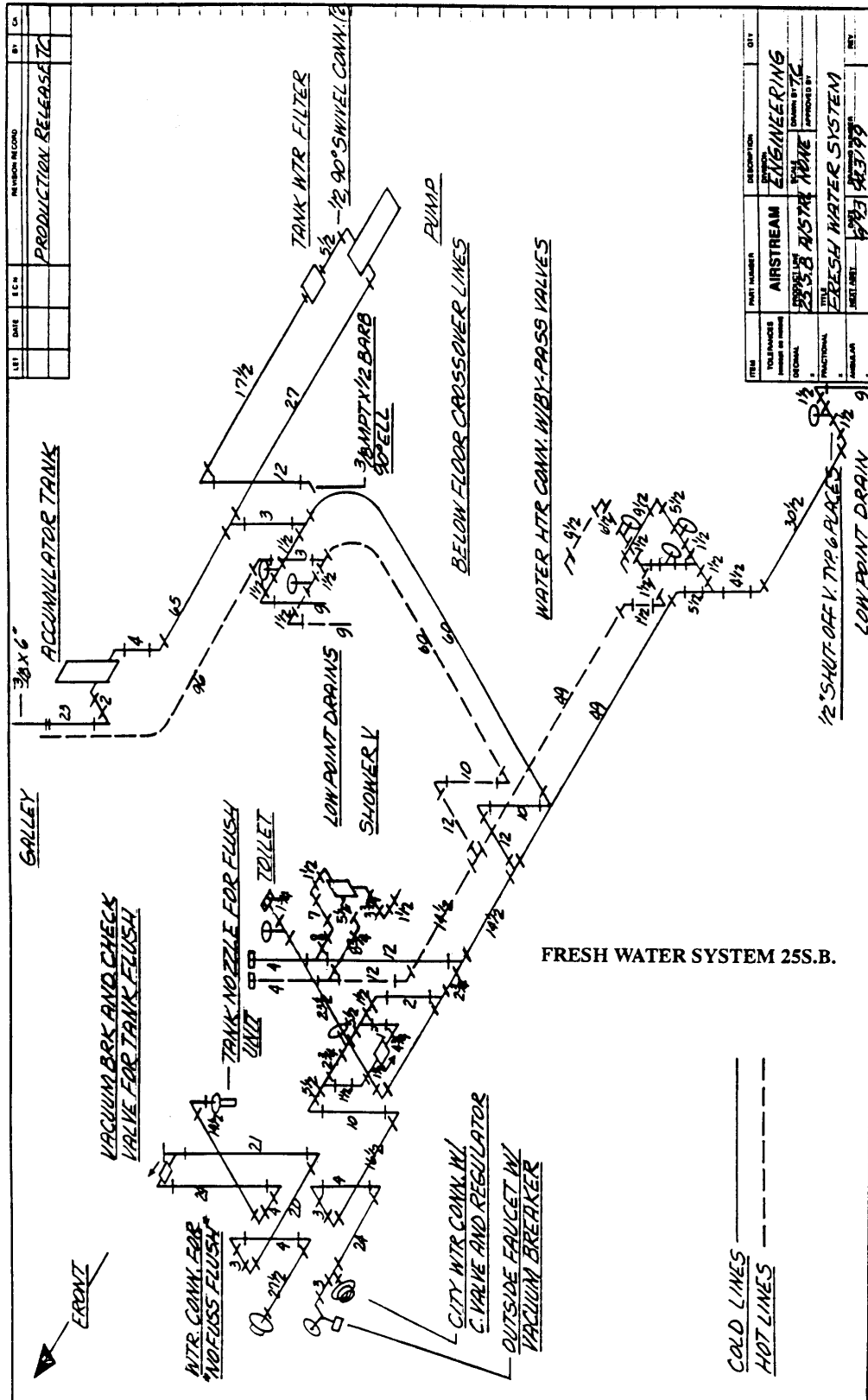

AIRSTREAM CLASSIC TRAILER OWNERS MANUAL

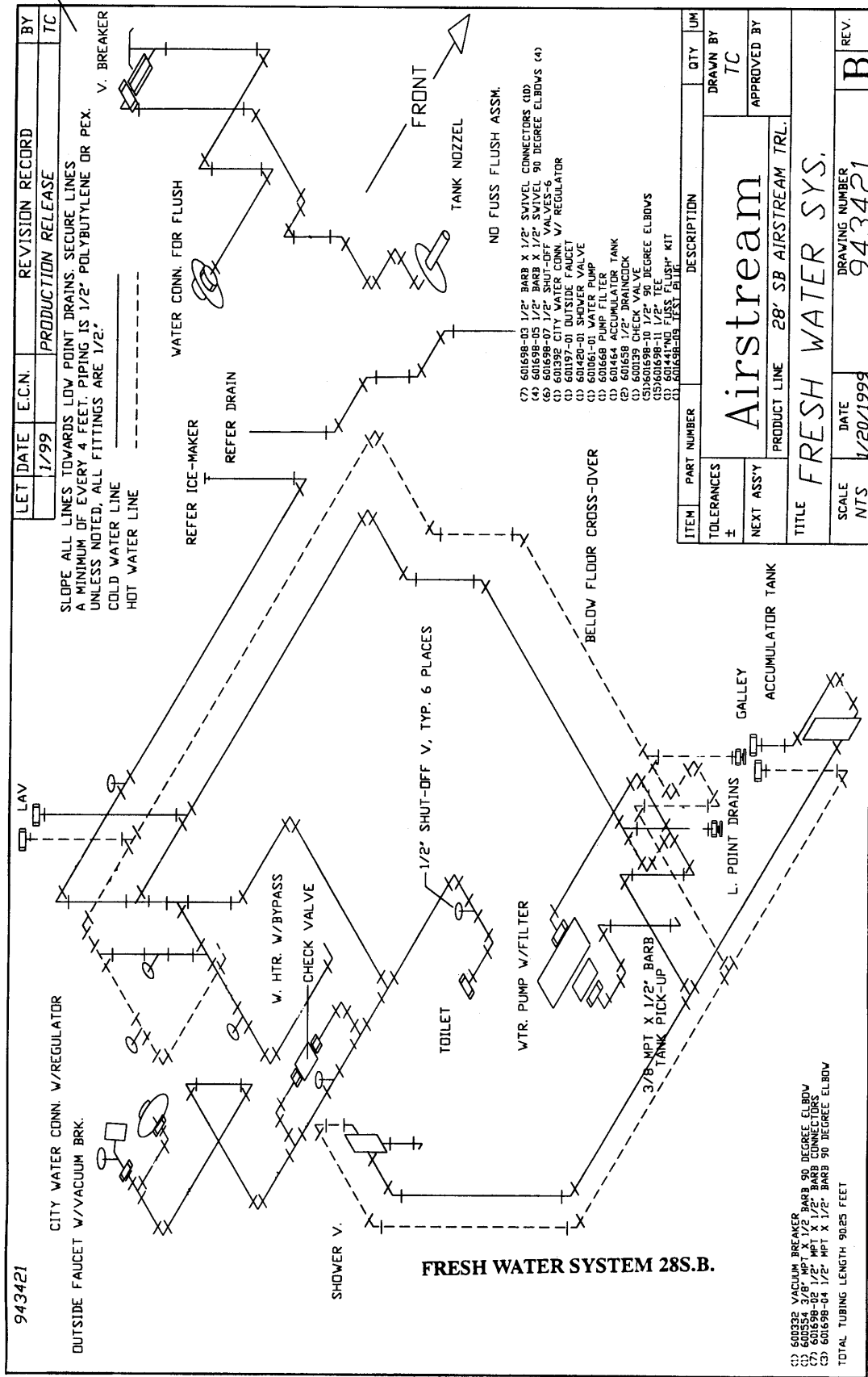

AIRSTREAM CLASSIC TRAILER OWNERS MANUAL

FRESH WATER SYSTEM 30S.B.

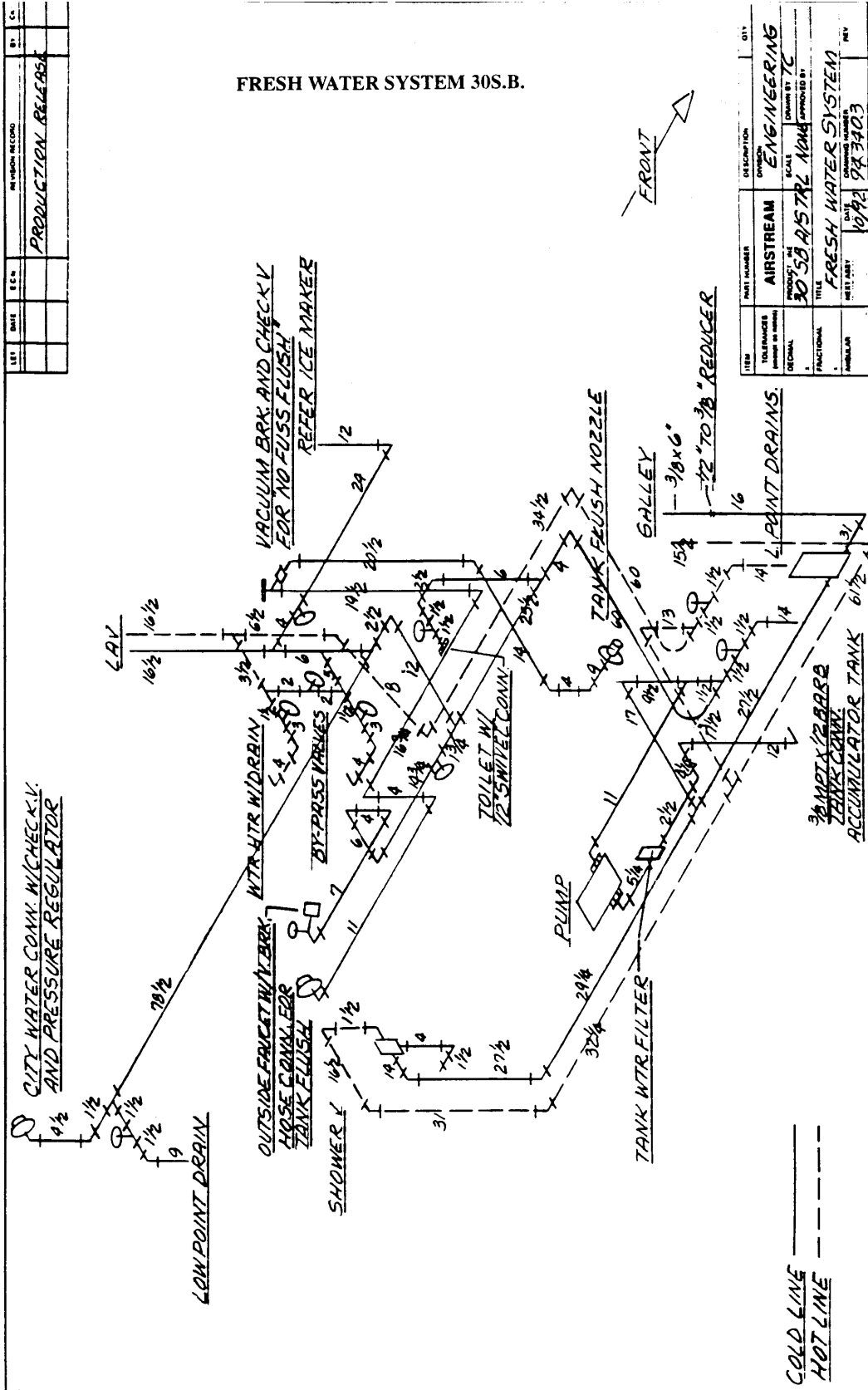

REV	DATE	BY	DESCRIPTION
1			PRODUCTION RELEASE

ITEM	DESCRIPTION	QTY
1	AIRSTREAM ENGINEERING	
2	30 GAL WATER TANK	
3	FRESH WATER SYSTEM	
4	ACCUMULATOR TANK	

AIRSTREAM CLASSIC TRAILER OWNERS MANUAL

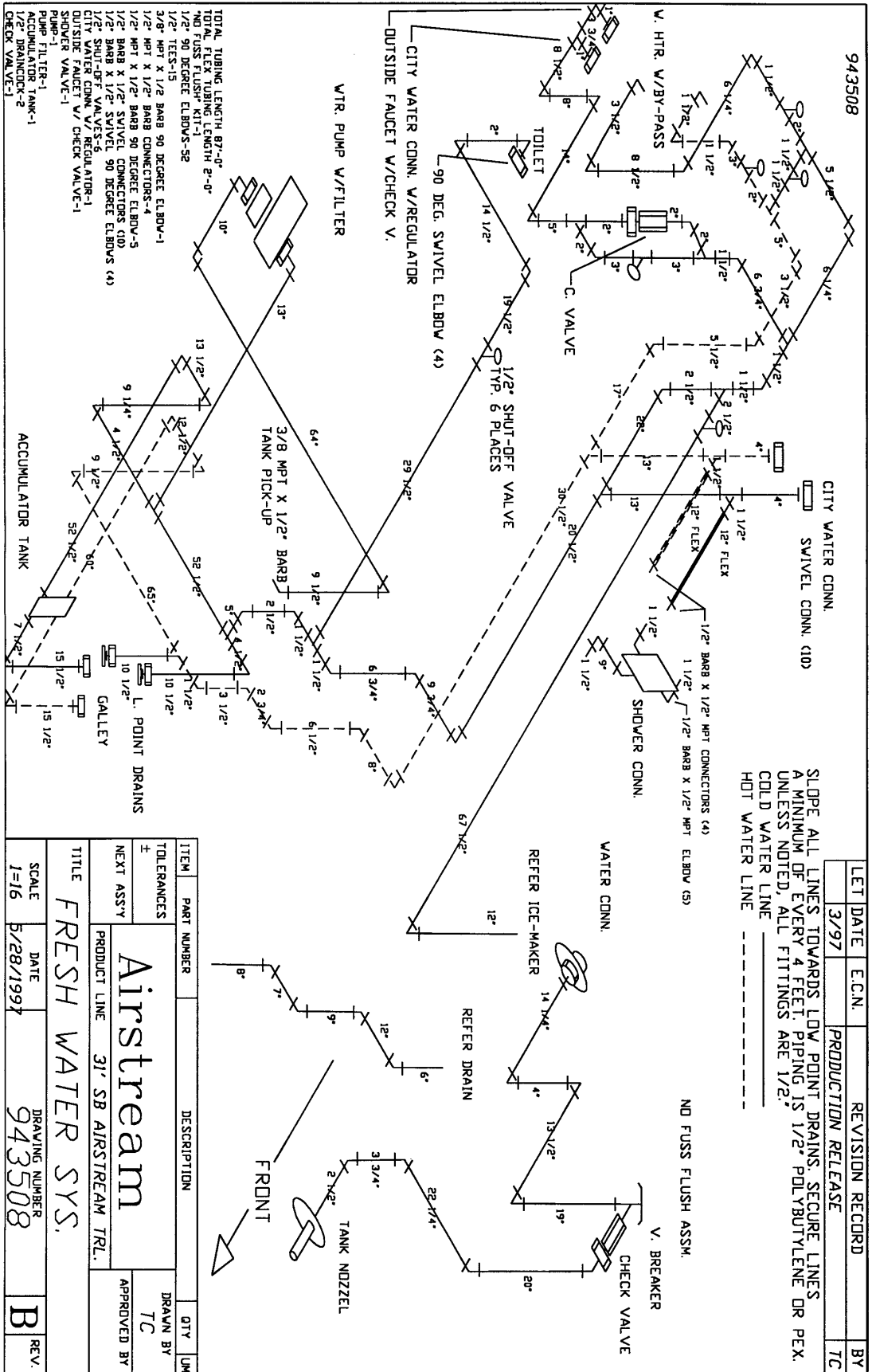

AIRSTREAM CLASSIC TRAILER OWNERS MANUAL

FRESH WATER SYSTEM 34 S.B.

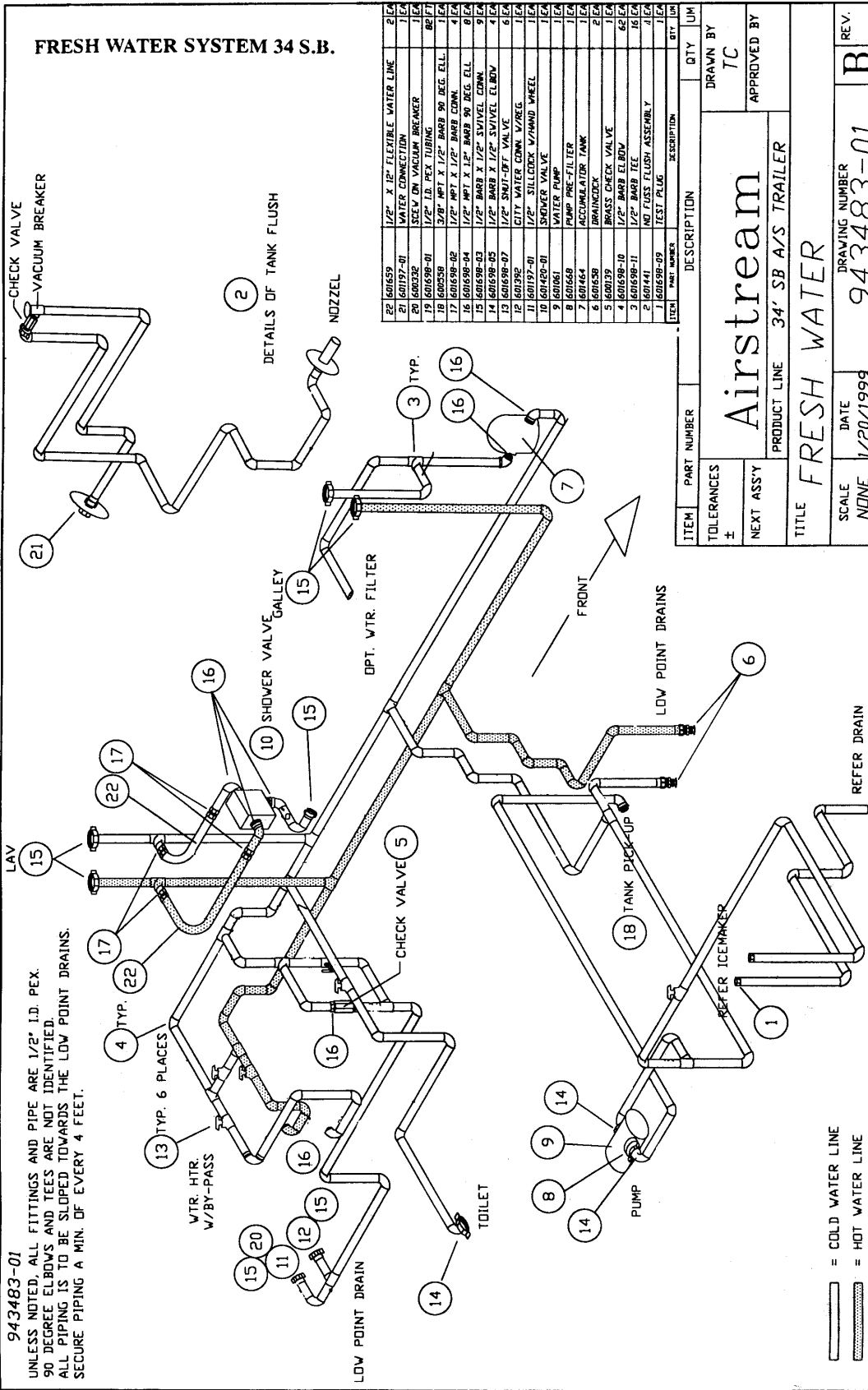

AIRSTREAM CLASSIC TRAILER OWNERS MANUAL

DRAIN AND WASTE SYSTEM

Your trailer has a drain and waste system that includes waste-holding tanks made from molded plastic, free from corrosion problems, with trouble-free dump valves.

The MAIN HOLDING TANK enables you to use the toilet for several days away from disposal facilities. The wastewater from the sink, shower, bath and lavatory drains in the AUXILIARY HOLDING TANK. Each tank has its own dump valve, however, both tanks drain through a common outlet. Therefore, you need to make only one connection when hooking up in a trailer park with sewer facilities.

CAUTION: Never put wet strength paper towels or tissues in your holding tank since they won't dissolve and can "catch" in the mechanism of the dump valve. Colored toilet tissue is slower to dissolve than white. Most RV accessory stores offer tissue designed for RVs that will completely dissolve.

Deodorizers

There are many deodorizers on the market in tablet, liquid and powder form. These not only combat odor, but also stimulate the bacteria that works to dissolve the solids in your tank.

Monitor Panel

Check your monitor panel frequently. When the BLACK WATER HOLDING TANK is completely full, sewage cannot be emptied from the toilet bowl. If the GRAY WATER HOLDING TANK is overfilled, drain water will "backup" into the tub and cause an unpleasant cleaning job. Never drain the tanks at any place other than an approved dumping station.

Emptying Tanks

Almost all campgrounds will have dumping facilities. Park directories such as Woodalls and Rand McNally also list dumping stations.

To empty one or both tanks attach the sewer hose by pressing the bayonet fitting onto the dump valve outlet and rotate clockwise until it feels solid and secure. Attach the outlet end of the hose to the sewage outlet; making sure that the hose is placed so it will drain completely.

Pull the dump valve handle as far as it will go and wait until the tank is drained. When dumping, the main holding tank should be dumped first; then the auxiliary holding tank. This will help to rinse out the sewer line with auxiliary holding tank water.

The main holding tank must be flushed out until all paper and waste material is removed. Close the dump valve and refill the tank with clean water and repeat until clean. Replace the cap prior to traveling.

AIRSTREAM CLASSIC TRAILER OWNERS MANUAL

Black Tank Flush

Inside the utility compartment is a water hose connector for the "black tank flush". To use, hook up a hose and turn on full force. Within the tank a head with multiple holes will spray the interior surface of the tank. The vacuum breaker and check valve will be located inside the trailer above the exterior connection. In most models this will place them under the lavatory.

The gate valve should be closed for the first couple of minutes, and then opened to let the water out in a rush. Repeat as needed.

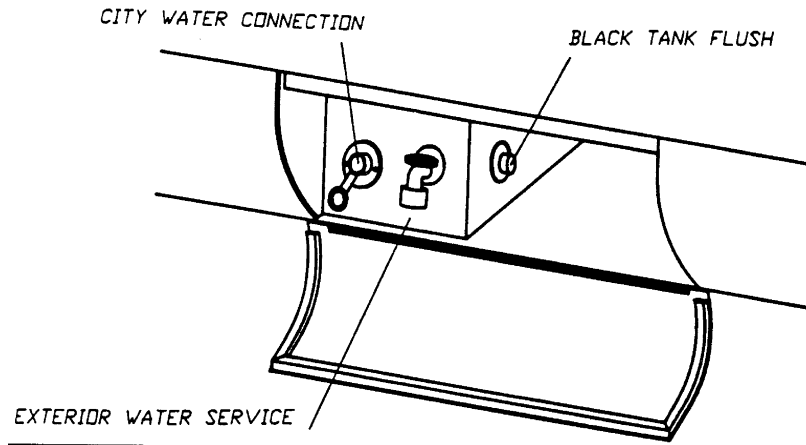

When Parked and Connected to Sewer Outlet

When you are in a park and connected to a sewer outlet keep the main holding tank dump valve closed, and empty the tank every few days or whenever it becomes almost full. **ONLY BY SENDING A LARGE VOLUME OF LIQUID THROUGH THE MAIN HOLDING TANK AT A TIME WILL TOILET PAPER AND OTHER SOLIDS COMPLETELY WASH AWAY.**

This practice will avoid the accumulation of solids in the main holding tank, which could lead to an unpleasant cleaning job. Should solids accumulate, close the dump valve; fill the tank about half full with water, then tow the trailer for a few miles. The turbulence and surging of the water will usually dissolve the solids into suspension so the tank can be drained. Keep the auxiliary tank valve open when connected to a sewer outlet.

Draining the tanks as described will protect them from freezing during storage. When traveling in sub-freezing temperatures use a winterizing solution designed for RV use. Follow the directions on the container.

Drain Systems Cleaning

The only cleaning agents that can be used without causing harm to the system are household ammonia and tri-sodium phosphate in small quantities. Do not use any product that contains any portion of petroleum distillates. This attacks the rubber seats of your toilet and dump valve. Also, do not use any dish detergent or abrasive cleaners. All products should be marked approved for ABS drainage systems.

When winterizing drains use only trailer plumbing system type antifreeze. These are sold through your dealer.

AIRSTREAM CLASSIC TRAILER OWNERS MANUAL

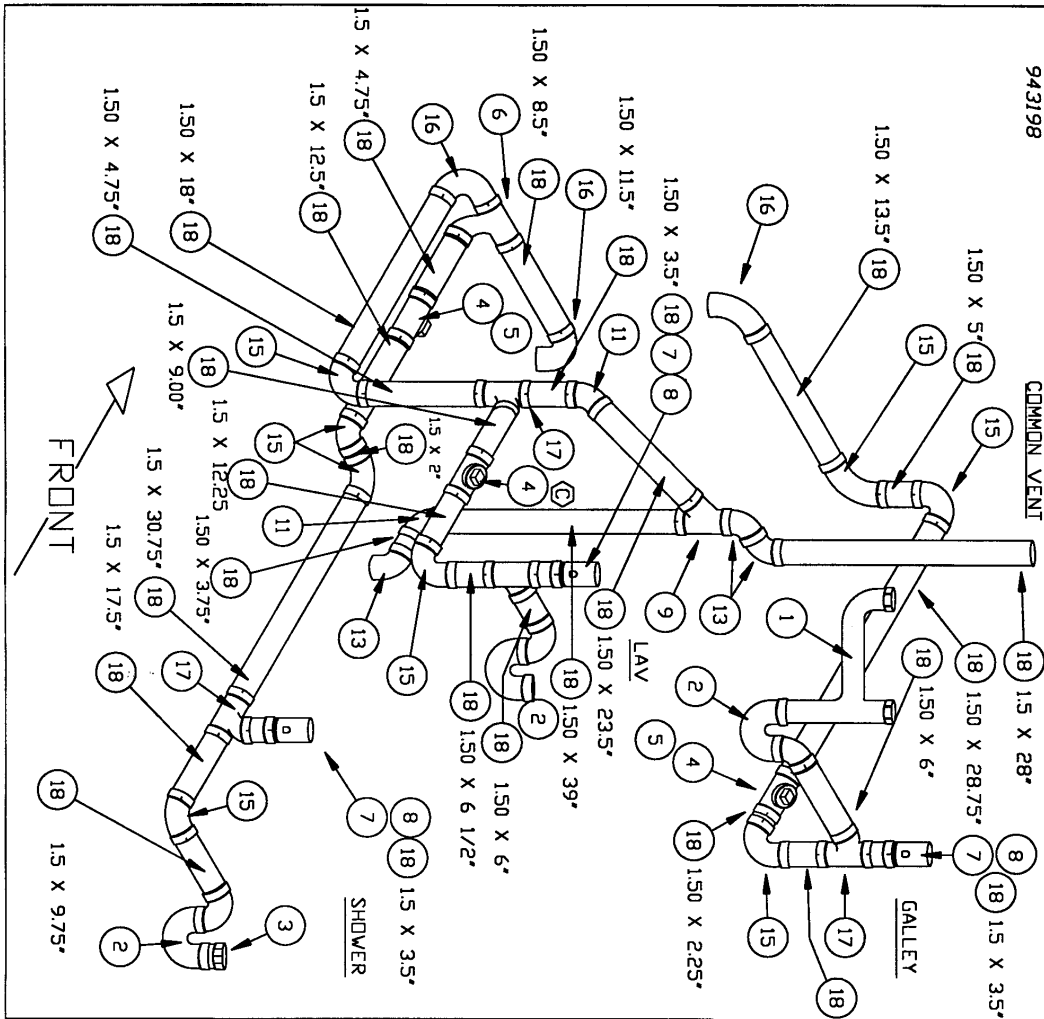

943198

LET DATE		EC.N.	REVISION RECORD	BY
A	5/94	4465	PRODUCTION RELEASE	TC
B	3/96	4744	REVISE LAV DRAIN & ADJ. SIZES	TC
C	2/99	4744	REDRAW & REVISE LAV LINE	TC
	10/99	4804	ADDED 1.50" CLEANOUT	DW

NOTES:
 SLOPE DRAIN LINES A MIN. OF 1/8" PER FOOT.
 SLOPE TRAP ARMS 1/4" PER FOOT.
 COMMON VENT CONN. ABOVE THE FLOOD LEVEL OF THE HIGHEST FIXTURE.
 SECURE LINES EVERY 4' WITH RUBBER LINED CLAMPS
 PART NUMBER 340085-11.

18	60160-02	PIPE, ABS DVM, 1-1/2"	27.0 FT
17	600156	1.5" SANITARY TEE	3 EA
16	600431	ST. ELBOW, 90 XL T, 1-1/2 IN	3 EA
15	600035	ELBOW, 90 XL T, 1.50"	8 EA
14			
13	600027	ST. ELBOW, 45 DEGREE, 1.50"	2 EA
12			
11	600030	ELBOW, 45 DEGREE, 1.50"	1 EA
10	601203	ST. ELBOW, 45 DEGREE, 1.25"	2 EA
9	600094	1.50" 45 DEGREE WYE #2301	1 EA
8	600308	ADAPTER ABS FEMALE, 1.50"	2 EA
7	600538	1.50" VENT V-200 AUTOMATIC	2 EA
6	600182	LTTY, 1-1/2"	1 EA
5	600155	PLUG, CLEANOUT 1-1/2	2 EA
4	601318	TEE, BI-DIRECTIONAL CLEANOUT 1 1/2	3 EA
3	601201	SWIVEL STRAINER ADAPTER TUB DRAIN	1 EA
2	600144	P TRAP ABS 1-1/2 IN	2 EA
1	600378	CONTINUOUS WASTE 1-1/2	1 EA

ITEM	PART NUMBER	DESCRIPTION	QTY	UM
TOLERANCES				
F	Airstream			DRAWN BY
NEXT ASSY	PRODUCT LINE 25' SB A/S TRL.			TC
APPROVED BY				

TITLE **ABOVE FLOOR DWV**

SCALE 3:32 DATE 05/09/94 DRAWING NUMBER 943198 REV. B C

AIRSTREAM CLASSIC TRAILER OWNERS MANUAL

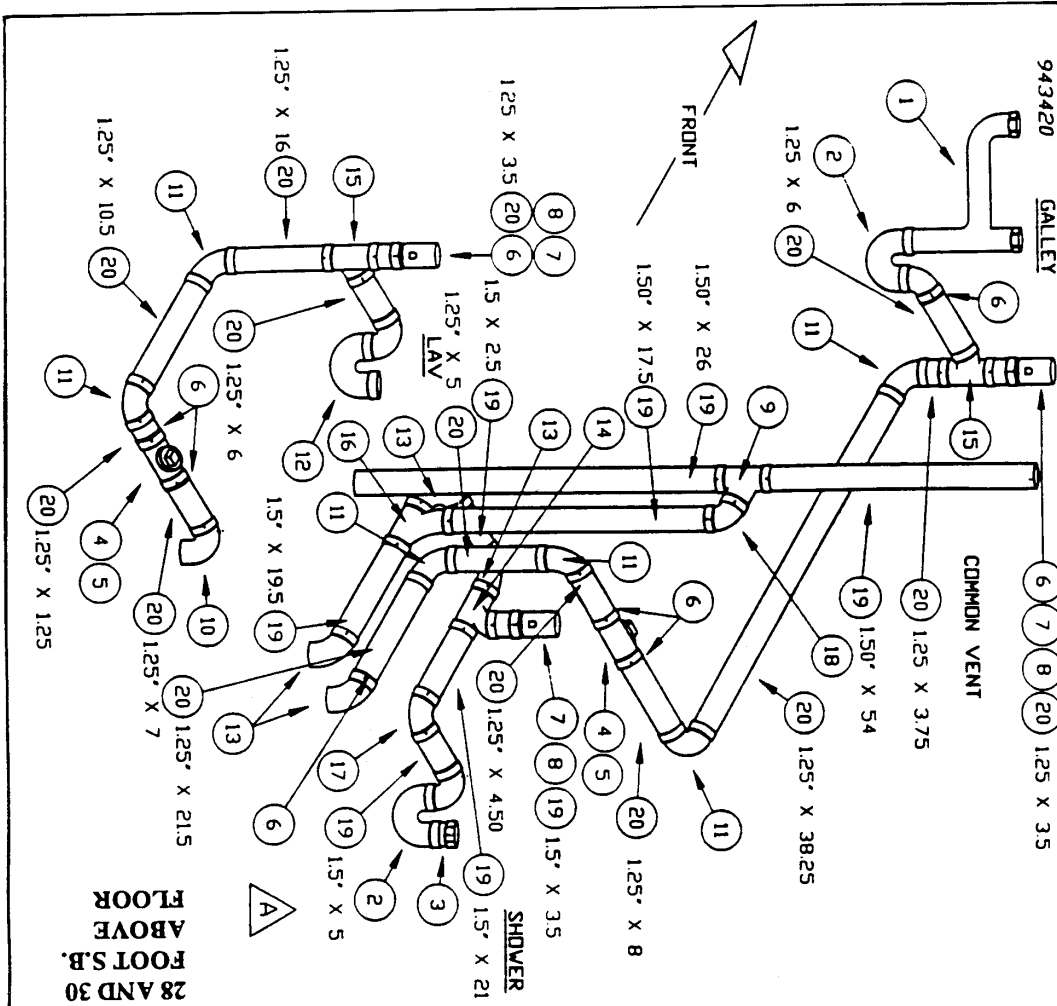

LET	DATE	E.C.N.	REVISION RECORD	BY
7/88	4164		PRODUCTION RELEASE	JM
A	2/95		ADD 3RD GREY TANK ENTRY	TC

ITEM	PART NUMBER	DESCRIPTION	QTY	U/M
20	601160-01	PIPE, ABS D.V.V., 1.25"	11/2	FT
19	601160-02	PIPE, ABS D.V.V., 1-1/2"	12/4	FT
18	600027	1.50" 45 DEGREE ST. ELL	1	EA
17	600030	1.50" 45 DEGREE ELL	1	EA
16	600182	1.50" LTTY	1	EA
15	601198	1.25" SANITARY TEE	2	EA
14	600156	1.50" TEE SANITARY	1	EA
13	600431	1.50" 90 DEGREE, XLT ST. ELL	4	EA
12	601202	P-TRAP W/UNION, 1.25" #62615	1	EA
11	601199	1.25" 90 DEGREE, XLT ELL	6	EA
10	601440	1.25" 90 DEGREE, XLT ST. ELL	1	EA
9	600094	1.50" 45 DEGREE WYE	1	EA
8	600308	ADAPTER ABS FEMALE SLIDAN #2891	3	EA
7	600538	VENT V-200 AUTOMATIC	3	EA
6	601263	BUSHING 1.5 X 1.25 ABS	8	EA
5	600155	PLUG, CLEANOUT 1-1/2	2	EA
4	601318	TEE BI-DIRECTIONAL CLEANOUT 1 1/2	2	EA
3	600442	SWIVEL STRAINER ADAPTER TUB DRAIN	1	EA
2	600144	P TRAP ABS 1-1/2 IN	2	EA
1	600378	CONTINUOUS WASTE 1-1/2	1	EA

TOLERANCES
 ±
 NEXT ASSY
Airstream
 PRODUCT LINE 28' & 30' SB A/S TRL 3
 DRAWN BY TC
 APPROVED BY
ABOVE FLOOR DWV
 TITLE
 SCALE 3:32 DATE 05/14/94 DRAWING NUMBER 943420 REV B A

AIRSTREAM CLASSIC TRAILER OWNERS MANUAL

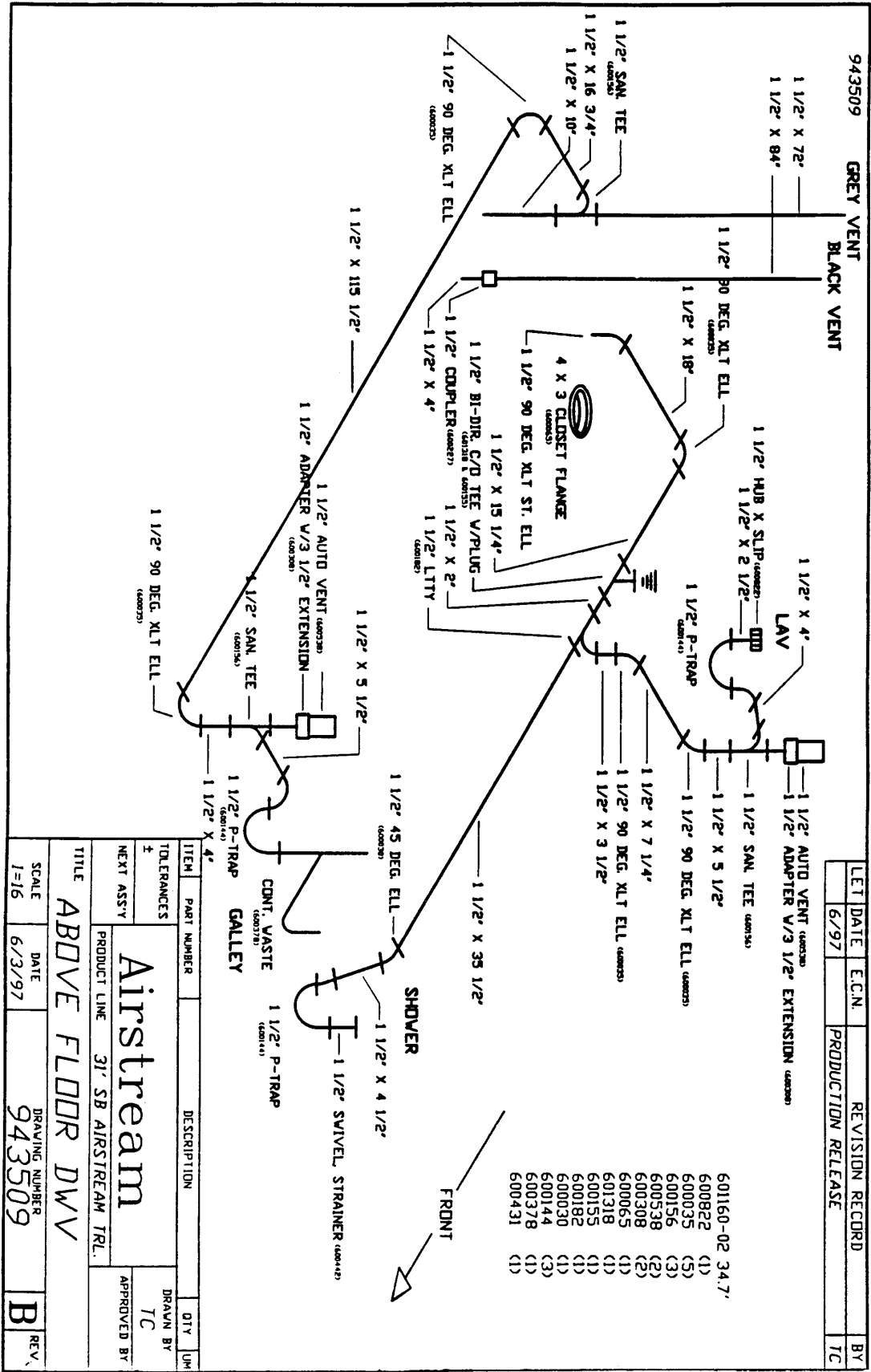

AIRSTREAM CLASSIC TRAILER OWNERS MANUAL

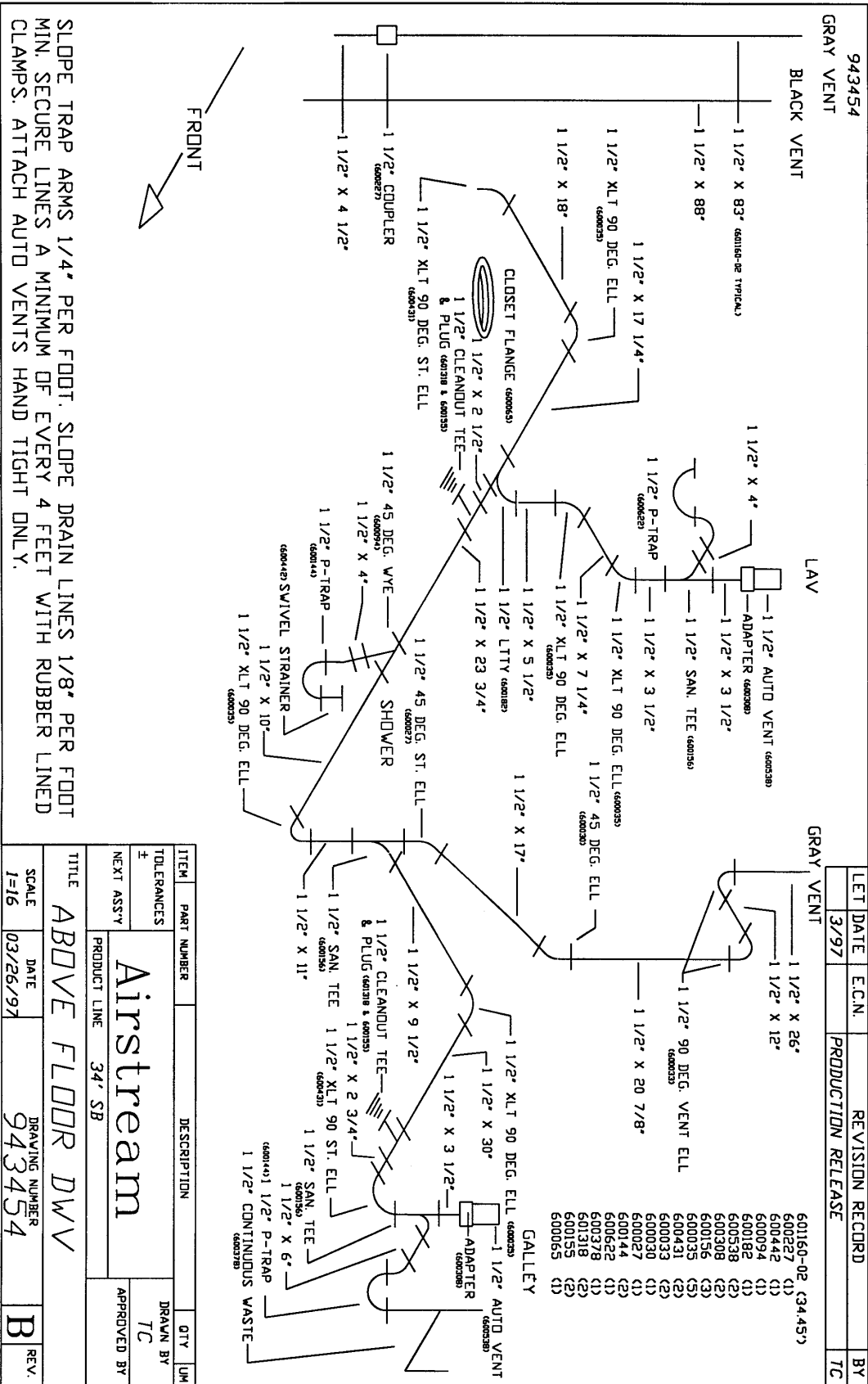

943454	GRAY VENT	LET DATE	EC.N.	REVISION RECORD	BY
		3/97		PRODUCTION RELEASE	TC

- 601150-02 (34.45")
- 600227 (1)
- 600142 (1)
- 600094 (1)
- 600182 (1)
- 600538 (2)
- 600308 (2)
- 600156 (3)
- 600035 (3)
- 600431 (2)
- 600033 (2)
- 600030 (1)
- 600027 (1)
- 600144 (2)
- 600522 (1)
- 600378 (1)
- 601318 (2)
- 600155 (2)
- 600065 (1)

ITEM	PART NUMBER	DESCRIPTION	QTY	DM
TOLERANCES				DRAWN BY
F				TC
NEXT ASSY				APPROVED BY
TITLE		Airstream		
ABOVE FLOOR DWV		PRODUCT LINE 34' SB		
SCALE	DATE	DRAWING NUMBER		
1=16	03/26/97	943454		
				REV. B

AIRSTREAM CLASSIC TRAILER OWNERS MANUAL

REVISED RECORD	BY	DATE	DESCRIPTION
		7/81	PRODUCTION RELEASE TO

25, 28, 30 AND 31 FOOT
S.B. BELOW FLOOR

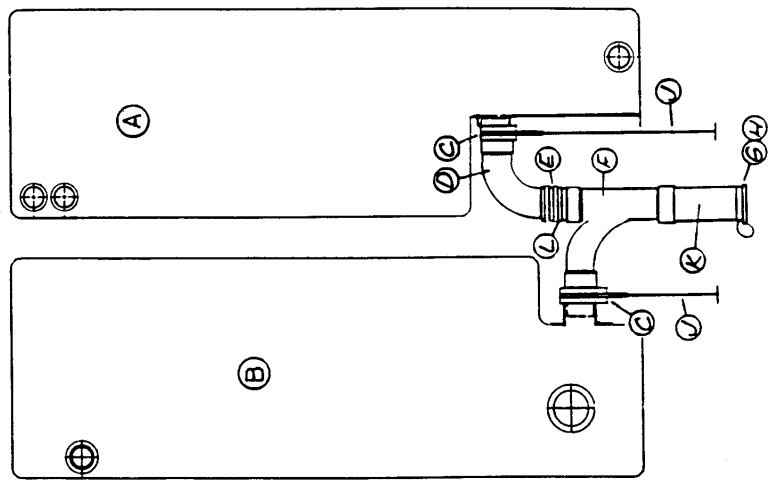

FRONT

PLAN VIEW

ITEM	PART NUMBER	DESCRIPTION	QTY
L	601160203	3" DIA X 3"	1
K	601160204	3" DIA X 10" ABS	1
V	600214	EXTENSION HANDLE	2
H	601251	BAYONET RING	1
S	601250	BAYONET CAP	1
F	600187	3" WYE	1
E	600289	RUBBER UNION	1
D	600820	3" 90° XLT ST ELL	1
C	600405	DUMP VALVE	2
B	NOTE 2	BLACK TANK	1
A	NOTE 1	GRAY TANK	1

AIRSTREAM		SCALE	DRAWN BY
PRODUCT LINE		NONE	
25, 28, 30, 31 FT. TRAILERS		APPROVED BY	
FUNCTIONAL		DATE	
ASSEMBLER		DATE	
BELOW FLOOR DRAINAGE		943178	

AIRSTREAM CLASSIC TRAILER OWNERS MANUAL

943547

FRONT

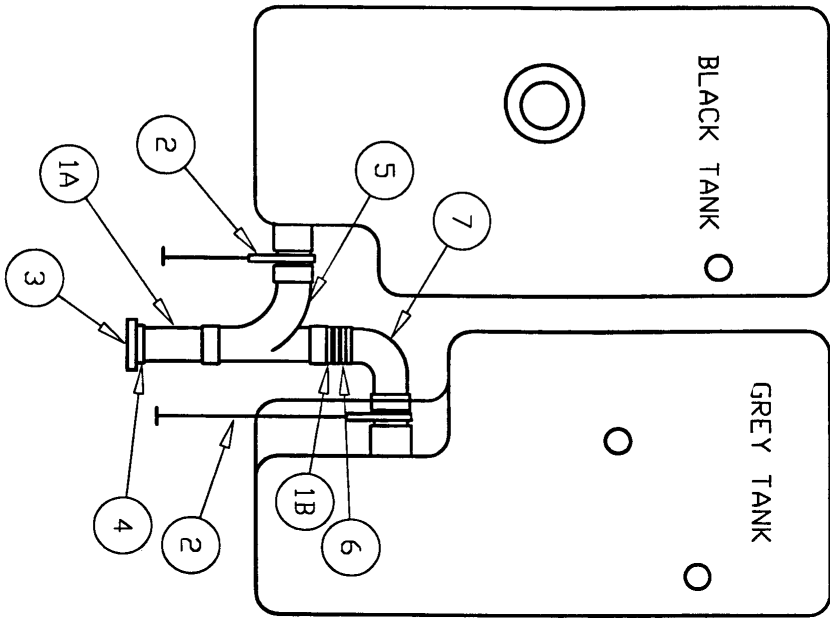

SLOPE DRAINS A MINIMUM OF 1/8" PER FOOT.
CLAMP ASSEMBLY TO PREVENT VIBRATION.

LET DATE	EC.N.	REVISION RECORD	BY
6/99	4767	PRODUCTION RELEASE	DW

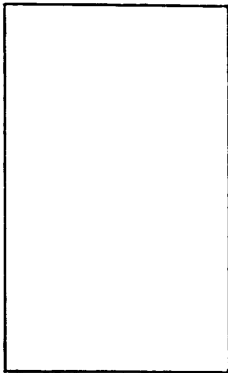

7	600820	3" SINGLE SOCKET 90DEGREE	1EA
6	600289	CALDER COUPLING 3IN (RUBBER)	1EA
5	600187	3" WYE, COMB & 1/8 BEND	1EA
4	601251	ADAPTOR 3" TERMINATION	1EA
3	601250	CAP, 3" BAYONET W/8" PLASTIC STRP	1EA
2	601431	DUMP VALVE W/O HANDLE #08709	2EA
1A		3.00 LENGTH	1EA
1B		10.00 LENGTH	1EA
1	60160-04	PIPE, ABS D.V.V., 3"	11 FT
ITEM	PART NUMBER	DESCRIPTION	QTY
TOLERANCES			DRAWN BY
±			DW
NEXT ASSY			APPROVED BY
FIRST USAGE:		34' S/O TRL.	
Airstream			
TITLE BELOW FLOOR DRAINAGE			
SCALE	DATE	DRAWING NUMBER	REV.
1=1	04/28/98	943547	A

AIRSTREAM CLASSIC TRAILER OWNERS MANUAL

TOILET

Manufacturer: Thetford Corporation
7101 Jackson Road
Ann Arbor, MI 48103
313-769-6000

Sealand Technology (34' Classic non-slide only)
13128 State Route 226, P.O. Box38
Big Prairie, Oh. 44611
1-800-321-9866

The RV toilet in your Airstream is a design that has been used for many years. There are two pedals. The large pedal opens and closes the slide mechanism, and the smaller pedal opens and closes a water valve.

In normal use, when you are hooked up to city water, both pedals are depressed together. This dumps the sewage and fresh water and flushes down the side of the bowl. Water will continue to run into the bowl for a short time after the pedals are released.

When you wish to conserve water hold the hand-spray head over the bowl and hold down the thumb-operated lever. Now when you depress the pedal all the water is routed through the hand-spray.

CAUTION: When you dump the bowl of the toilet make sure all paper and solids have cleared the slide mechanism before you allow it to close. Failure to do so can cause the groove for the slide to become jammed and the slide will no longer close completely.

If the problem should occur a small nail or bent clothes hanger can be used to "pick" the material out of the groove.

AIRSTREAM CLASSIC TRAILER OWNERS MANUAL

ELECTRICAL

OPERATION

The major portion of electrical power in your Airstream is 12-volt. The 12-volt current powers the fans, furnaces, water pump, and water heater ignition. The exception would be the air conditioner and microwave oven.

All 12-volt current comes through the battery system in the front of your trailer. The battery or batteries are accessible from the exterior on the front of your trailer. Power from the battery first goes to a master or "kill" switch inside the trailer. The kill switch, 12-volt distribution panel, and converter are located under the front sofa. Open the lounge door under the sofa seat and look on the roadside of the storage area. The kill switch and distribution panel are mounted on a hinged panel that lowers to access the converter. On trailers without a front sofa the 12-volt distribution panel and the kill switch is located under the computer table. The master switch should be left in the ON position except when storing, or a mechanic may use the switch when servicing the trailer.

Power from the main switch continues on to the 12-volt distribution panel, and then to the rest of the trailer. The 12-volt distribution panel has reset circuit breakers and does not require routine servicing. If a short should occur the breaker in that circuit will "click" off and you may notice some lights or appliances losing power. If this should happen, immediately turn the lights and appliances off that are on the shorting circuit and reset the breaker by depressing the small button in the end. If the breaker continues to "click" turn the main power off until a qualified technician can service your trailer.

The charge in the 12-volt batteries is replenished when towing or when plugged into 110-volt city power.

AIRSTREAM CLASSIC TRAILER OWNERS MANUAL

BATTERY

CAUTION: A normal battery can discharge by itself in 30 to 40 days when not in use, therefore, IT IS NECESSARY TO PERIODICALLY CHECK THE BATTERY AND CHARGE IT AS IS NECESSARY.

We suggest checking the battery at least every two weeks in freezing weather. The temperature at which a battery will freeze depends on the condition of its charge. As an example: a fully charged battery with a specific gravity of 1.265 will not freeze until the electrolyte temperature drops to - 71.3 degrees F, while a discharged battery will freeze at +19 degrees F. The following table shows the freezing points of batteries at various specific gravity readings, temperature corrected 80 degrees F.

1.265	-71.3 F
1.250	-62 F
1.200	-16 F
1.100	+5 F
1.150	+19 F

Do not add water to a battery in freezing temperatures unless the vehicle will be put to use at once, otherwise the added water may freeze. Neglect is expensive. Care costs little. Check your batteries regularly.

MAINTAIN A CLEAN BATTERY TOP AND CHECK TERMINALS AND CABLES FOR TIGHTNESS AND CLEANLINESS. A dirty battery will dissipate its charge through surface contamination. Clean battery top with a damp cloth and dry thoroughly.

The terminals should be tight and free of corrosion. To clean terminals, neutralize with a solution of baking soda, rinse in clear water, and dry.

Note: Care must be used to make sure soda is not allowed to enter battery cells.

To insure maximum battery capacity on the charge and the discharge, the battery terminals and the inside portion of the cable connector should be scraped or brushed until both of these surfaces are shiny bright. The cable connectors should then be reconnected to the battery and tightened. The complete assembly, battery post and cable connector should be coated with heavy body mineral grease, petroleum grease or petroleum jell.

CAUTION: RECONNECT THE BATTERY CABLES TO THE CORRECT BATTERY POSTS. The black cable should be connected to the negative (-) post and the red cable to the (+) post. The polarity of your tow vehicle must also be negative (-) ground since it must always match the trailer. Most tow vehicles are negative grounded, but always check your vehicle owner's manual to be sure.

ADD WATER TO CELLS AS NECESSARY. Check the electrolyte level at least once a month. When you are traveling steadily and for an extended period of time, or if you are in climates above 90 degrees F, check the electrolyte level about every two weeks.

CAUTION: Do not fill battery above the split ring in filler opening. DO NOT MEASURE SPECIFIC GRAVITY IMMEDIATELY after adding water. The water must mix with the electrolyte by charging or by driving a few miles.

AIRSTREAM CLASSIC TRAILER OWNERS MANUAL



WARNING: The gases generated within a storage battery cell may be ignited by an open flame or spark in the vicinity of the battery. Do not use a match or flame to provide light for checking the level of the water.

During the winter the battery should be removed from the trailer and stored in a cool, dry place, where there is no danger of freezing. It should be kept full of water, cleaned and charged monthly. A battery that is allowed to completely lose its charge will never regain its original power or a full charge.

Slide the battery out onto the opened compartment door for service and removal

For battery service or replacement, go to any service station or dealer who sells and services the make battery installed in your trailer.

When being towed, the 12-volt battery in your trailer is receiving a constant charge from the car's generator or alternator through the seven-way connector.

Your tow vehicle's voltage regulator controls the charge rate. It is important to keep the seven-way connector clean. One method is to use "Spra-Kleen".

Whenever possible use the automatic built in charge of the converter system for charging. The charging circuit automatically controls the current, reducing it as the battery increases in charge.

At service stations make certain they give your battery a slow charge because quick charges will drastically shorten the life of the battery, as will allowing repeated complete discharges.

CONVERTER

The converter system is the interior low voltage electrical system that enables you to use the interior lights, fans, pumps and 12-volt appliances whether operating on self-contained battery power or 120-volt city power.

CAUTION: Plugging the trailer into 120 volt city power with the master switch off will blow radio fuses and may damage other 12-volt components. Use the master switch when storing the vehicle for long periods of time.

12V POWER CIRCUITS

The current in the converter system is 12 volts direct current (12VDC) negative grounded.

Power sources that supply 12VDC current to the system are as follows:

- A. Main charge line from tow vehicle
- B. Trailer Battery
- C. Converter

The power sources above are all electrically connected to the 12-volt distribution fuse panel that distributes current to interior branch circuits. The circuits provide power to operate all 12-volt DC lights, pumps, motors and appliances.

AIRSTREAM CLASSIC TRAILER OWNERS MANUAL

Converter

The converter transforms 120-volt alternating current (AC) into 12-volt direct current (DC). This provides power to charge the trailer battery and to operate the 12 volt interior lighting, fans, and appliances.

The converter is energized only when the trailer is hooked up to 120-volt city power.

Converter Testing

- A. Confirm 120 volt power is going into converter.
- B. Disconnect the 12+ wire from the master switch.
- C. Using a voltmeter check voltage output between heavy positive and negative wires coming out of converter.
- D. The voltage must be within 13.8 and 14.0 volts. (The meter of the tester should be calibrated periodically.)
- E. If converter is not within these voltages, replace it.

Converter Removal

1. Disconnect power cord for 120-volt supply.
2. Switch circuit breakers to off position.
3. Remove the front lounge.
4. Disconnect lead-in wires running from converter assembly to 12 -volt fuse distribution panel.
5. Remove converter box.
6. Remove four screws mounting the converter assembly to the floor.
7. Remove the converter assembly.
8. To install, reverse the removal procedures.

AIRSTREAM CLASSIC TRAILER OWNERS MANUAL

12-VOLT EXTERIOR

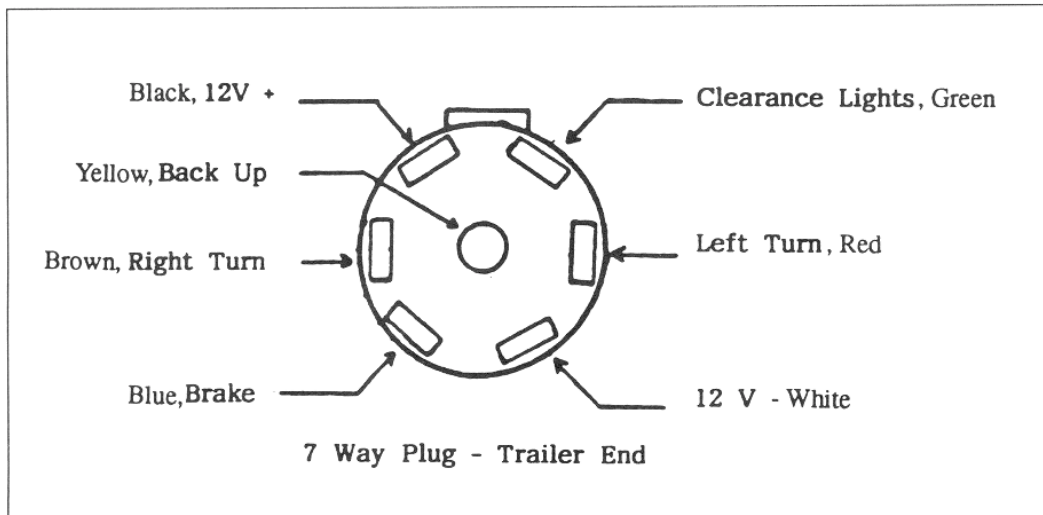
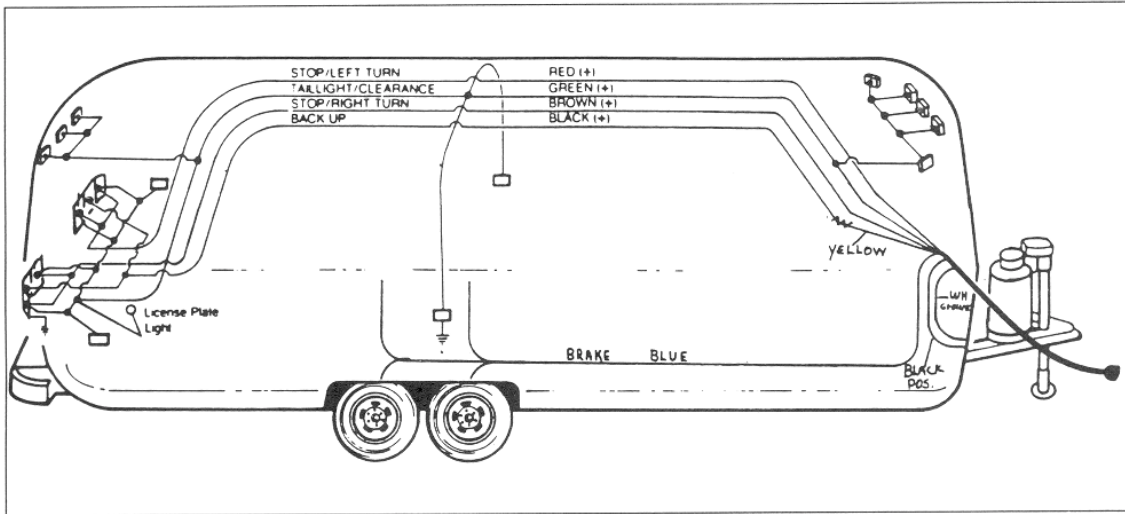

Note: The 7 way wire is spliced to the main harness behind the front sofa in the front of the trailer.

One of these wires is not spliced onto a wire of the same color. It is the back up wire that is yellow in the cable and black in the harness.

AIRSTREAM CLASSIC TRAILER OWNERS MANUAL

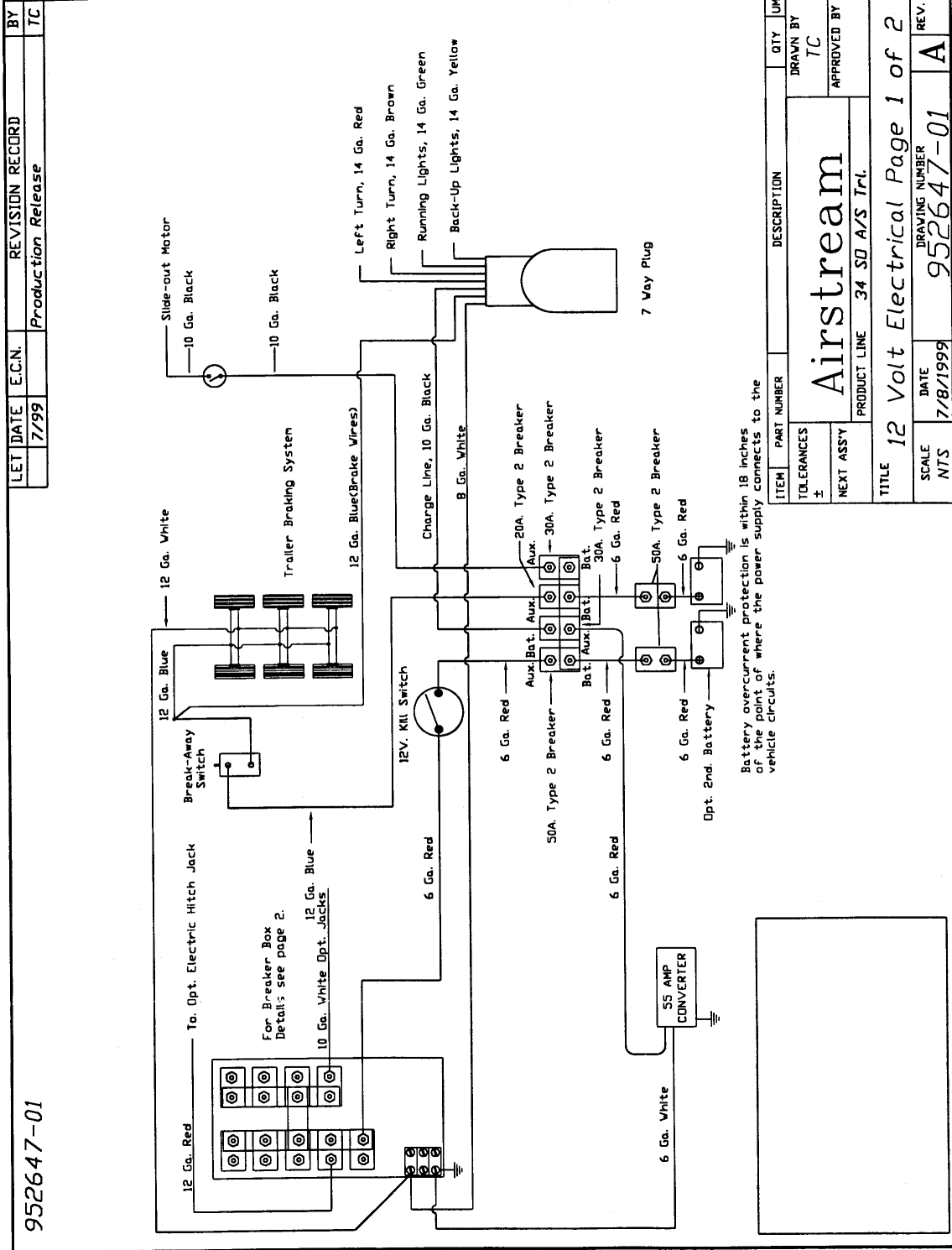

LET DATE	E.C.N.	REVISION RECORD	BY
7/99		Production Release	TC

952647-01

ITEM	PART NUMBER	DESCRIPTION	QTY	UM
TOLERANCES		Airstream	DRAWN BY TC	
NEXT ASSY			APPROVED BY	
TITLE		PRODUCT LINE	34 SD A/S Tri.	
SCALE		DATE	DRAWING NUMBER	
NTS		7/8/1999	952647-01	
			REV. A	

AIRSTREAM CLASSIC TRAILER OWNERS MANUAL

12-VOLT INTERIOR Distribution Panel, USA

The low voltage distribution panel is located under the front sofa behind the lounge door. On certain models it is under the computer desk. Manual reset breakers protect all the 12-volt circuits. If a breaker trips, an audible click will be heard, and you may have lights, appliances, or other 12-volt systems quit working. Reset the breaker by depressing the small rectangular button on the end of the breaker. If the breaker trips a second time, some of the light or appliances on that circuit should be shut off. The protruding reset button can identify the questionable breaker.

Each trailer has a master "kill switch". Access is located beside the 12-volt distribution panel. This switch should be only used when storing or servicing the trailer.

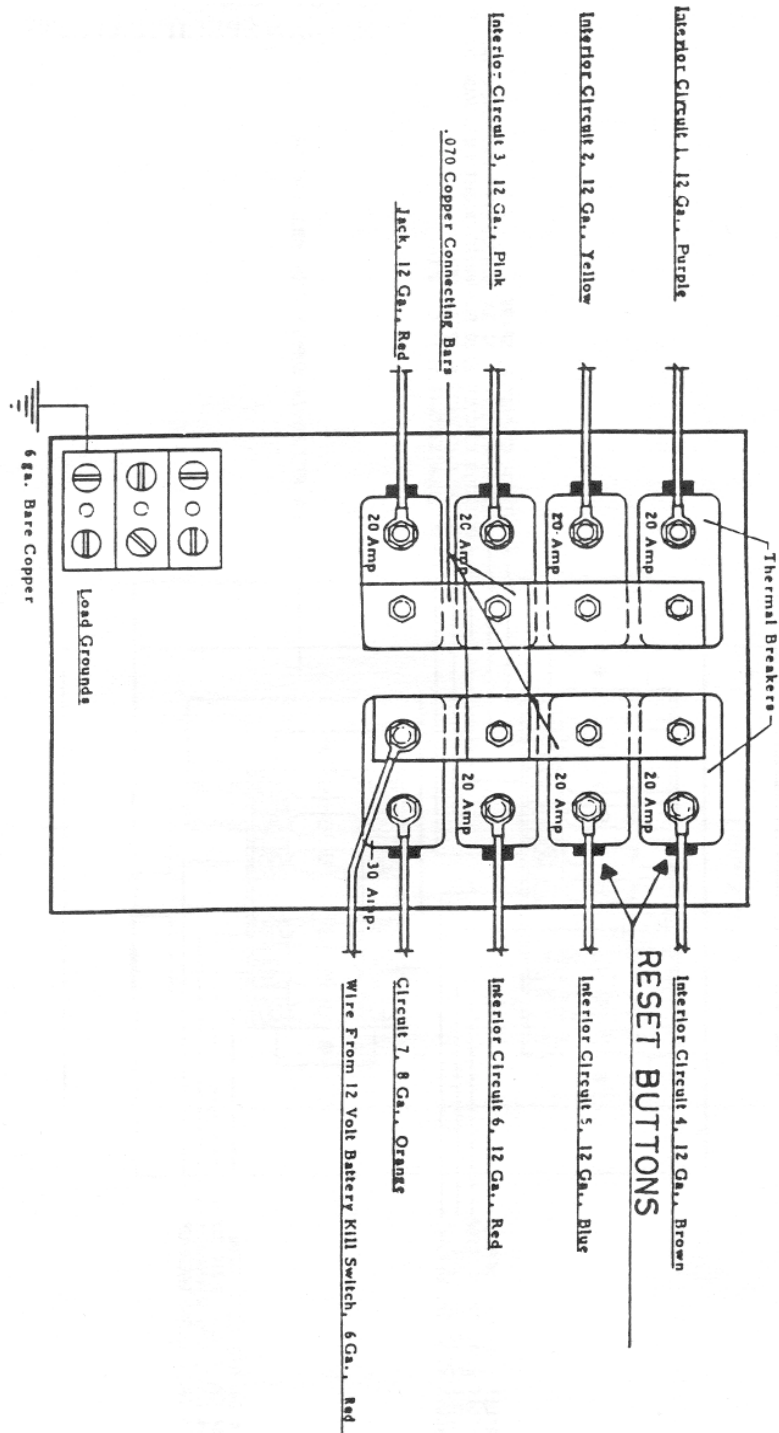

AIRSTREAM CLASSIC TRAILER OWNERS MANUAL

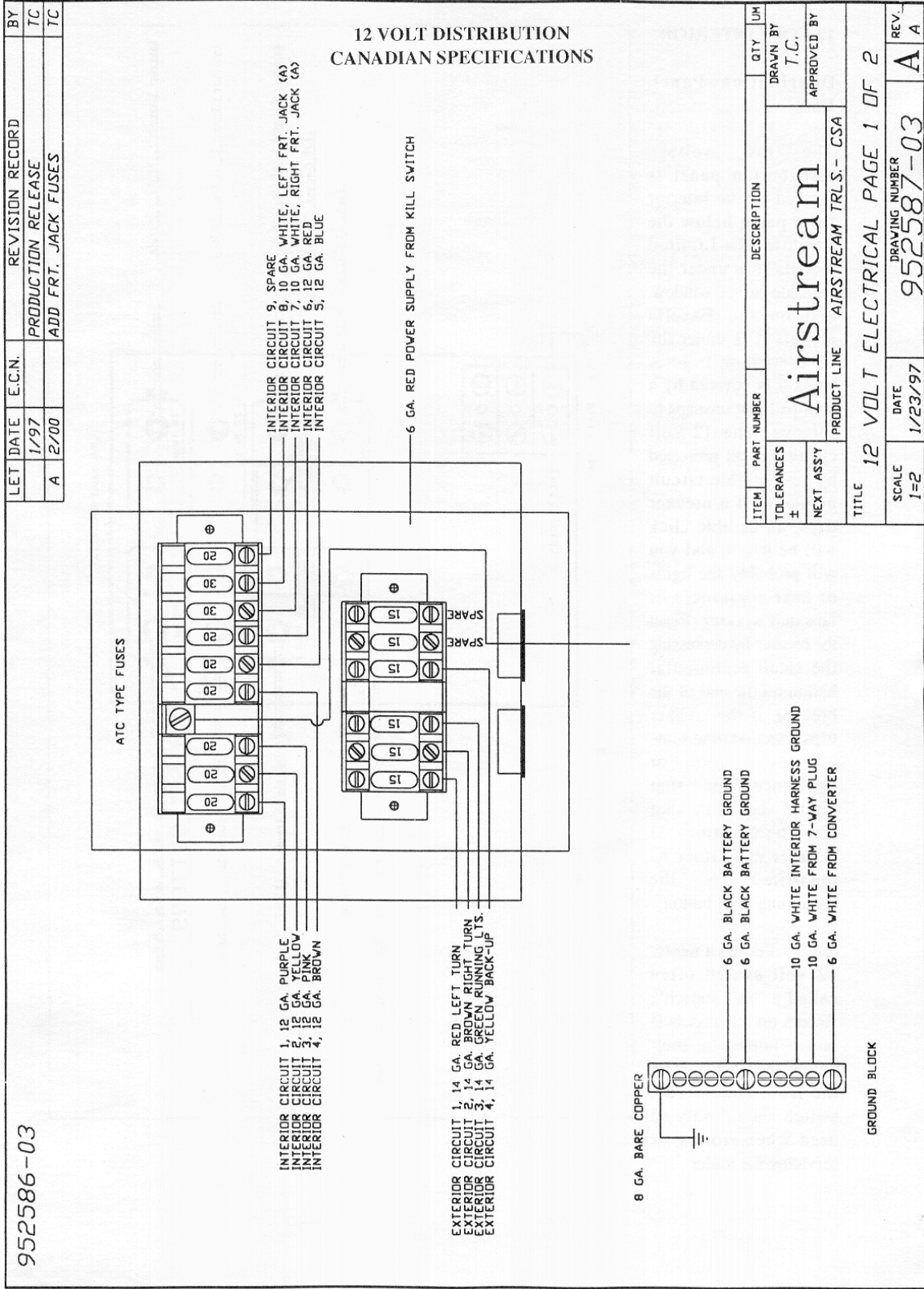

AIRSTREAM CLASSIC TRAILER OWNERS MANUAL

TROUBLE SHOOTING

The most common failure in the exterior electrical system is an open circuit. An open circuit is an interruption in the current flow, which may be in either the wire to the component or in the ground return.

Check the following areas for open circuits:

1. Light bulb (filament open.)
2. Loose or corroded connections at lighting device.
3. Loose or corroded connections at 7 way connectors
4. Improper grounding at the lighting device.

A continuity light or an ohmmeter will help you isolate the point of the "open" on the circuit. Another cause of failure is a short circuit usually resulting in a blown fuse or cycling circuit breaker at the power source. The wire coming in contact with a sharp edge usually causes a short. The sharp edge wears the wire's insulation away until the "hot" wire short to ground.

Locating Shorts and Opens

The key in locating shorts and opens is isolation. The first step is to isolate the circuit with the short or open and then isolate the section of the circuit with the fault. Once the section is identified, the specific problem can be located. The cause may be a loose or corroded connection, cut wire, worn insulation, defective component, etc. The following paragraphs describe methods of isolating shorts and opens. There are several other approaches that may be used; however, these may be used as a guide.

Shorts

1. Locate circuit that has short by noting fuse blown or cycling breaker.
2. Remove fuses or wire from breaker, and open all switches. Check for continuity between (+) 12-volt wire or shorted circuit and ground. (If it cannot be determined if the switch is in the open position, remove the lead from the switch.) Continuity to ground indicates there is a short.
3. Remove leads of shorted circuits from converter and components one at a time. After disconnecting each component, check continuity of the (+) 12-volt wire to ground. If there is no continuity the short is in the component removed. If continuity still exists, continue with the following steps.
4. Inspect leads carefully where they pass through the skin or near sharp edges.
5. Note objects attached to skin after manufacturing. The mounting screws or rivets may be causing the short.
6. Remove multi-dome to expose main body of harness. Inspect harness for cause of short, such as rivets or screws in harness or evidence of drilling.
7. If short cannot be found, cut circuit into sections, checking each section for continuity. Shorts can be isolated by this method.
8. Examples of shorts are:
 - The (+) 12-volt wire contacting (-) negative wire or grounded surface.
 - Internal short in a 12-volt component or appliance.

AIRSTREAM CLASSIC TRAILER OWNERS MANUAL

Opens

1. Check all components on circuit that has open. If all components are without power, begin to look for open on distribution panel.
2. Check for voltage on each side of the breaker. Check for tightness of crimp on connector and nut.
3. After inspecting all accessible wire on a circuit for opens, further inspection requires removal of interior skin to find the short or the installation of replacement wire. A qualified service center should be contacted for this repair.

A continuity light is a useful tool in locating an open. Each section of circuit can be checked for continuity. A process of elimination may find the open.

4. Examples of open are:

- Wire is cut.
- Connector falls off component's terminal.
- Loose or corroded connection.
- Contacts in switch do not touch

COMMON ELECTRICAL PROBLEMS

PROBLEM: No 12-volt power, (Lights and appliances do not work.)

CAUSE & REMEDY:

1. Input line and/or battery not connected. Make necessary connections.
2. Master (Kill) switch not turned on,
3. Discharged trailer battery. Charge battery.
4. Trailer battery on wrong polarity. Make proper connections to battery terminals.

PROBLEM: Tripping Breaker

CAUSE & REMEDY:

1. Overloaded circuit. Turn off switches to reduce load.
2. Electrical short. Find tripping breaker distribution panel and identify circuit. Check the circuit for defective wiring, lamps or motors.
3. Shorted battery. Replace battery.
4. Battery terminals not properly connected to converter. Make proper connections.

PROBLEM: Dim lights or sluggish fan motor.

CAUSE & REMEDY:

1. 25- or 50- cycle power (some foreign countries). Use 60-cycle power.
2. Discharged battery (when operating without 110 volt line) Charge battery.
3. Battery is low on water. Add distilled water to battery.

AIRSTREAM CLASSIC TRAILER OWNERS MANUAL

PROBLEM: Converter will not charge battery.

CAUSE & REMEDY:

1. In put line not connected. Connect.
2. Battery not connected or polarity reversed. Connect battery to converter (Check polarity).
3. Bad Battery. Replace.
4. Too many lights and appliances. Reduce electrical load

12-VOLT WIRING DIAGRAMS

The main harness leaves the 12-volt distribution panel and runs around the roadside wall **INSIDE** the trailer. In the area of the credenza table and going cross car between the water tanks the harness is under the floor in protective covers.

About halfway back the trailer, the main body interior harness goes up the wall and plugs into the ceiling harness. The ceiling harness runs at the corner junction of the sidewall and ceiling on the curbside with branches running straight out to the lights and fans. All models are pre-wired for solar panel.

The following diagrams list the circuits and show the location of the harness and give the wire color and gauge for each function.

DIAGRAMS:

25 ft. - body interior	34 ft. – body interior
25ft. – ceiling	34 ft. – ceiling
28 ft. - body interior	34 ft. w/so - body interior A
28ft. – ceiling	34 ft. w/so - body interior B
30ft. - body interior	34 ft. w/so – ceiling
30ft. – ceiling	34 ft - slide out room
30ft.S/O - body interior “PT A”	31 ft. – body interior
30ft. S/O – body interior “PT B”	Taillight harness - all models
31 ft. – ceiling	All models – tail light harness

AIRSTREAM CLASSIC TRAILER OWNERS MANUAL

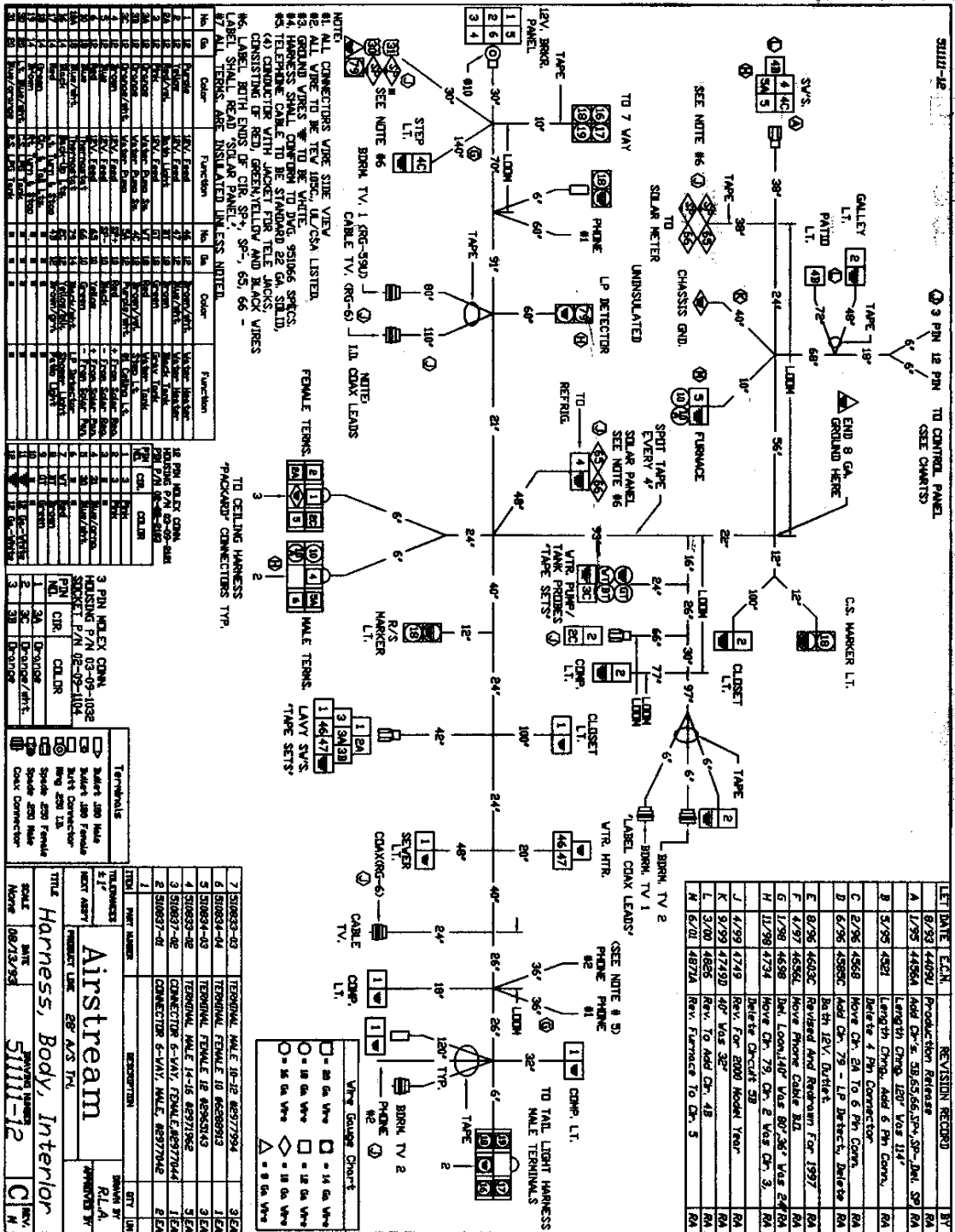

AIRSTREAM CLASSIC TRAILER OWNERS MANUAL

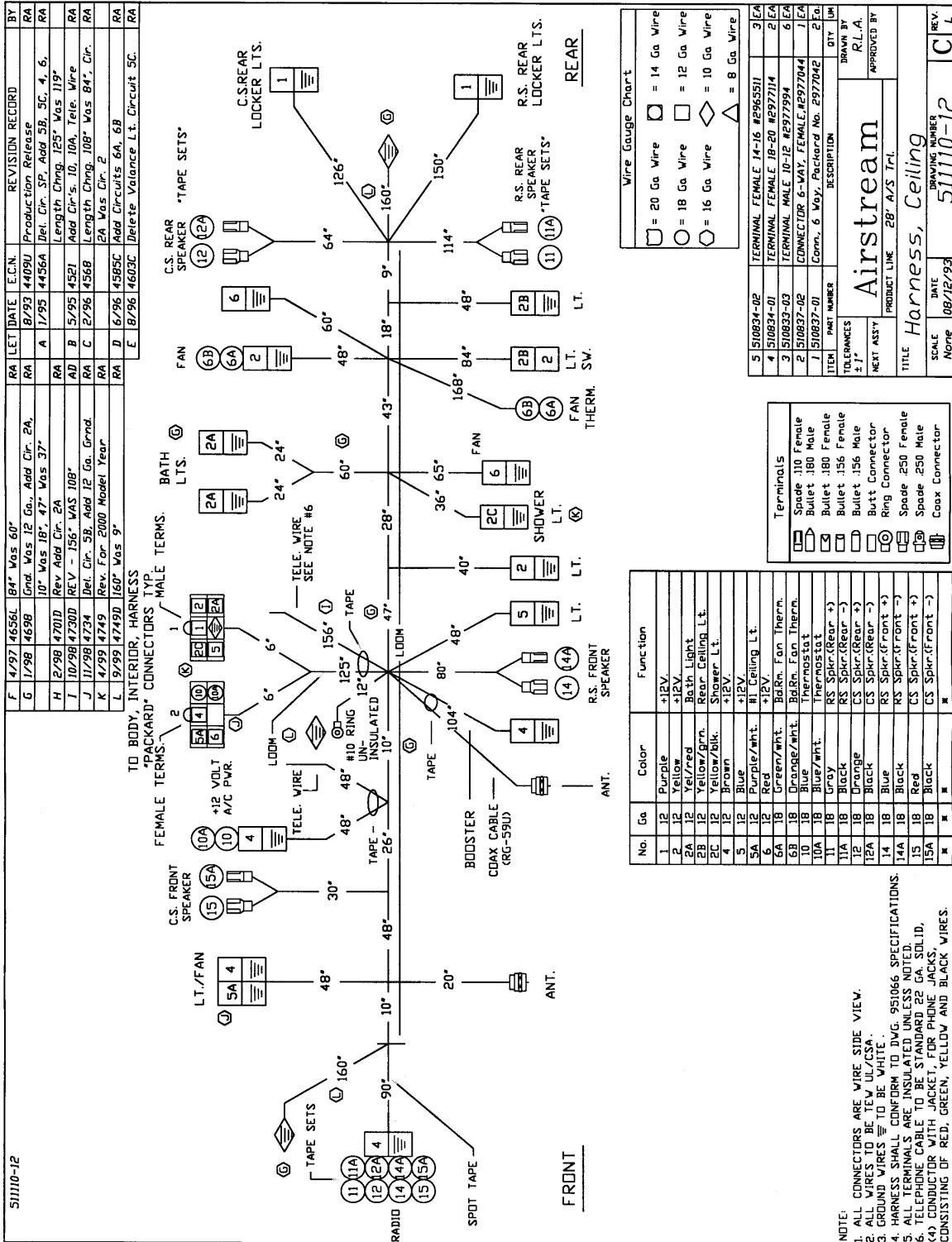

AIRSTREAM CLASSIC TRAILER OWNERS MANUAL

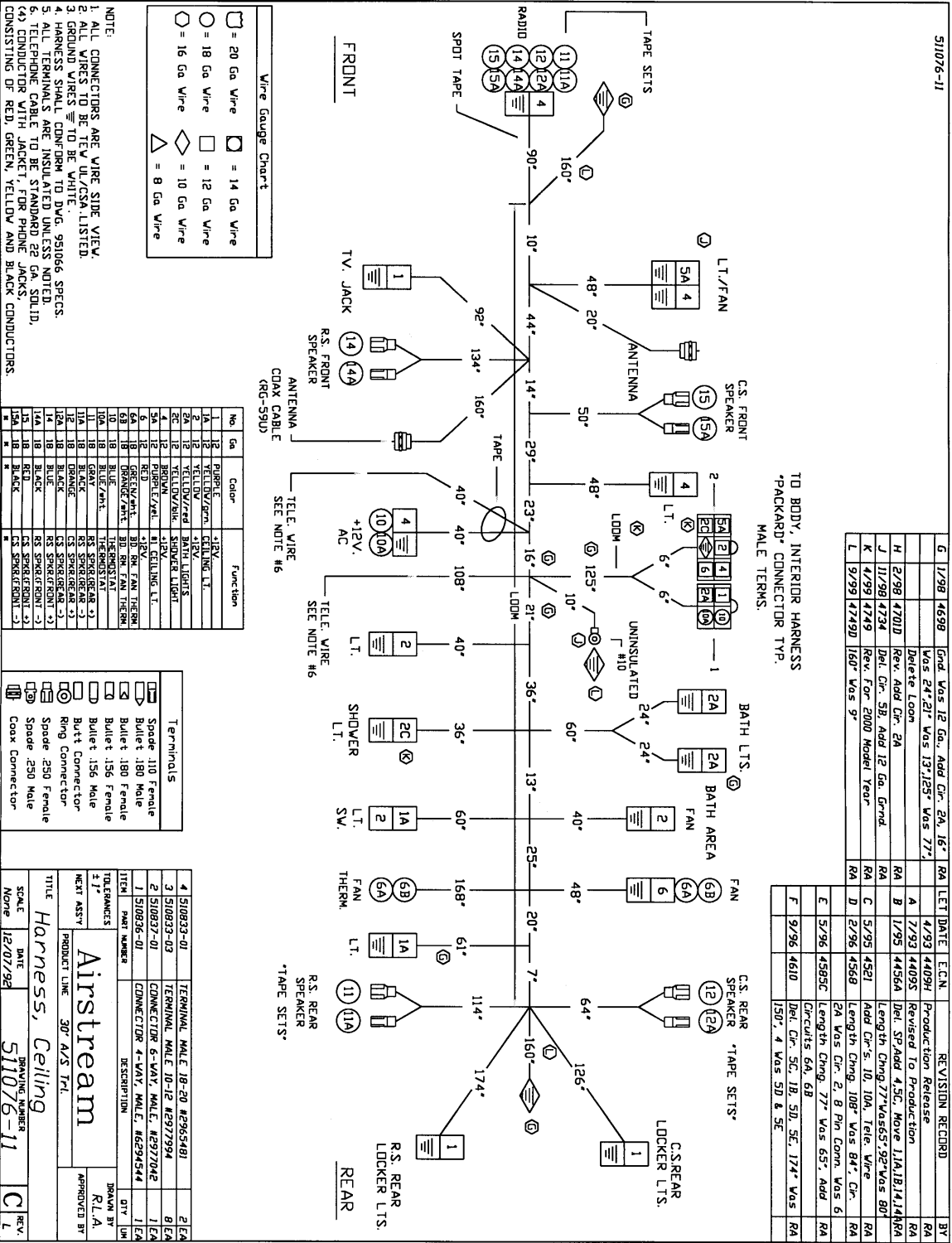

AIRSTREAM CLASSIC TRAILER OWNERS MANUAL

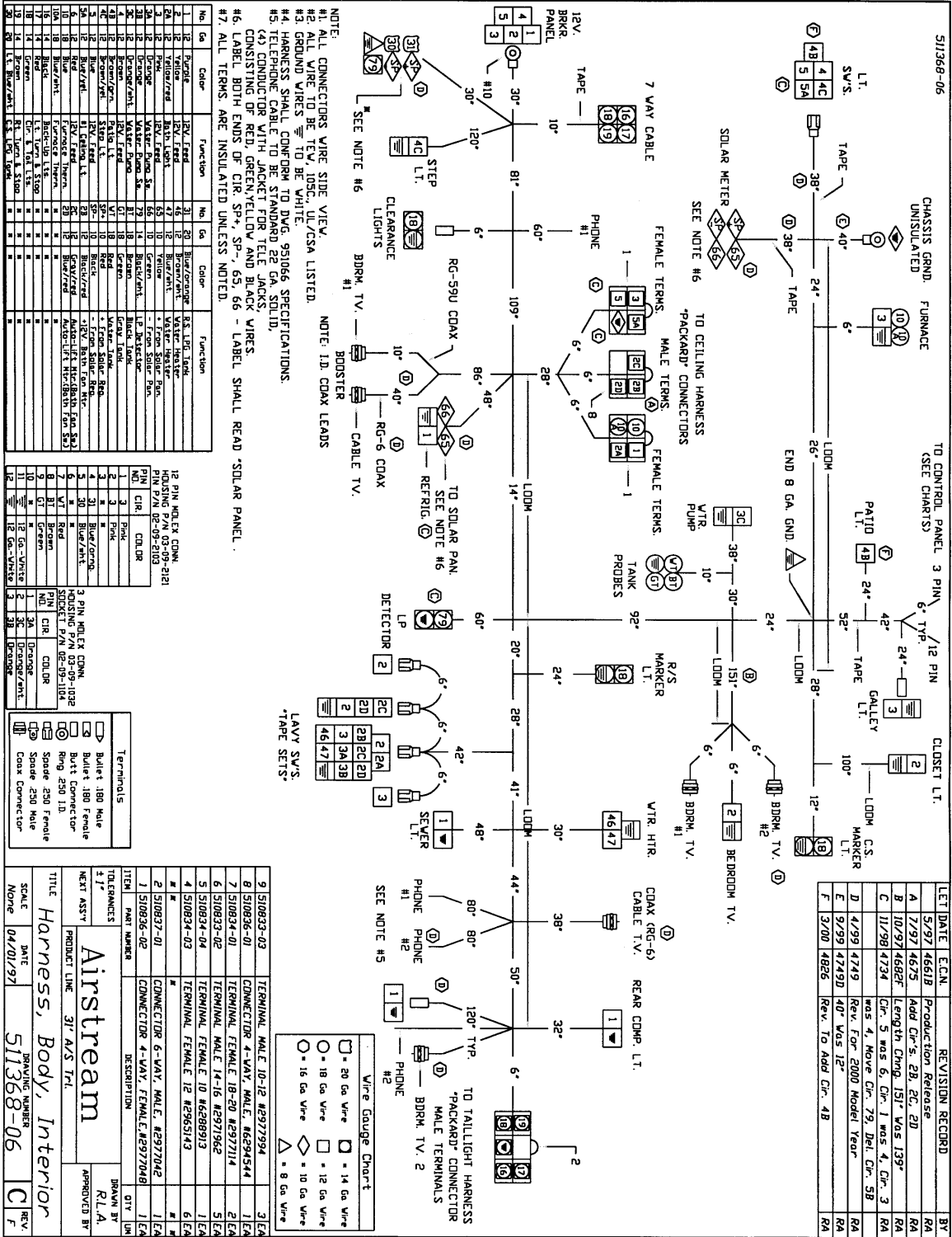

No.	Color	Function	No.	Color	Function
1	Blue	12V. Feed	31	Black/Orange	R.T. LTR. Tank
2	Red	12V. Feed	46	Red	Water Heater
3	Yellow/Red	12V. Feed	47	Black/White	Water Heater
4	Red	12V. Feed	48	Black/White	Water Heater
5	Green	12V. Feed	49	Black/White	Water Heater
6	Green	12V. Feed	50	Black/White	Water Heater
7	Green	12V. Feed	51	Black/White	Water Heater
8	Green	12V. Feed	52	Black/White	Water Heater
9	Green	12V. Feed	53	Black/White	Water Heater
10	Green	12V. Feed	54	Black/White	Water Heater
11	Green	12V. Feed	55	Black/White	Water Heater
12	Green	12V. Feed	56	Black/White	Water Heater
13	Green	12V. Feed	57	Black/White	Water Heater
14	Green	12V. Feed	58	Black/White	Water Heater
15	Green	12V. Feed	59	Black/White	Water Heater
16	Green	12V. Feed	60	Black/White	Water Heater
17	Green	12V. Feed	61	Black/White	Water Heater
18	Green	12V. Feed	62	Black/White	Water Heater
19	Green	12V. Feed	63	Black/White	Water Heater
20	Green	12V. Feed	64	Black/White	Water Heater
21	Green	12V. Feed	65	Black/White	Water Heater
22	Green	12V. Feed	66	Black/White	Water Heater
23	Green	12V. Feed	67	Black/White	Water Heater
24	Green	12V. Feed	68	Black/White	Water Heater
25	Green	12V. Feed	69	Black/White	Water Heater
26	Green	12V. Feed	70	Black/White	Water Heater
27	Green	12V. Feed	71	Black/White	Water Heater
28	Green	12V. Feed	72	Black/White	Water Heater
29	Green	12V. Feed	73	Black/White	Water Heater
30	Green	12V. Feed	74	Black/White	Water Heater
31	Green	12V. Feed	75	Black/White	Water Heater
32	Green	12V. Feed	76	Black/White	Water Heater
33	Green	12V. Feed	77	Black/White	Water Heater
34	Green	12V. Feed	78	Black/White	Water Heater
35	Green	12V. Feed	79	Black/White	Water Heater
36	Green	12V. Feed	80	Black/White	Water Heater
37	Green	12V. Feed	81	Black/White	Water Heater
38	Green	12V. Feed	82	Black/White	Water Heater
39	Green	12V. Feed	83	Black/White	Water Heater
40	Green	12V. Feed	84	Black/White	Water Heater
41	Green	12V. Feed	85	Black/White	Water Heater
42	Green	12V. Feed	86	Black/White	Water Heater
43	Green	12V. Feed	87	Black/White	Water Heater
44	Green	12V. Feed	88	Black/White	Water Heater
45	Green	12V. Feed	89	Black/White	Water Heater
46	Green	12V. Feed	90	Black/White	Water Heater
47	Green	12V. Feed	91	Black/White	Water Heater
48	Green	12V. Feed	92	Black/White	Water Heater
49	Green	12V. Feed	93	Black/White	Water Heater
50	Green	12V. Feed	94	Black/White	Water Heater
51	Green	12V. Feed	95	Black/White	Water Heater
52	Green	12V. Feed	96	Black/White	Water Heater
53	Green	12V. Feed	97	Black/White	Water Heater
54	Green	12V. Feed	98	Black/White	Water Heater
55	Green	12V. Feed	99	Black/White	Water Heater
56	Green	12V. Feed	100	Black/White	Water Heater

12 PIN MUX CONN.	HOUSING P/N 03-09-2101	12 GA. WIRES
1	Pin 1	Blue/White
2	Pin 2	Blue/White
3	Pin 3	Blue/White
4	Pin 4	Blue/White
5	Pin 5	Blue/White
6	Pin 6	Blue/White
7	Pin 7	Blue/White
8	Pin 8	Blue/White
9	Pin 9	Blue/White
10	Pin 10	Blue/White
11	Pin 11	Blue/White
12	Pin 12	Blue/White

3 PIN MUX CONN.	HOUSING P/N 03-09-1032	3 GA. WIRES
1	Pin 1	Blue/White
2	Pin 2	Blue/White
3	Pin 3	Blue/White

Terminal	Terminal	Terminal
1	2	3
4	5	6
7	8	9
10	11	12
13	14	15
16	17	18
19	20	21
22	23	24
25	26	27
28	29	30
31	32	33
34	35	36
37	38	39
40	41	42
43	44	45
46	47	48
49	50	51
52	53	54
55	56	57
58	59	60
61	62	63
64	65	66
67	68	69
70	71	72
73	74	75
76	77	78
79	80	81
82	83	84
85	86	87
88	89	90
91	92	93
94	95	96
97	98	99
100	101	102

LET DATE	E.C.N.	REVISION RECORD	BY
5/97	4661B	Production Release	RA
7/97	4675	Add Cir. 5, 28, 29, 20	RA
10/97	4687	Length Chng. 151" Was 139"	RA
11/98	4734	Cir. 3 Was 6, Cir. 1 Was 4, Cir. 3	RA
4/99	4749	Was 4, Move Cir. 79, Del. Cir. 58	RA
9/99	4749D	Rev. For 2000 Model Year	RA
3/00	4826	40" Was 12"	RA
		Rev. To Add Cir. 48	RA

Airstream
 Harness, Body, Interior
 SCALE: 1/4" = 1'-0"
 DATE: 04/01/97
 DRAWING NUMBER: 51368-06
 APPROVED BY: [Signature]
 REV: C F

AIRSTREAM CLASSIC TRAILER OWNERS MANUAL

511369-10

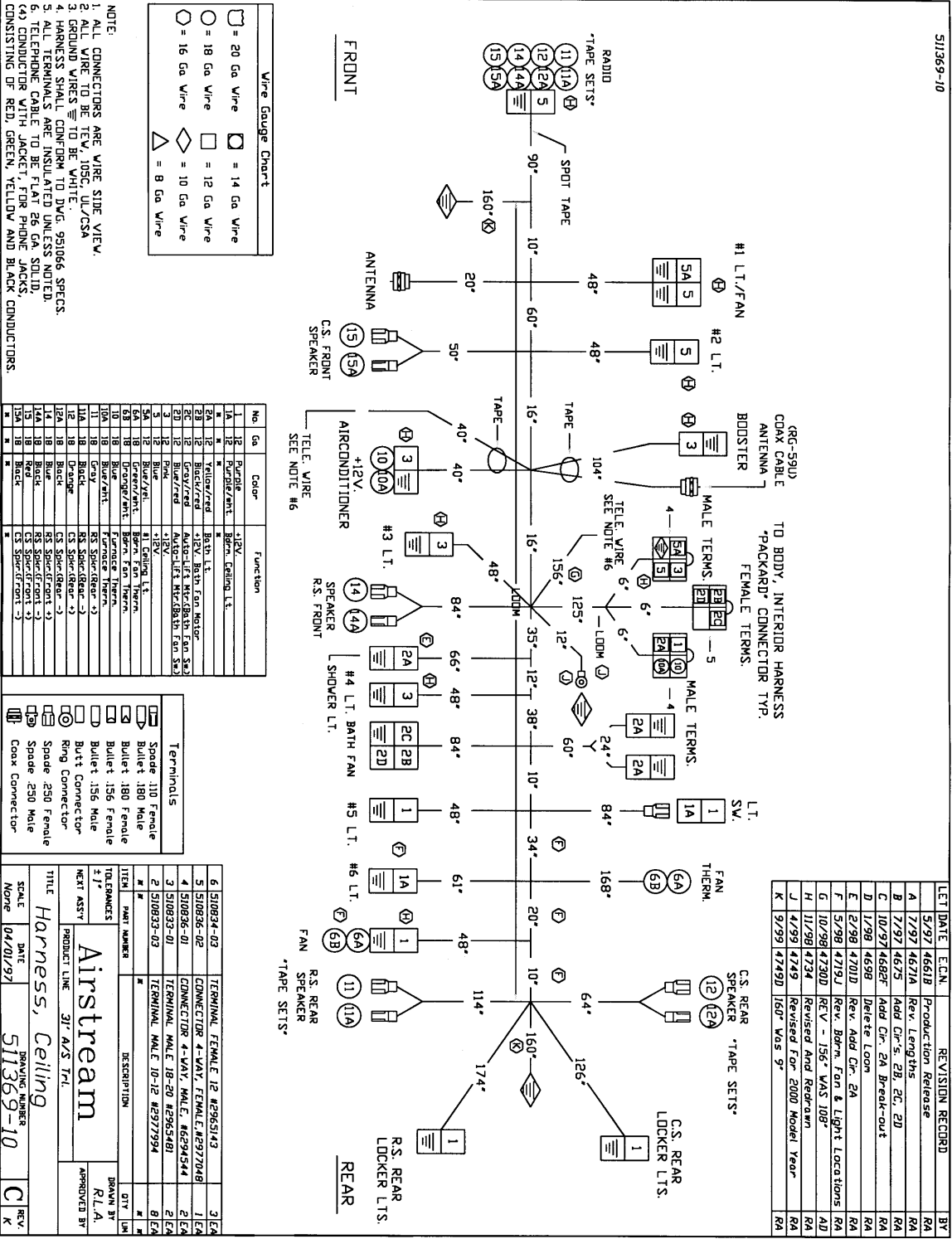

AIRSTREAM CLASSIC TRAILER OWNERS MANUAL

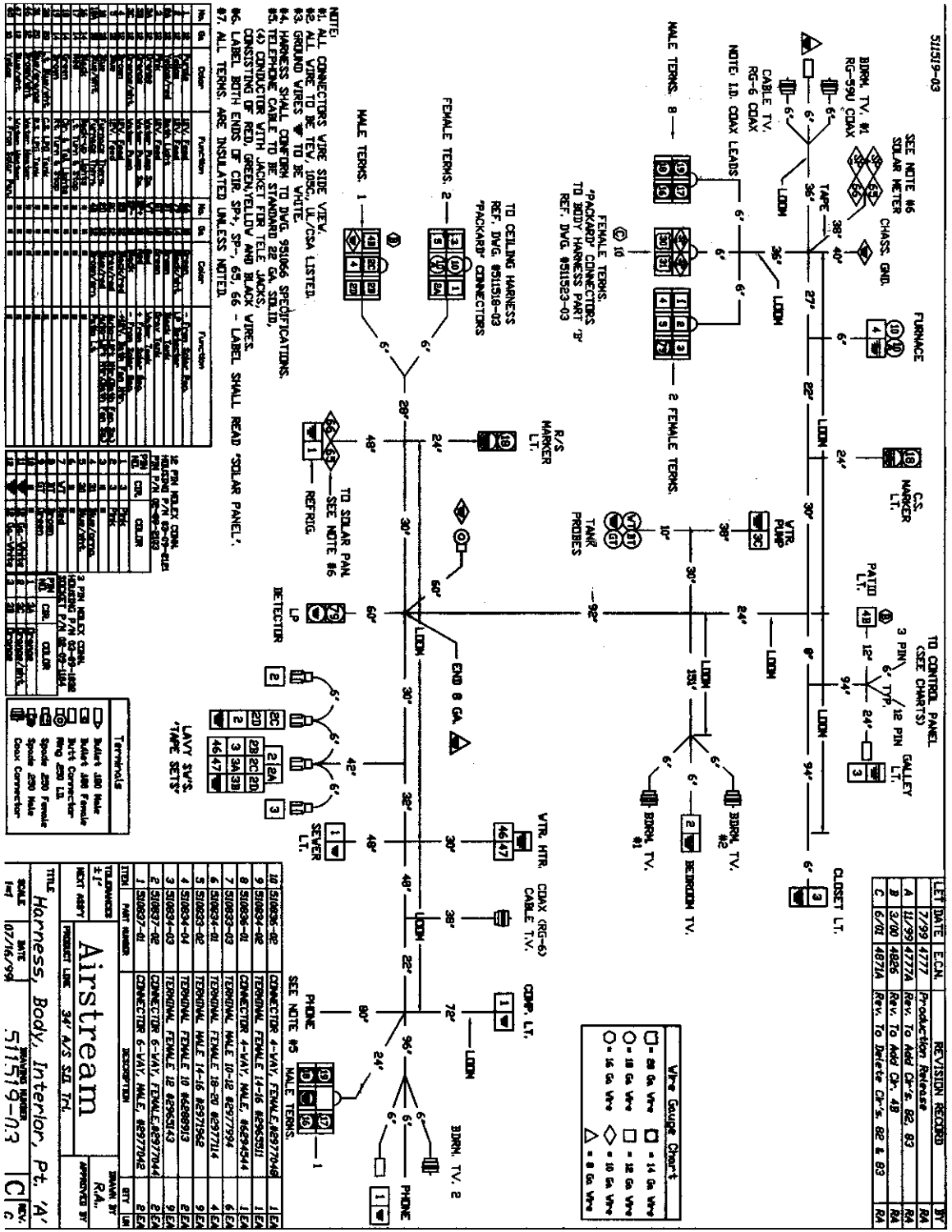

LET DATE	E.C.N.	REVISION REQUIRED	BY
7/29	4777	Production Review	RA
4/79	4777A	Rev. To Add Cr. S. 82, 83	RA
3/00	4826	Rev. To Add Cr. 48	RA
6/01	4871A	Rev. To Inset Cr. S. 82 & 83	RA

LET DATE	07/16/99
SCALE	1" = 1'
TITLE	Harness, Body, Interior, Pt. A'
DATE	07/16/99
REV.	C
REV. NUMBER	511519-03
APPROVED BY	[Signature]
DESIGNED BY	[Signature]
DRAWN BY	[Signature]
CHECKED BY	[Signature]
PROJECT LEAD	34' A/S STD TH.
REV. NUMBER	511519-03

AIRSTREAM CLASSIC TRAILER OWNERS MANUAL

511523-03

WEIGHT:

LET	DATE	ECN	REVISION RECORD	BY
	7/29/93	4777	Production Release	RA
A	11/29/93	4777A	Rev. To Add Ch's. 4B, 50, 51, 52, 53	RA
B	3/00	4886	312" Vols 564', 108" Vol 72"	RA
C	6/01	4971A	Rev. To Div. Ch's. 4B, 50, 51, 52, 53	RA

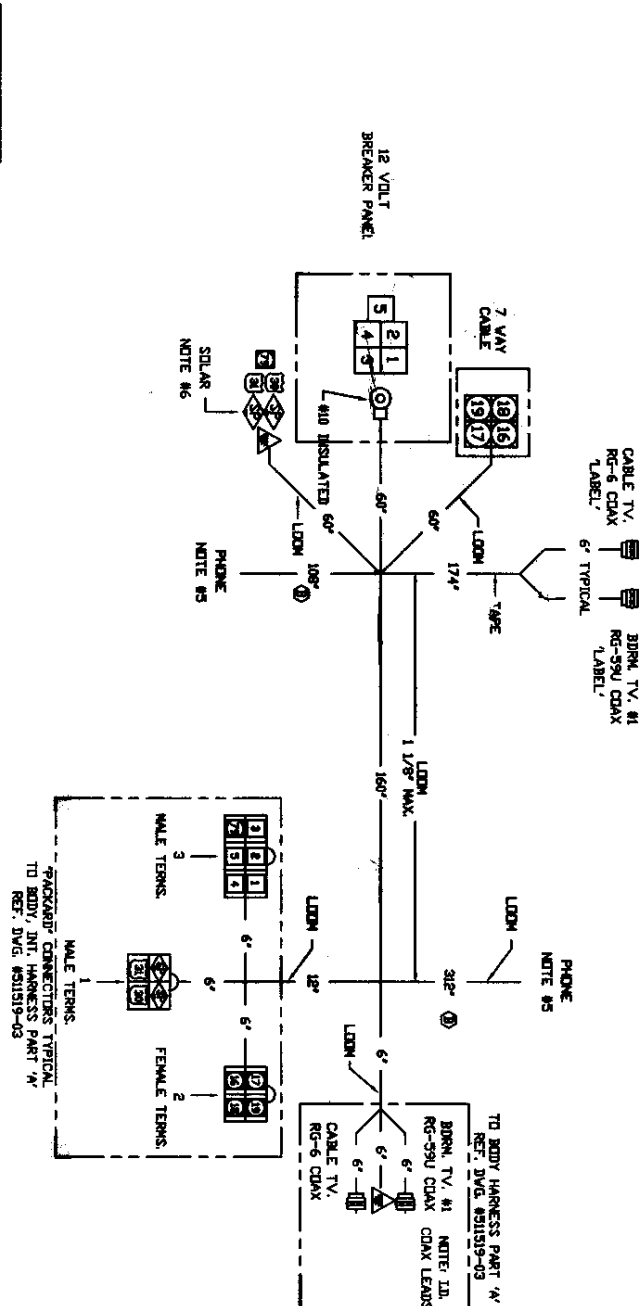

TERMINALS

▶	Bullet 180 Male
◀	Bullet 180 Female
⊙	Ring Connector
⊚	Spade 250 Female
⊛	Spade 250 Male
⊞	Coax Connector

- NOTE:**
- #1. ALL CONNECTORS WIRE SIZE VIEW.
 - #2. ALL WIRES TO BE TEV, JDC, JL, CSA LISTED.
 - #3. GROUND WIRES TO BE WHITE.
 - #4. HARNESS SHALL CONFORM TO DIVG. 991066 SPECIFICATIONS.
 - #5. TELEPHONE CABLE TO BE STANDARD 22 GA. SOLID.
 - #6. CONDUCTOR WITH JACKET FIBER TELE. BLACK WIRES.
 - #7. CABLE TV, BORN TV, PHONE, SOLAR, LABEL SMALL READ.
 - #8. LABEL CAR 312" VOLS.
 - #9. ALL TERMS ARE INSULATED UNLESS NOTED.

WIRE GAUGE CHART

○	14 Ga. Wire
○	16 Ga. Wire
○	18 Ga. Wire
○	20 Ga. Wire
○	22 Ga. Wire
○	24 Ga. Wire
○	26 Ga. Wire
○	28 Ga. Wire
○	30 Ga. Wire
△	8 Ga. Wire

No.	Color	Function
1	RED	BATTERY POSITIVE
2	BLACK	BATTERY NEGATIVE
3	WHITE	GROUND
4	GREEN	GROUND
5	YELLOW	GROUND
6	BLUE	GROUND
7	PURPLE	GROUND
8	BROWN	GROUND
9	PINK	GROUND
10	GRAY	GROUND
11	ORANGE	GROUND
12	SLIVER	GROUND
13	RED	GROUND
14	BLACK	GROUND
15	WHITE	GROUND
16	GREEN	GROUND
17	YELLOW	GROUND
18	BLUE	GROUND
19	PURPLE	GROUND
20	BROWN	GROUND
21	PINK	GROUND
22	GRAY	GROUND
23	ORANGE	GROUND
24	SLIVER	GROUND
25	RED	GROUND
26	BLACK	GROUND
27	WHITE	GROUND
28	GREEN	GROUND
29	YELLOW	GROUND
30	BLUE	GROUND
31	PURPLE	GROUND
32	BROWN	GROUND
33	PINK	GROUND
34	GRAY	GROUND
35	ORANGE	GROUND
36	SLIVER	GROUND
37	RED	GROUND
38	BLACK	GROUND
39	WHITE	GROUND
40	GREEN	GROUND
41	YELLOW	GROUND
42	BLUE	GROUND
43	PURPLE	GROUND
44	BROWN	GROUND
45	PINK	GROUND
46	GRAY	GROUND
47	ORANGE	GROUND
48	SLIVER	GROUND
49	RED	GROUND
50	BLACK	GROUND
51	WHITE	GROUND
52	GREEN	GROUND
53	YELLOW	GROUND
54	BLUE	GROUND
55	PURPLE	GROUND
56	BROWN	GROUND
57	PINK	GROUND
58	GRAY	GROUND
59	ORANGE	GROUND
60	SLIVER	GROUND

Part No.	Color	Function
1	RED	BATTERY POSITIVE
2	BLACK	BATTERY NEGATIVE
3	WHITE	GROUND
4	GREEN	GROUND
5	YELLOW	GROUND
6	BLUE	GROUND
7	PURPLE	GROUND
8	BROWN	GROUND
9	PINK	GROUND
10	GRAY	GROUND
11	ORANGE	GROUND
12	SLIVER	GROUND
13	RED	GROUND
14	BLACK	GROUND
15	WHITE	GROUND
16	GREEN	GROUND
17	YELLOW	GROUND
18	BLUE	GROUND
19	PURPLE	GROUND
20	BROWN	GROUND
21	PINK	GROUND
22	GRAY	GROUND
23	ORANGE	GROUND
24	SLIVER	GROUND
25	RED	GROUND
26	BLACK	GROUND
27	WHITE	GROUND
28	GREEN	GROUND
29	YELLOW	GROUND
30	BLUE	GROUND
31	PURPLE	GROUND
32	BROWN	GROUND
33	PINK	GROUND
34	GRAY	GROUND
35	ORANGE	GROUND
36	SLIVER	GROUND
37	RED	GROUND
38	BLACK	GROUND
39	WHITE	GROUND
40	GREEN	GROUND
41	YELLOW	GROUND
42	BLUE	GROUND
43	PURPLE	GROUND
44	BROWN	GROUND
45	PINK	GROUND
46	GRAY	GROUND
47	ORANGE	GROUND
48	SLIVER	GROUND
49	RED	GROUND
50	BLACK	GROUND
51	WHITE	GROUND
52	GREEN	GROUND
53	YELLOW	GROUND
54	BLUE	GROUND
55	PURPLE	GROUND
56	BROWN	GROUND
57	PINK	GROUND
58	GRAY	GROUND
59	ORANGE	GROUND
60	SLIVER	GROUND

Airstream

PROJECT LINE 34' STD LENGTH T/T

DATE 07/16/99

REV. 1

BY C

REV. 2

BY C

AIRSTREAM CLASSIC TRAILER OWNERS MANUAL

511532

WEIGHT: 350 LBS.

LET	DATE	ECN.	REVISION RECORD	BY
7/99	4777	Production Release		RA

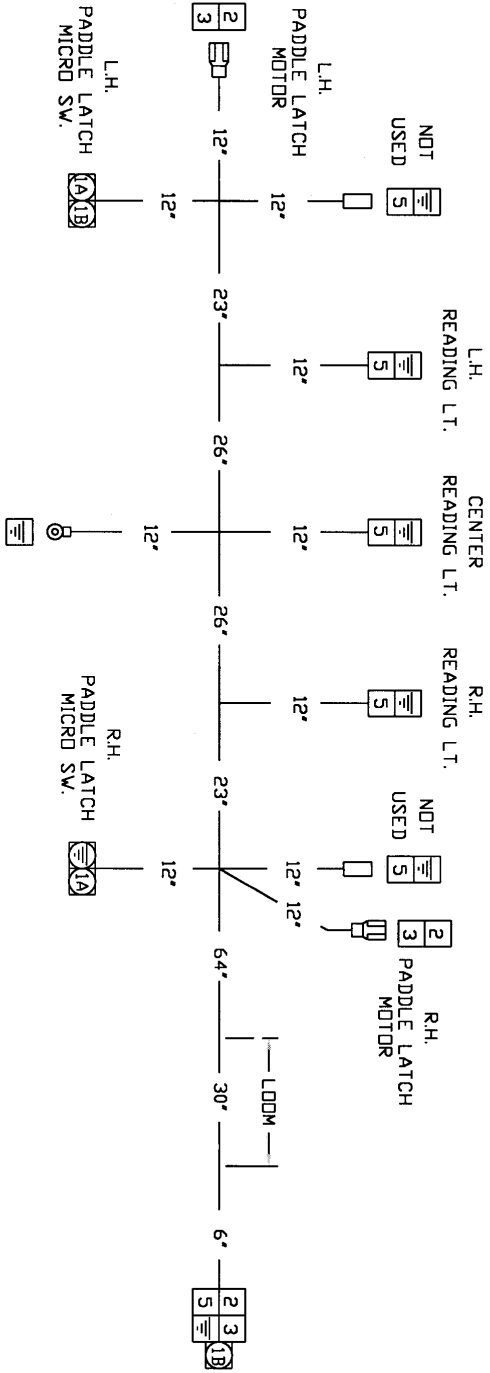

- • 20 Ga Wire
- • 14 Ga Wire
- • 18 Ga Wire
- • 16 Ga Wire
- ◇ • 10 Ga Wire
- △ • 8 Ga Wire

Note:
 1. All wire to be type TEW, 105C, UL/CSA listed.
 2. All ground wire (≡) to be white.

No.	Ga	Color	Function
1A	14	Purple	Paddle Latch Sw.
1B	14	Purple/Ylk.	Paddle Latch Sw.
2	12	Yellow	Paddle Latch Sw. Motor
3	12	Red	Paddle Latch Sw. Motor
5	12	Blue	+12 Volts

Terminals
Butt Conn./Heat shrink
Butt 180 Male
Butt 180 Female
Butt Connector
Ring 250 I.D.
Spade 250 Female
Spade 250 Male
Cook Connector

ITEM	PART NUMBER	DESCRIPTION	QTY	UM
Airstream				
TOLERANCES ± 1'				
NEXT ASSY. PRODUCT LINE 34' S.D. Trl.				
TITLE Harness, S.D. Room, 12V.			DRAWING NUMBER 511532	
SCALE 1-1			DATE 07/27/98	
			APPROVED BY B	
			REV.	

AIRSTREAM CLASSIC TRAILER OWNERS MANUAL

952552

NOTE:
1. THIS IS NOT A SEPARATE HARNESS, BUT IS INCORPORATED IN THE BODY, INTERIOR HARNESS.

No.	Ga.	Color	Function
16	14	BLACK	BACK-UP LIGHTS
17	14	RED	L.T. TURN & STOP
18	14	GREEN	CLR. & TAIL L.T.S.
19	14	BROWN	RT. TURN & STOP
20	14	WHITE	CHASSIS GROUND

ITEM	PART NUMBER	DESCRIPTION	QTY	UM
Airstream				
PRODUCT LINE Trailer - All				
DRAWN BY R.L.A.				
APPROVED BY				
TITLE Lay-out, Tail Light Harness				
SCALE 1=32				
DATE 12/05/95				
DRAWING NUMBER 952552				
REV. B				

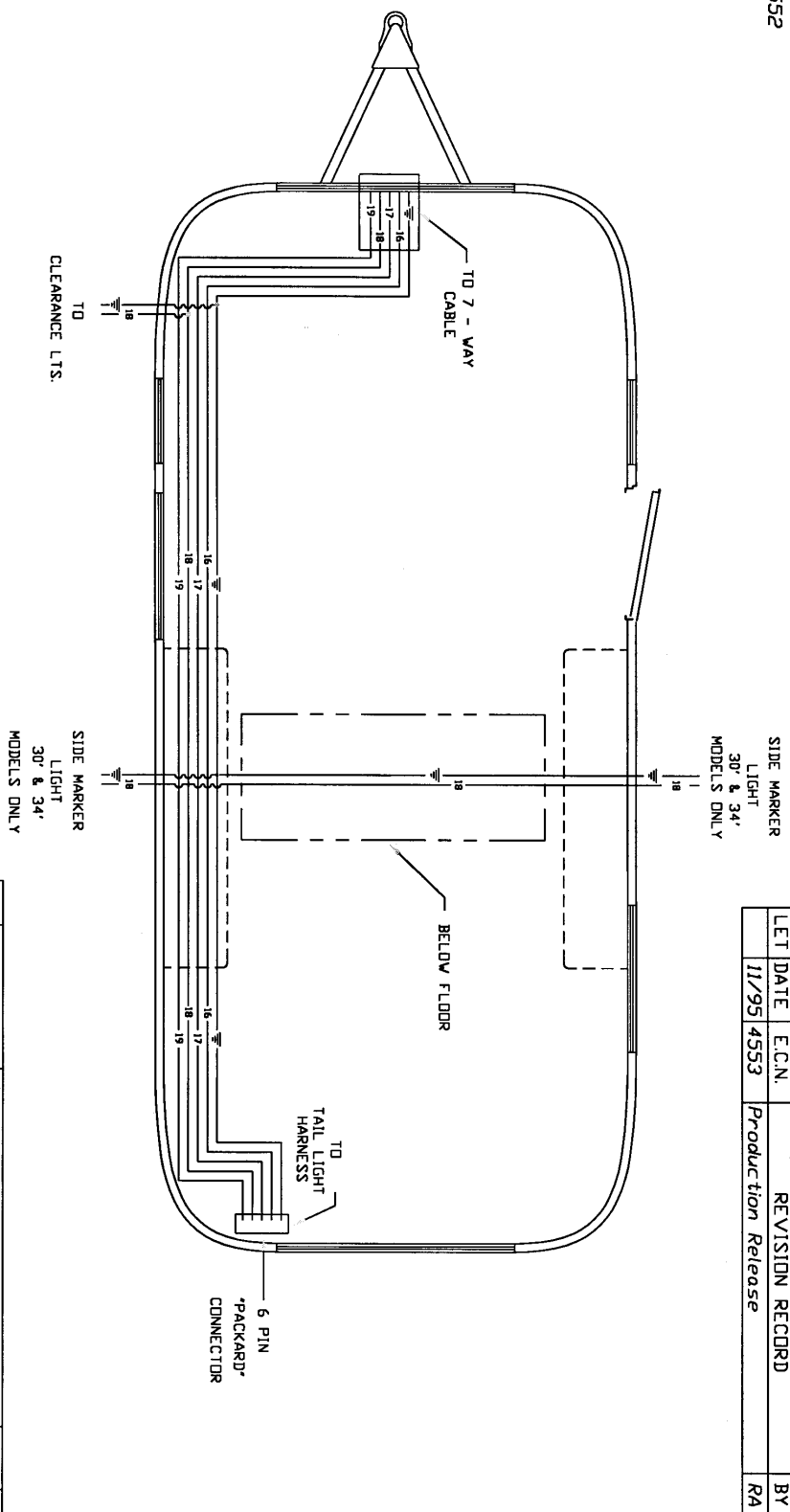

LET	DATE	E.C.N.	REVISION RECORD	BY
	11/95	4553	Production Release	RA

AIRSTREAM CLASSIC TRAILER OWNERS MANUAL

TV ANTENNA

Manufacturer:
Winegard Company
3000 Kirkwood Street
Burlington, Iowa 52601
Phone: 800-843-4741

Raising Antenna to Operating Position

Turn elevating crank in "UP" direction until some resistance to turning is noted. Antenna is now in operating position. Check to make sure switch on front TV jack is on.

Rotating Antenna

Make sure antenna is in "UP" position. Pull down on directional handle with both hands until it disengages ceiling plate and rotate for best picture and sound on television set.

Lowering Antenna to Travel Position

Rotate antenna until pointer on directional handle aligns with pointer on ceiling plate.



WARNING: Antenna must be in "down" position while traveling to prevent damage.

Turn elevating crank in the "Down" direction until resistance is noted. Antenna is now locked in travel position.

Checking Operation

1. Tune TV receiver to nearest station and rotate antenna for best picture and sound.
2. Turn off switch on power supply. Picture on TV receiver should be considerably degraded with the power off.

DO'S

1. Do check parking location for obstructions before raising antenna.
2. Do carefully raise, lower and rotate - if difficult, check for cause.
3. Do rotate slowly when selecting station and check fine-tuning on TV set to make sure it is properly adjusted.
4. Do lower antenna before moving vehicle.

DON'TS

1. Don't force elevating crank up or down. Check for cause of trouble.
2. Don't rotate directional handle hard against stops.
3. Don't travel with lift in up position.
4. Don't leave lift part way up or down.
5. Don't apply sealing compound or paint over top of base plate or anywhere on lift.

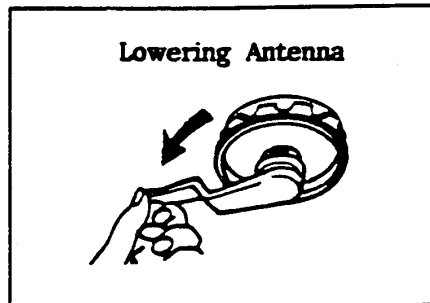
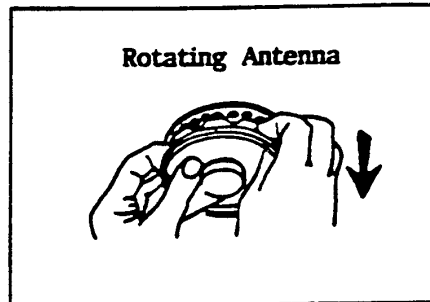
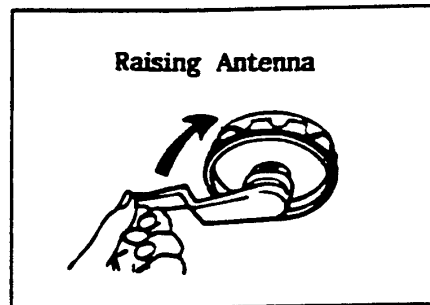

AIRSTREAM CLASSIC TRAILER OWNERS MANUAL

Maintenance

Lubrication

To lubricate the elevating gear apply a liberal amount of silicone spray lubricant to the elevating gear with the lift in the down position, then run the lift up and down a few times to distribute lubricant over gears.

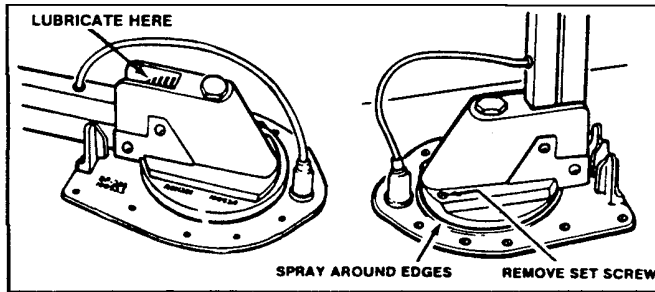

Lubricating Rotating Gear Housing

In the event that rotating the antenna becomes difficult, lubricating the bearing surface between the rotating gear housing and the base plate can restore normal operation. Any spray type silicone lubricant may be used.

Elevate antenna and remove setscrew from rotating gear housing as shown. Spray lubricant into hole and around edges of gear housing. Rotate gear housing until lubricant coats bearing surfaces and antenna rotates freely.

Elevating Shaft Worm Gear Assembly Replacement Procedure

NOTE: It is not necessary to remove the rotating gear housing (11) from the base plate (14) or remove the antenna from the roof to replace the shaft and gear assembly.

STEP 1: Lower antenna to travel position. Loosen set screw on elevating crank (23); remove crank, spring (20), and directional handle (19).

STEP 2: Remove top retaining ring (5) from top pin (4) holding top elevating tube in rotating gear housing and remove pin.

STEP 3: Remove plug from top of rotating gear housing elevating gear (8) and remove elevating shaft assembly (10).

STEP 4: Cut new shaft to same length as one removed.

STEP 5: Lubricate worm gear on new elevating shaft assembly with spray silicone lubricant, make sure wave washer, flat washer and quad ring are on lower bearing and insert assembly in housing.

STEP 6: Install plastic plug in top of housing, re-engage elevating gear in worm gear, replace pin and retaining ring.

STEP 7: Replace directional handle, spring and elevating crank. Make sure setscrew contacts flat on shaft before tightening.

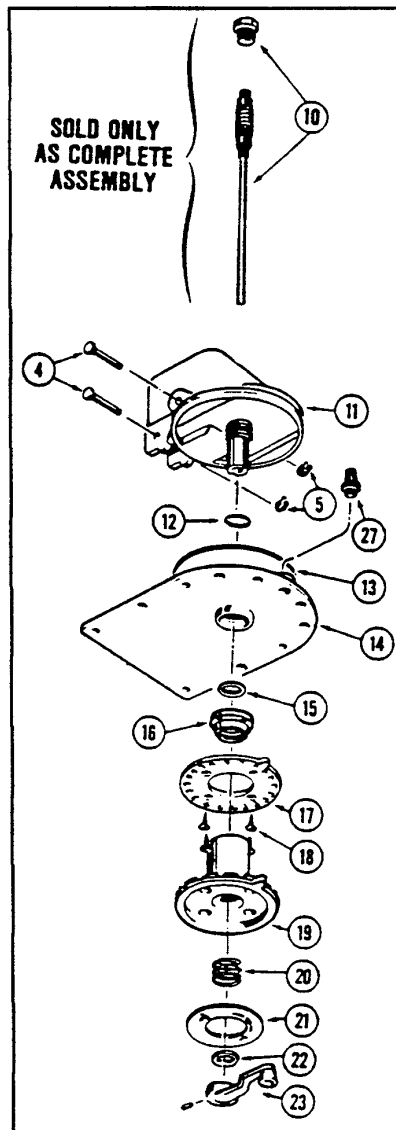

AIRSTREAM CLASSIC TRAILER OWNERS MANUAL

PARTS DESCRIPTION

1. Antenna Head
2. LM-300 Leveling Mount
3. Boot, Coax Cable
4. Pin, Headed/Grooved
5. Ring, Retaining Snap
6. Spacer, Plastic
7. Grommet, Plastic
8. EG-87 Elevating Gear
9. Tube, Square Elevator
10. Elevating Shaft Assy
11. Housing, Rotating Gear
12. Ring Quad Seal
13. Bearing, Nylon
14. Housing, Base Plate
15. Bearing, Nylon
17. Plate, Ceiling
18. Screw
19. Handle, Directional
20. Spring, Handle
21. Decal, Crank Cover
22. Bearing, Nylon
23. Elevating Crank/Set Screw
27. Boot, Gear Housing
30. Bumper, Rubber
31. Screw

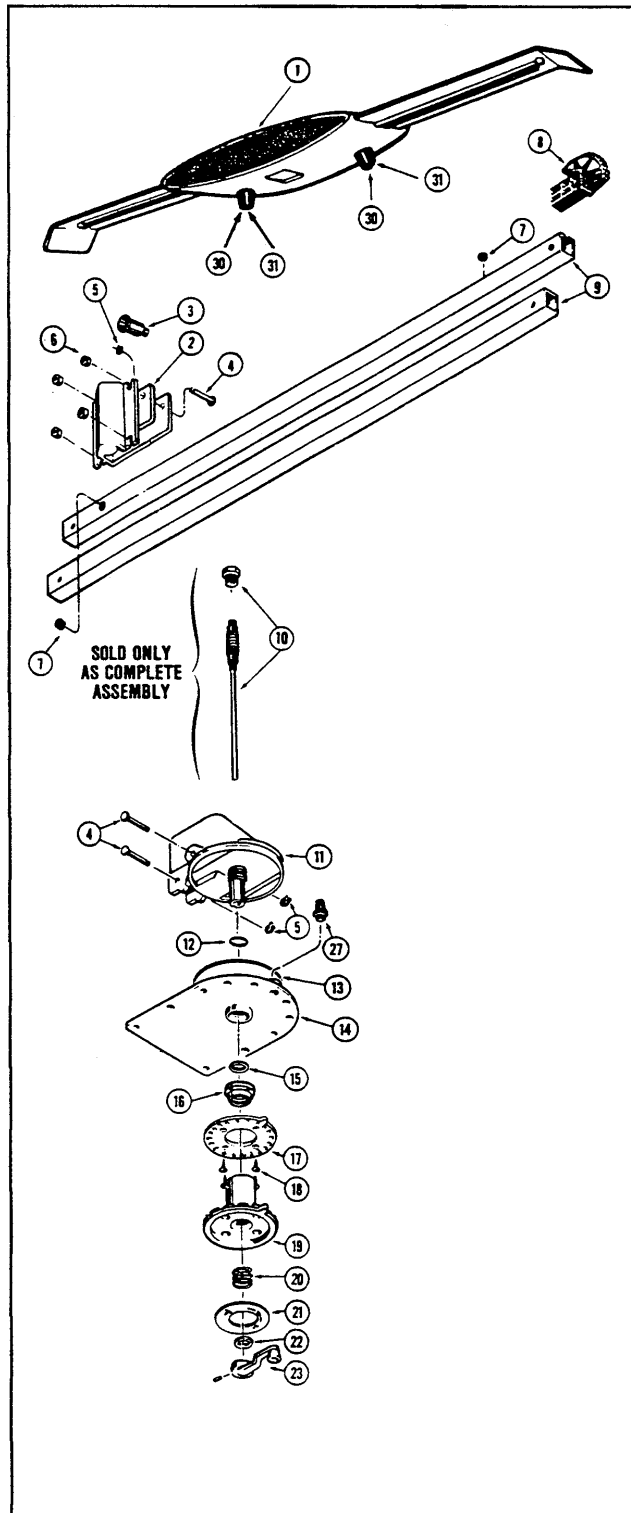

AIRSTREAM CLASSIC TRAILER OWNERS MANUAL

COAXIAL CABLE WITH CABLE HOOK-UP

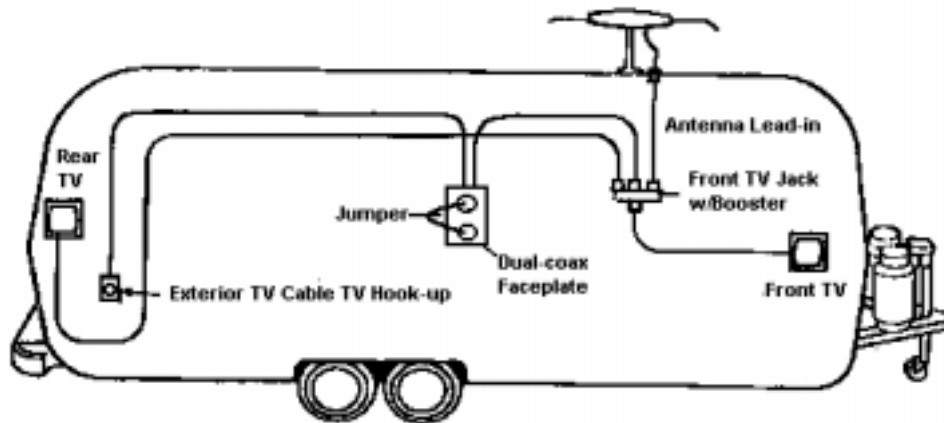

COAXIAL CABLE WITH SATELLITE ANTENNA

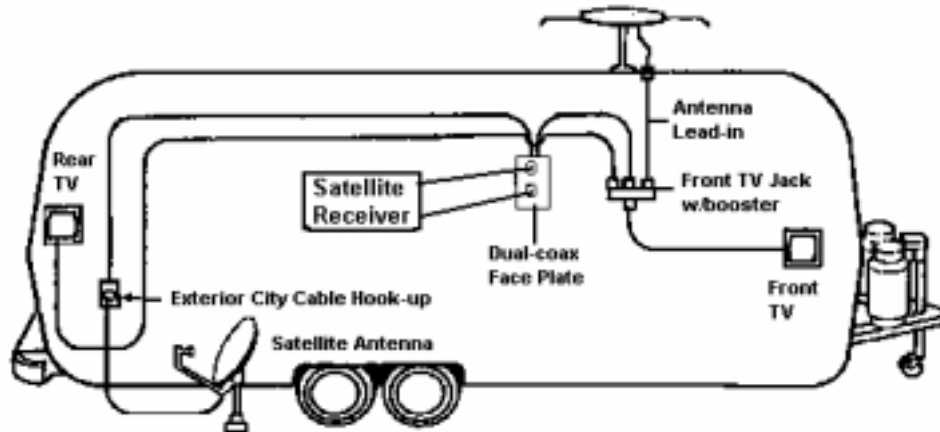

SATELLITE ANTENNA WIRING

If you compare the two previous drawings you'll see wiring for a satellite dish antenna is relatively simple.

Units have a faceplate with two coax cable hook-ups. It is located in the TV credenza on all models except the slide-out model with the overhead TV, which is located in the cabinet to the roadside of the TV. The faceplate has a small coax cable jumper running between the hook-ups to complete the cable TV circuit when in use. To install a satellite system use the following procedure:

1. Remove the jumper wire from the coax faceplate.
2. Hook a portable dish into the Cable TV receptacle in the roadside rear underbelly compartment. This feeds the dish signal to the input side of the faceplate.
3. Install the satellite receiver input and output into the dual coax faceplate.

To return to a cable TV system, remove the satellite receiver from the faceplate and reinstall the jumper cable.

AIRSTREAM CLASSIC TRAILER OWNERS MANUAL

SOLAR PANEL PRE-WIRE

- WIRE SIZE: 10 Ga.
- WIRE COLOR:

1. Positive lead from battery to solar meter/charge controller is RED.
2. Negative lead from battery to solar meter/charge controller is BLACK.
3. Positive lead from solar meter/charge to solar panel is YELLOW (like the sun).
4. Negative lead from solar meter/charge to solar panel is GREEN (like the earth).

- WIRE LOCATION

1. The positive (red) and negative (black) leads that connect to the battery are located behind the sofa and between the two battery compartments on the **CLASSIC** trailer.

CAUTION: The red wire must be fused with a 10-amp in-line fuse at the 12-volt positive.

2. The positive (red) and negative (black) leads from the battery that connect to the solar meter/charge controller are located in the galley cabinet and are clamped to the wall near the forward galley end panel.
3. The positive (yellow) and negative (green) leads that connect to the solar, meter/charge controllers are located in the galley cabinet and are clamped to the wall near the forward galley end panel. These wires are in the same bundle as the red and black battery leads.
4. On all units the positive (yellow) and negative (green) leads for the solar panel are found in the exterior refrigerator compartment.

NOTE: All wires are identified at all locations.

AIRSTREAM CLASSIC TRAILER OWNERS MANUAL

BATHROOM EXHAUST FAN ASSEMBLY

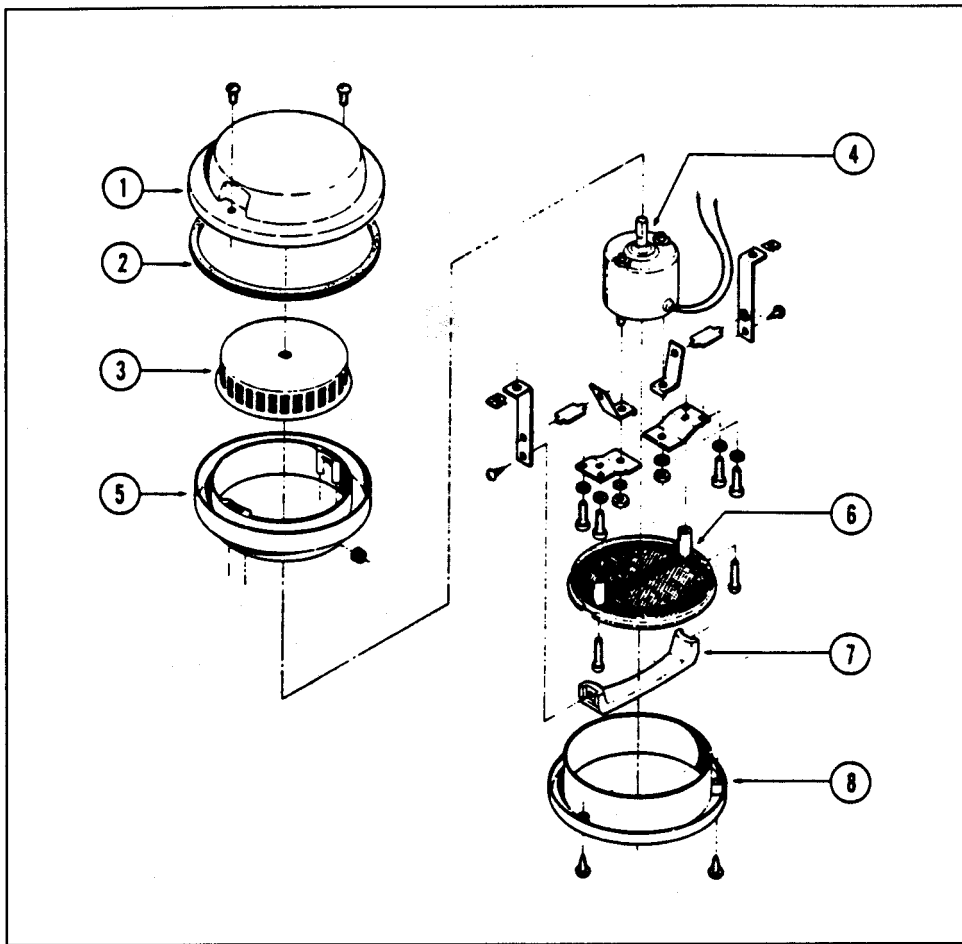

1. Cover Assy w/gaskets
2. Gasket Assy
3. Blower wheel Assy
4. Motor Assy
5. Ring Body Assy
6. Grille Assy
7. Handle Assy
8. Trim Ring Assy

Removal and Replacement

1. Working from the outside top of trailer, remove the screws holding the fan protective cap, and remove the cap.
2. Remove the 6 screws securing the fan flange to the outer skin.
3. Pull the fan out to the extent of the wiring harness and unplug the harness.
4. Remove the fan assembly.
5. To install, reverse the removal procedures.

AIRSTREAM CLASSIC TRAILER OWNERS MANUAL

MONITOR PANEL

MicroPulse Systems Monitor
CATCON PRODUCTS INC.
817-921-2188
techsupport@catconproducts.com



The MicroPulse System makes use of a single solid-state sensor per tank. The MicroPulse sensor measures the static (head) pressure at the bottom of the tank and transmits this information to the MicroPulse System Monitor. Knowing this pressure value, after a one-time calibration has been performed, the MicroPulse System will calculate and accurately display the tank level in 1/8 increment.

A single sensor is installed on the sidewall of each tank, near the bottom, via a 3/4" female NPT spin-in thread. The sensor is solid state, there are no moving parts to wear or maintain. Because the principle of operation does not involve any electrical current flow through the tanks contents (conducted or induced), the nature of the fluid in the tank is unimportant.

The monitor system has been calibrated at the factory and should never need another calibration. If you feel the system is not operating correctly, please contact CATCON Products or a local Airstream dealer. The following instructions are provided for qualified service technicians.

MONITOR WIRE CONNECTIONS

Red	12VDC, Battery Only
Black	Ground, Battery Only
Purple	Water Pump, 15A, 12VDC
White	LPG Sensor, 90 ohm
Fresh	Fresh Tank Sensor
Gray 1	Gray 1 Sensor
Gray 2	Gray 2 Sensor
Black	Black Sensor

AIRSTREAM CLASSIC TRAILER OWNERS MANUAL

MICROPULSE SYSTEMS MONITOR OPERATION INSTRUCTIONS

This example shows the monitor reporting the following:

Fresh Water = 1/8 to Empty
Gray Water 1 = Empty to 5/8
Gray Water 2 = 3/4
Black Water = Empty to 5/8
LP Gas = 1/4
Battery = Empty to 5/8

**On all diagrams the Letters R=Red, Y=Yellow,
G=Green, Blank=no LED lit.**

NORMAL OPERATION

The MicroPulse Monitor will display the condition of each system at all times. The tri-color LED beside the system will indicate the condition of the system using the following color code.

Fresh Water, LP Gas, Battery are as follows:

Green LED = 3/8 to Full
Yellow LED = 1/4
Red LED = 1/8 to Empty

Gray Water, Black Water are as follows:

Green LED = Empty to 5/8
Yellow LED = 3/4
Red LED = 7/8 to Full

TO OBTAIN EXACT READING

To obtain an exact reading of all systems press and release the status button one time. The monitor will flash the LED beside the system it is about to report. It will then display the exact condition of that system by lighting the bar graph from Empty to Full. The monitor will display the exact condition of each system and then return to normal operation mode.

To obtain an exact reading of an individual system press and release the status button until the LED beside the system that you want the condition of is lit. Release the status button and the monitor will display the exact condition of that system by lighting the bar graph from Empty



AIRSTREAM CLASSIC TRAILER OWNERS MANUAL

MICROPULSE SYSTEMS MONITOR CALIBRATION PROCEDURE

STEP 1

Action: Turn the power on.

Result: Display will flash all yellow 1 time, flash all green 5 times and then display all green. This confirms that the monitor is in the calibration mode. Proceed to step two.

Display after completion of step one.

On all diagrams the Letters R=Red, G=Green, Y=Yellow, Blank=no LED lit.

MONITOR DISPLAY	
G	FRESH WATER
G	GRAY WATER 1
G	GRAY WATER 2
G	BLACK WATER
G	LP GAS
G	READY FOR FULL
G	READY FOR EMPTY
G	SELECT TANK
G	DIAGNOSTICS

STEP 2

Action: Press and release the status button one time.

Result: This enters the monitor into diagnostics. Display will light the Fresh Water, Gray Water 1, Gray Water 2, Black Water, and LP Gas. The Diagnostic LED will light green. If a sensor is installed and is working correctly, the LED beside the system will light green. If a sensor is not installed or is not connected, the LED beside the system will display yellow. **If a system LED displays yellow, it will not be included in the calibration routine.** The most likely cause is the RJ11 connectors are not installed correctly or the sensor is not plugged in. When all installed systems are displaying a green LED, proceed to step 3.

Display after completion of step 2.

On all diagrams the Letters R=Red, G=Green, Y=Yellow, Blank=no LED lit.

MONITOR DISPLAY	
G	FRESH WATER
G	GRAY WATER 1
Y	GRAY WATER 2
G	BLACK WATER
Y	LP GAS
	READY FOR FULL
	READY FOR EMPTY
	SELECT TANK
G	DIAGNOSTICS

AIRSTREAM CLASSIC TRAILER OWNERS MANUAL

STEP 3

Action: Press and release the status switch 1 time.

Display will light Fresh Water, Gray Water 1, Gray Water 2, Black Water, and Select Tank LED's green. After 2 seconds, the Select Tank LED will turn off and the ready for empty LED will turn light green. Proceed to step 4.

On all diagrams the Letters R=Red, Y=Yellow, Blank=no LED lit.

Display after completion of step 3.

On all diagrams the Letters R=Red, G=Green, Y=Yellow, Blank=no LED lit.

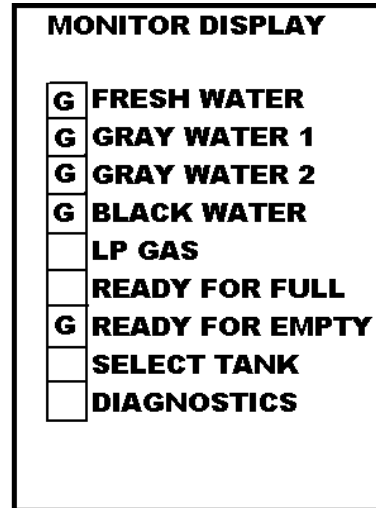

STEP 4

Action: Fill all water holding tanks to the level that you want the monitor to report empty. Minimum suggested is liquid just covering the sensor. When all tanks are set to the desired level press and release the status button 1 time.

Result: Display will go blank for a few moments while the empty values are being read. When the system has completed reading the empty values Fresh Water, Gray Water 1, Gray Water 2, Black Water, and the Ready For Full LED's will light green. Proceed to step 5.

Display after completion of step 4.

On all diagrams the Letters R=Red, G=Green, Y=Yellow, Blank=no LED lit.

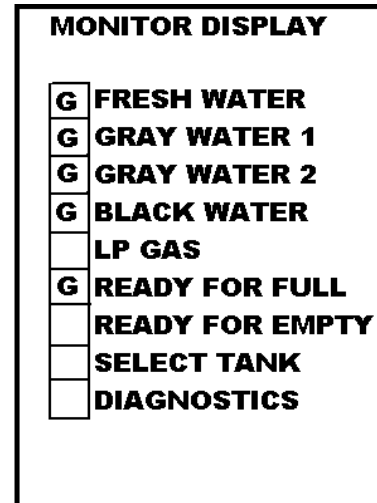

AIRSTREAM CLASSIC TRAILER OWNERS MANUAL

STEP 5

Action: Fill all tanks to the level that you want the monitor to report full. Maximum suggested is liquid about 1 inch below the top of the tank and the maximum is 4 inches above the empty level. When all tanks are set to the desired level press and release the status button 1 time.

Result: Display will go blank for a few moments while the full values are being read. When the system has completed reading the full values Fresh Water, Gray Water 1, Gray Water 2, Black Water, and LP Gas will light. All other LED's will turn off. If a system has passed calibration the LED beside it will light Green. If a system was not installed, the LED beside it will light yellow and that system will not be reported in normal operation. If a system fails calibration the LED beside it will light red and that system will not be reported in normal operation. In the event that a system fails calibration, turn off the monitor and repeat calibration procedure. The most likely cause for a failure is that the full level was not set the minimum of 4 inches above the empty level. If all installed systems display a green LED proceed to step 6.

In this example Fresh, Gray 1, and Black have passed calibration. Gray Water 2 and LP Gas were not installed and therefore they will not be reported in normal operation.

Display after completion of step 5.

**On all diagrams the Letters R=Red, G=Green, Y=Yellow,
Blank=no LED lit.**

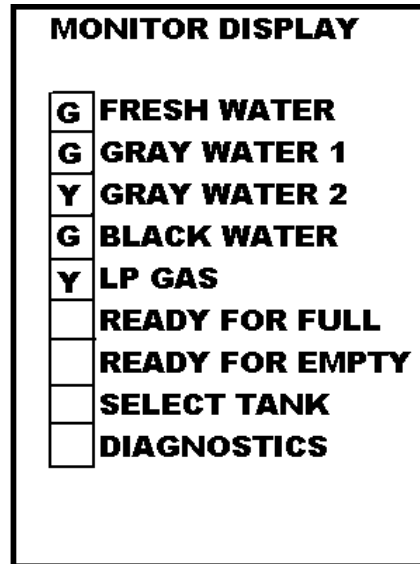

STEP 6

Action: Remove the calibration decal on the lower 4 LED's. Press and release status button 1 time.

Result: Display will turn red from empty to full 1 time, turn green from empty to full 1 time, and all flash green 1 time. Power on greeting will be played and installed tank levels will be displayed.

Calibration is complete

AIRSTREAM CLASSIC TRAILER OWNERS MANUAL

110-VOLT ELECTRICAL SYSTEM

City Power

The Airstream converter system enables you to use the lights and appliances whether operating on self-contained battery power or hooked up to 110 volt city power. The 12-volt light bulbs give off the same light as regular household bulbs, so that when operating on self-contained battery power, everything works normally except the 110-volt convenience outlets and 110-volt appliances.

Exterior outlets for 110 volts are located on the curbside exterior wall.

CAUTION: When operating with city power make very certain that the service is 110 volt and not 220 volt.

The converter system is designed to maintain constant output voltages regardless of the variances that occur in city power systems. The transformer design eliminates the need for complex electronic sensing systems to charge the battery, minimizing the possibility of failures and greatly increasing its overall reliability.

CAUTION: Your Airstream has a gas electric water heater. Make sure the 110-volt water heater switch in the bathroom is turned off when you plug your trailer in to city power. If your plumbing and water heater are full of water the switch may be left in the on position.



WARNING: When the three-pronged plug can be used there will be no problems with proper polarity or grounding.

In some older parks and other locations where three pronged outlets are not available, certain precautions to insure proper grounding and polarity must be taken. These precautions are listed below:

1. Attach the three-pronged plug to a two-pronged adapter. The third conductor line of this adapter has a short wire lead, which must be grounded.
2. For proper grounding connect the short ground lead to a grounded outlet box or to a cold water pipe. When no water pipe is available drive a metal rod two feet into the ground and attach the ground lug to it, thus providing the unit with proper grounding.

To operate self-contained, simply disconnect the power supply cable.

When your trailer is hooked up to 110 volt AC the converter system automatically charges the trailer batteries and, if the 7-way connector is hooked up, your tow vehicle battery as well. The speed and degree of charge depends on how much power is used for lights and appliances, as only the surplus goes to charging the battery. If you are making an extended stay, then you should, if it is available, keep your trailer hooked up to a 110 volt current.

Circuit breakers for the 110-volt system are located in the roadside rear corner of the trailer in the overhead cabinet. Trailers with CSA approval may have the circuit breaker box under the bed or lower cabinet.

While you are connected to the 110-volt receptacle the wiring is protected by circuit breakers in the breaker panel. **In the event of a failure of a 110-volt circuit check your circuit breakers first.** If a breaker continues to trip after you have reset it several times, your circuit may be overloaded with appliances or there may be a short in the circuit. The 110-volt switch on the water heater, with its 12 amp draw, would be one of the easiest places to reduce the load on 110-volt circuits. If lessening the load does not solve the problem consult an Airstream Service Center.

The 110-volt electrical system provides power to operate the air conditioner, converter and 110-volt receptacles for portable appliances. The power is carried through the 110-volt city power flexible cord to the 110-volt distribution panel, and then is distributed to each appliance or receptacle.

All wire, components, and wiring methods conform to federal and state requirements.

AIRSTREAM CLASSIC TRAILER OWNERS MANUAL

TYPICAL 110 VOLT BREAKER PANEL.

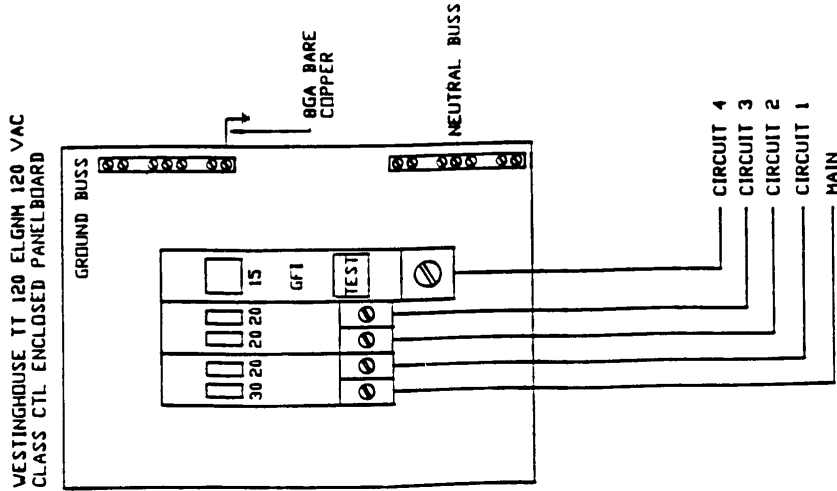

MAIN

- CIRCUIT 1, 20 AMP HACR BREAKER, 12-2 ROMEX W/GROUND, FRONT/REAR A/C'S.
- CIRCUIT 2, 20 AMP HACR BREAKER, 12-2 ROMEX W/GROUND, BEDROOM, CONVERTER, LIVING AREA.
- CIRCUIT 3, 20 AMP HACR BREAKER, 12-2 ROMEX W/GROUND, MICROVAVE
- CIRCUIT 4, 15 AMP GFI BREAKER, 12-2 ROMEX W/GROUND, LEG 1, BATH, OUTSIDE, REFER, GALLEY AREA, DINETTE.

USAGE:

- A/S TRAILERS-25'SB, 28'SB
- 30'FK, 30'SB, 34'SB
- A/S MOTORHOMES-360, 360 PUSHER
- LAND YACHT MOTORHOMES-30'SB, 33'SB,
- 34'SB PUSHER, 36'SB
- LAND YACHT LE-30'SB, 34'SB,
- 34'SB PUSHER

ITEM	PART NUMBER	DESCRIPTION	QTY	UN
TOLERANCES				
3				
NEXT ASSY				
PRODUCT LINE		SEE NOTE		
TITLE		30 AMP. BREAKER PANEL		
SCALE	DATE	DRAWING NUMBER		REV.
NONE	03/03/94	952489		B

AIRSTREAM CLASSIC TRAILER OWNERS MANUAL

GROUND FAULT CIRCUIT INTERRUPTER (GFCI)

Many states require trailers which are sold in their state, and which have exterior 110 volt receptacles, to have a ground fault circuit interrupter.

Trailers manufactured for sale in these states have type THQL 15 amp GFCI breakers installed on the general circuit, since the exterior breaker is on this circuit. The breaker replaced the standard TQL-15 amp breaker.

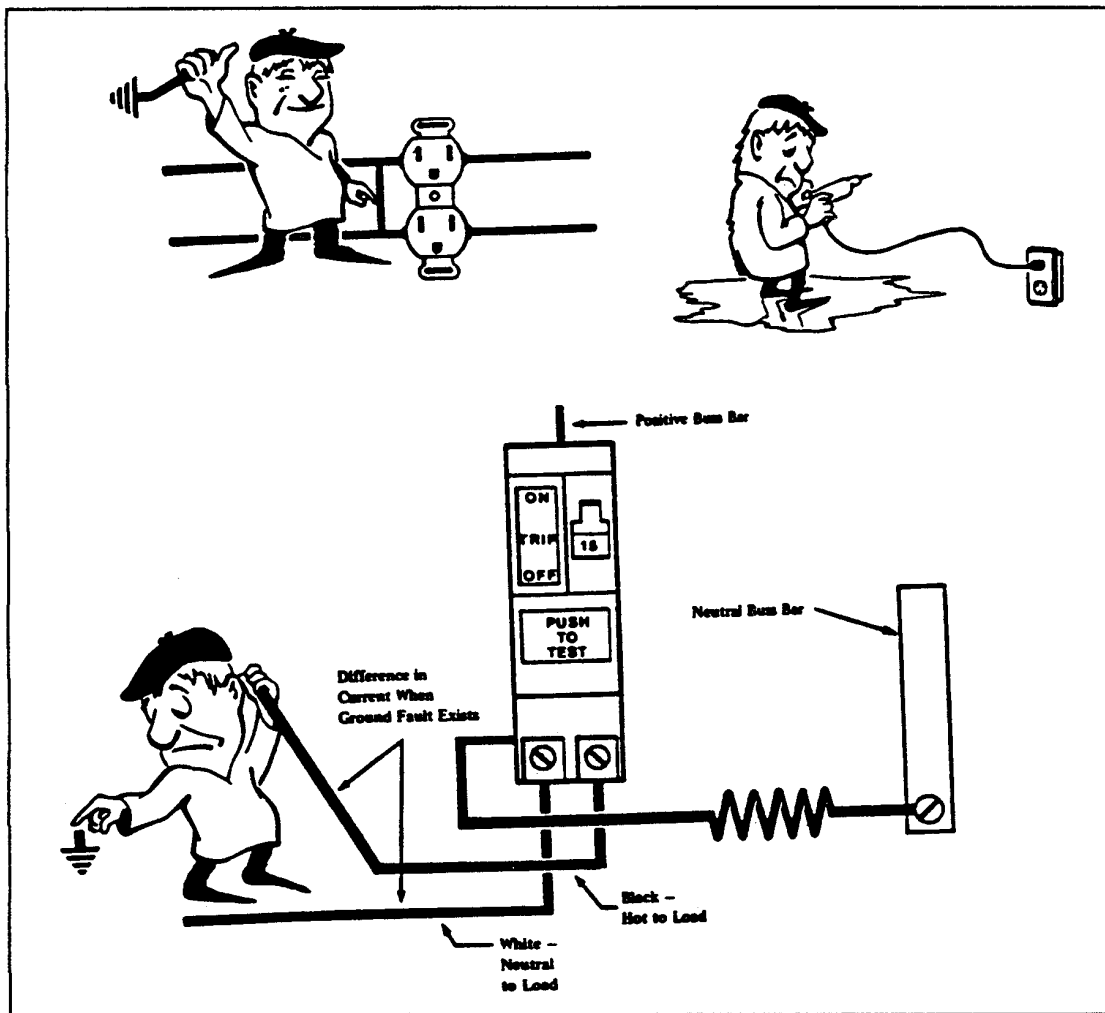

When properly installed, the GFCI circuit breaker provides reliable overload and short circuit protection PLUS protection from Ground Faults that might result from contact with a "HOT" load wire and ground.

IMPORTANT NOTE: The GFCI circuit breaker will NOT reduce shock hazard if contact is made between a "HOT" load wire and a neutral wire or 2 "HOT" load wires.

Each GFCI circuit breaker is calibrated to trip with a ground current of 5 milliamperes or more. Since most persons can feel as little as 2 milliamperes, a distinct shock may be felt if the need for protection exists. However, the shock should be of such short duration that the effects would be reduced to less than the normally dangerous level. However, persons with acute heart problems or other conditions that can make a person particularly susceptible to electric shock may still be seriously injured.

AIRSTREAM CLASSIC TRAILER OWNERS MANUAL

While the GFCI circuit breaker affords a high degree of protection, there is no substitute for the knowledge that electricity can be dangerous when carelessly handled or used without reasonable caution.



WARNING: The GFCI circuit breaker provides protection only to the circuit to which it is connected. It does NOT provide protection to any other circuit.

OCCUPANT:

Make this test each month and record the date on the chart.

1. With handle B in "ON" position, press PUSH TO TEST button A.
2. Handle B should move to TRIP position, indicating that GFCI breaker has opened the circuit.
3. To restore power move handle B to "OFF" and the to "ON"

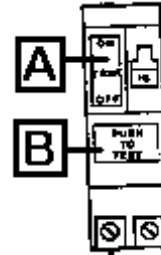

Important: If handle B does not move to TRIP position when test button is pressed, the GFCI breaker protection is not complete. If this happens, replace GFCI breaker.

	JAN	FEB	MAR	APR	MAY	JUN	JUL	AUG	SEP	OCT	NOV	DEC
2004												
2005												
2006												
2007												
2008												

Remote Generator Hook Up (optional equipment)

The remote generator hook up will be located on the front plate of the trailer just behind the LPG bottles. A generator can be plugged into the 110-volt system using this plug and a power cord supplied separately with this option.

The system includes a automatic transfer switch to prevent a power overload if a generator is started while the trailer's 110-volt shoreline is plugged into a 30 amp service. The transfer switch will automatically switch power from a shoreline source to a generator when it senses power entering the switch from the generator. When power is cut from the generator, the switch returns to the shoreline as its power source.

A minimum of 5.5 KW with a 30-amp breaker will be required to sufficiently power the 30 amp service.

AIRSTREAM CLASSIC TRAILER OWNERS MANUAL

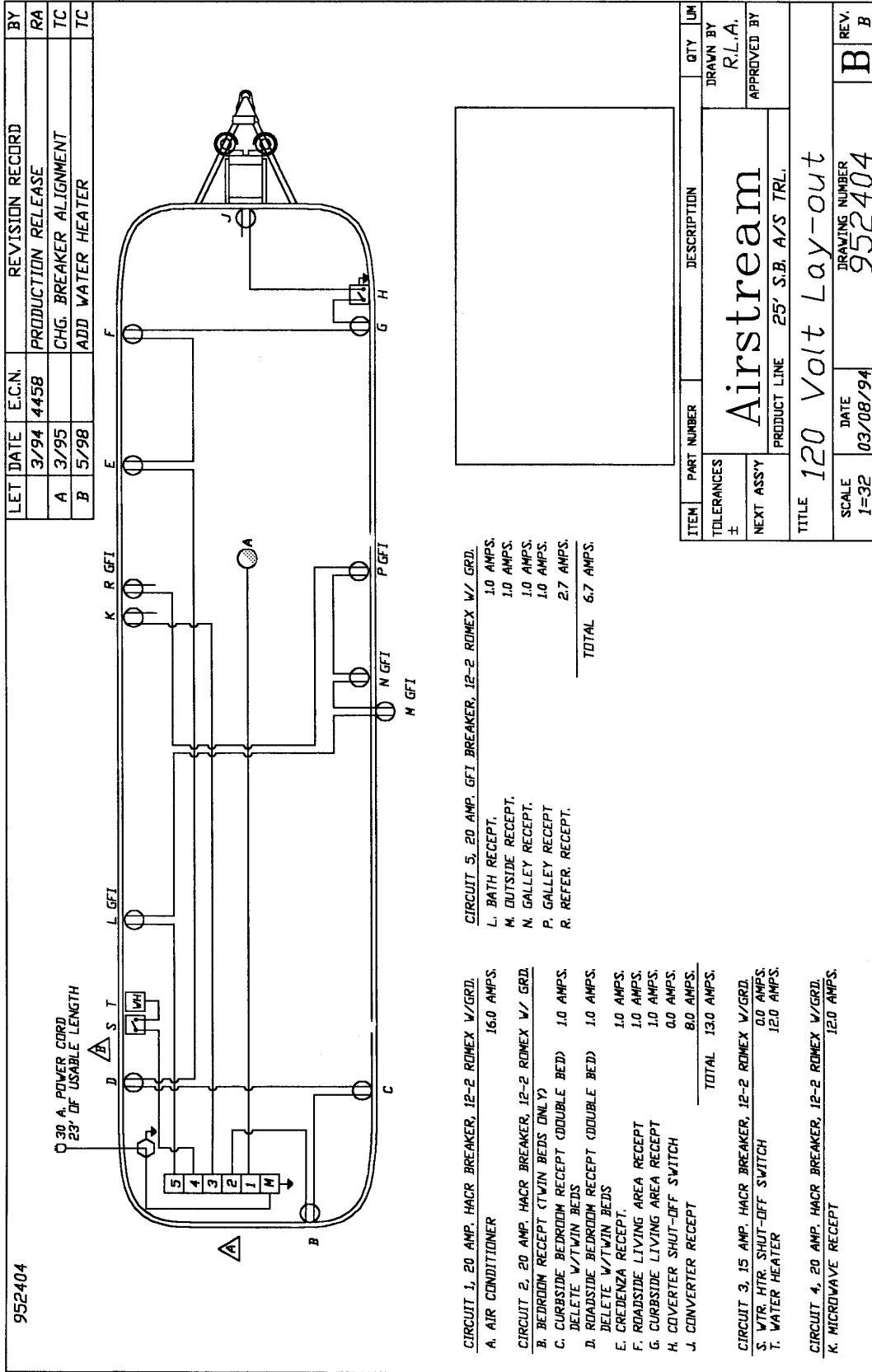

ITEM	PART NUMBER	DESCRIPTION	QTY	UM
Airstream				
PRODUCT LINE 25' S.B. A/S TRL.				
TITLE 120 Volt Lay-out				
TOLERANCES		DRAWN BY R.L.A.		
NEXT ASSY		APPROVED BY		
SCALE 1=32	DATE 03/08/94	DRAWING NUMBER 952404	REV. B	

AIRSTREAM CLASSIC TRAILER OWNERS MANUAL

952450

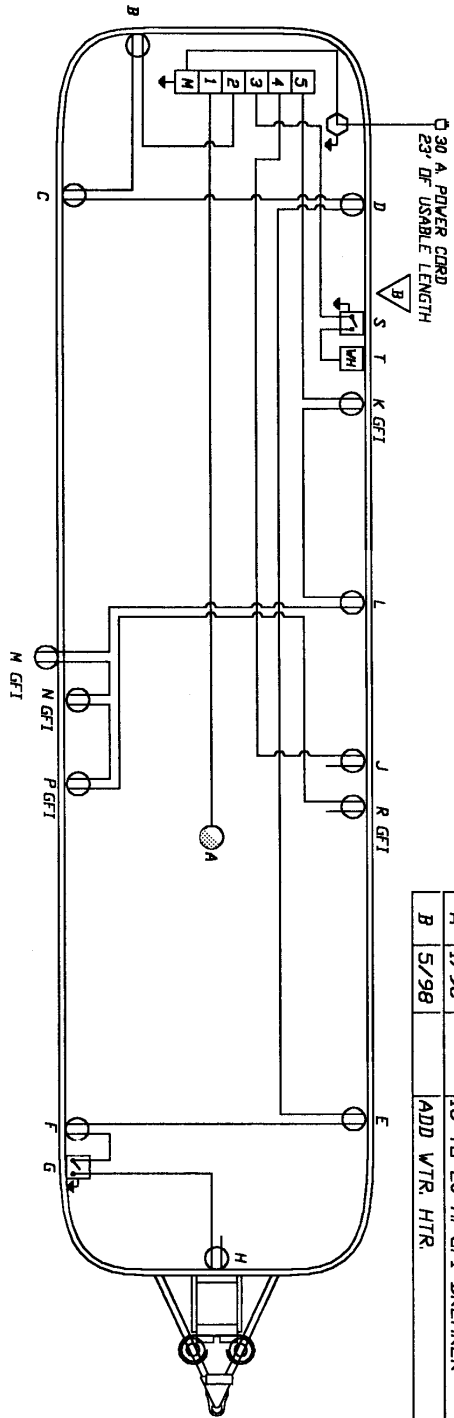

LET	DATE	E.C.N.	REVISION RECORD	BY
A	3/94	4458	PRODUCTION RELEASE	RA
B	5/98		ADD VTR. HTR.	TC

- CIRCUIT 1, 20 AMP, HACR BREAKER, 12-2 ROMEX W/GRD.**
- A. AIR CONDITIONER 16.0 AMPS.
 - B. BEDROOM RECEPT CTWIN BEDS (D/LY) 1.0 AMPS.
 - C. CURBSIDE BEDROOM RECEPT 1.0 AMPS.
 - D. ROADSIDE BEDROOM RECEPT 1.0 AMPS.
 - E. ROADSIDE LIVING AREA RECEPT 1.0 AMPS.
 - F. CURBSIDE LIVING AREA RECEPT 1.0 AMPS.
 - G. CONVERTER SHUT-OFF SWITCH 0.0 AMPS.
 - H. CONVERTER RECEPT 8.0 AMPS.
- TOTAL 13.0 AMPS.**

- CIRCUIT 2, 20 AMP, GFI BREAKER, 12-2 ROMEX W/ GRD.**
- K. BATH RECEPT 1.0 AMPS.
 - L. REFER RECEPT 2.7 AMPS.
 - M. OUTSIDE RECEPT 1.0 AMPS.
 - N. GALLEY RECEPT 1.0 AMPS.
 - P. GALLEY RECEPT 1.0 AMPS.
 - R. R.S. CREENZA RECEPT. 1.0 AMPS.
- TOTAL 7.7 AMPS.**

- CIRCUIT 3, 15 AMP, HACR BREAKER, 12-2 ROMEX W/GRD.**
- S. VTR. HTR SHUT-OFF SWITCH 0.0 AMPS.
 - T. WATER HEATER 12.0 AMPS.
- CIRCUIT 4, 20 AMP, HACR BREAKER, 12-2 ROMEX W/GRD.**
- J. MICROWAVE RECEPT 12.0 AMPS.

ITEM	PART NUMBER	DESCRIPTION	QTY	LM
Airstream				
PRODUCT LINE 28' S.B. A/S TRL.				
120 Volt Lay-out				
SCALE 1=32		DATE 03/08/94	DRAWING NUMBER 952450	
TOLERANCES ±		DRAWN BY T.C.		REV. B
NEXT ASSY		APPROVED BY		B

AIRSTREAM CLASSIC TRAILER OWNERS MANUAL

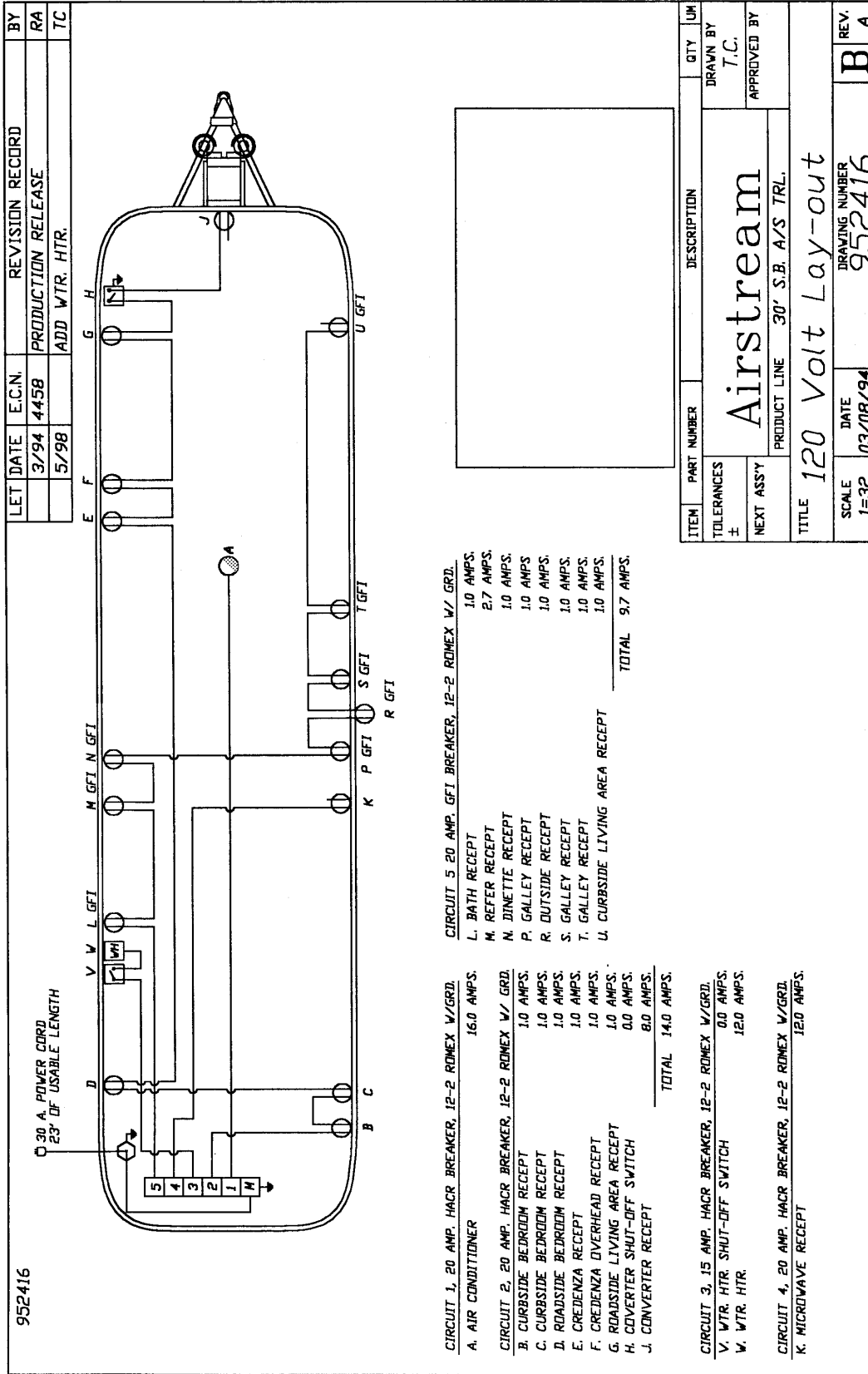

AIRSTREAM CLASSIC TRAILER OWNERS MANUAL

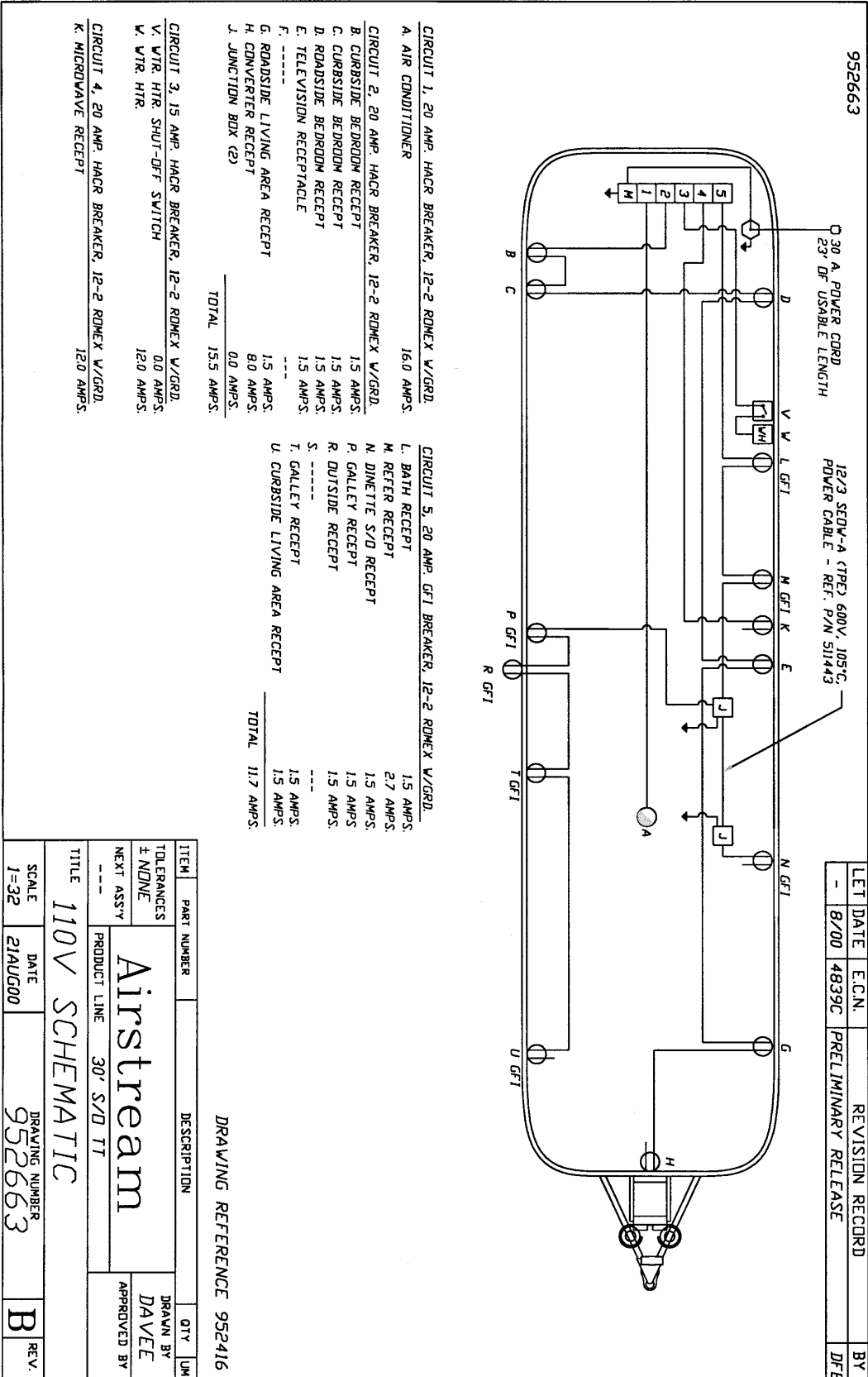

AIRSTREAM CLASSIC TRAILER OWNERS MANUAL

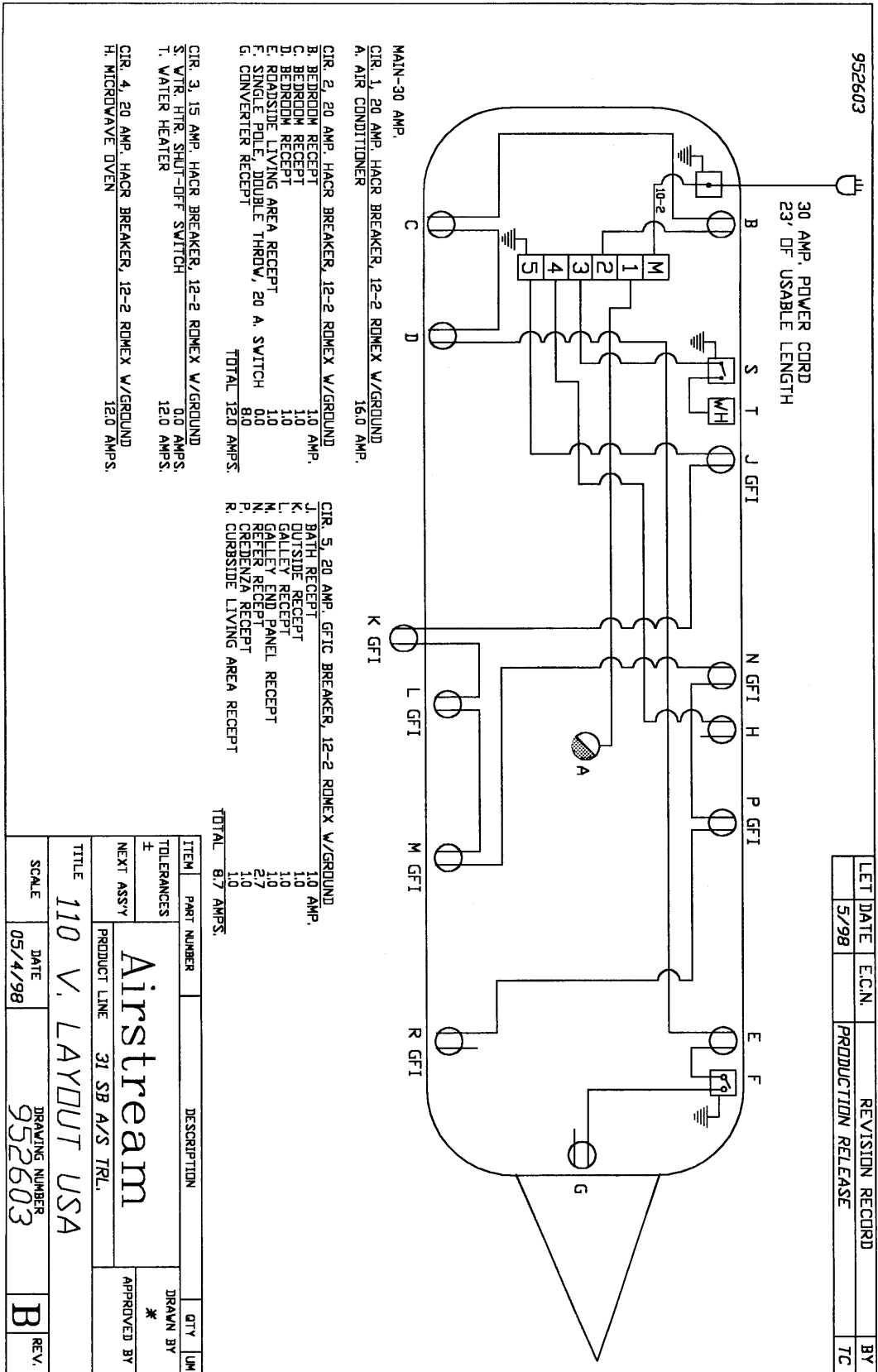

AIRSTREAM CLASSIC TRAILER OWNERS MANUAL

952408

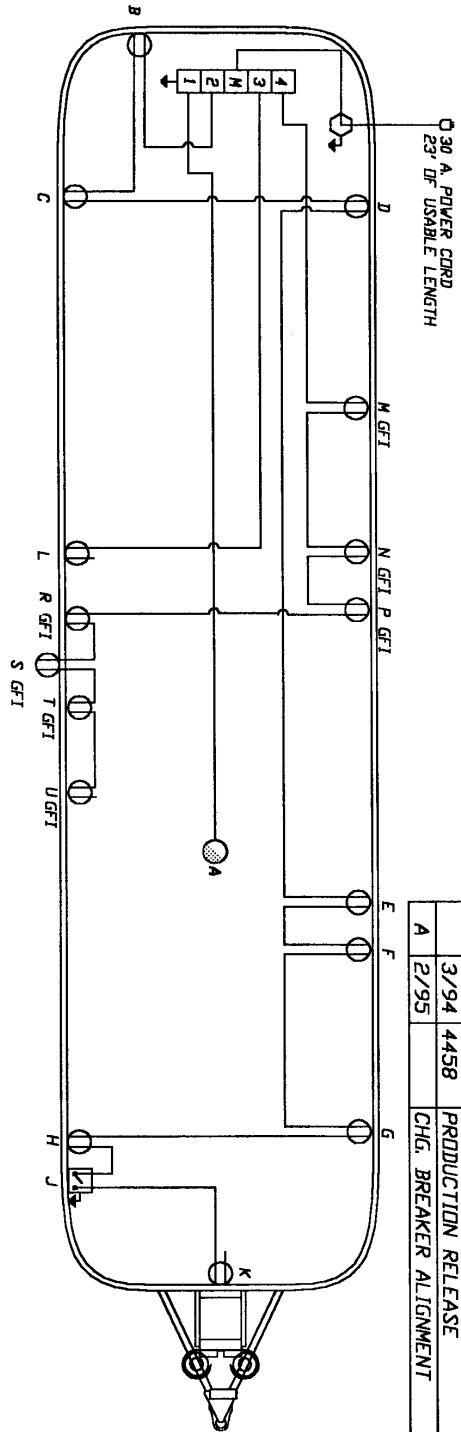

LET	DATE	E.C.N.	REVISION RECORD	BY
	3/94	4458	PRODUCTION RELEASE	RA
A	2/95		CHG. BREAKER ALIGNMENT	TC

- CIRCUIT 1, 20 AMP. HACR BREAKER, 12-2 ROMEX W/GRD.** 15.0 AMPS.
- A. AIR CONDITIONER**
- CIRCUIT 2, 20 AMP. HACR BREAKER, 12-2 ROMEX W/ GRD.** 1.0 AMPS.
- B. BEDROOM RECEPT (TWIN BEDS ONLY)**
- C. CURBSIDE BEDROOM RECEPT** 1.0 AMPS.
- D. ROADSIDE BEDROOM RECEPT** 1.0 AMPS.
- E. CREDEENZA RECEPT** 1.0 AMPS.
- F. ROADSIDE LIVING AREA RECEPT** 1.0 AMPS.
- G. CURBSIDE LIVING AREA RECEPT** 1.0 AMPS.
- H. CURBSIDE LIVING AREA RECEPT** 1.0 AMPS.
- J. CONVERTER SHUT-OFF SWITCH** 0.0 AMPS.
- K. CONVERTER RECEPT** 8.0 AMPS.
- TOTAL 15.0 AMPS.**

- CIRCUIT 4, 15 AMP. GFI BREAKER, 12-2 ROMEX W/ GRD.** 1.0 AMPS.
- M. BATH RECEPT**
- N. REFER RECEPT** 2.7 AMPS.
- P. DINETTE RECEPT** 1.0 AMPS.
- R. GALLEY RECEPT** 1.0 AMPS.
- S. OUTSIDE RECEPT** 1.0 AMPS.
- T. GALLEY RECEPT** 1.0 AMPS.
- U. GALLEY RECEPT** 1.0 AMPS.
- TOTAL 8.7 AMPS.**

CIRCUIT 3, 20 AMP. HACR BREAKER, 12-2 ROMEX W/GRD. 1.0 AMPS.

L. MICROWAVE RECEPT

ITEM	PART NUMBER	DESCRIPTION	QTY	UM
Airstream				
120 Volt Lay-out				
34' S.B. A/S TRL.				
DRAWING NUMBER			DRAWN BY	
952408			T.C.	
DATE			APPROVED BY	
03/08/94			B	
SCALE			REV.	
1=32			A	

AIRSTREAM CLASSIC TRAILER OWNERS MANUAL

APPLIANCES

AIR CONDITIONER

Manufacturer: Dometic Sales Corporation
2320 Industrial Parkway P.O. Box 490
Elkhart, IN 46515
Phone: 219-295-5228

Note: Review the air conditioning literature supplied in your Owner's Packet before proceeding,

The roof air conditioner used on Airstream trailers is one of the most popular on the market today. In your Owner's Packet is a set of literature covering all operating and maintenance instructions. If the literature is misplaced please contact the air conditioner manufacturer or your Airstream dealer for replacement.

The voltage to the air conditioner is critical. We commonly refer to 110 or 120 volts, but a check with a voltmeter may find voltage much lower. Your air conditioner will probably not function if the current drops below 105 volts. Low voltage is usually associated with older or poorly maintained trailer parks, but many people have found their homes, built only twenty or thirty years ago, may not be capable of operating the air conditioner on some receptacles. Parking your motorhome so the power cord can be plugged into a receptacle close to the fuse or circuit breaker box can alleviate the problem. Avoid extension cords and adapters whenever possible. If an extension cord must be used it should be as short and heavy as possible to provide the most current to the air conditioner.

If high temperatures are expected, you should make an effort to park in a shaded area. Starting the air conditioner early in the morning also helps. It is much easier to hold a comfortable temperature than it is to lower the temperature after the interior of the trailer is already hot.

AIRSTREAM CLASSIC TRAILER OWNERS MANUAL

FURNACE

Manufacturer: Hydro Flame Corporation 1874
South Pioneer Road
Salt Lake City, UT 84104
Phone: 801-972-4621

The manufacturer of the furnace in your motorhome is well known in the RV industry. The furnace burns LP gas, and is powered by 12 volt current from the battery or power converter when plugged into city power. Operating instructions are located in your Owners Packet. If they should become misplaced new literature can be ordered direct from the manufacturer or your Airstream dealer. The manufacturer also offers a detailed service guide for your furnace.



WARNING: Carefully read all the manufacturer's instructions prior to operating.
NEVER store flammable material next to the furnace.

If warranty service is required use only a service location recommended by the furnace manufacturer or your Airstream dealer.

AIRSTREAM CLASSIC TRAILER OWNERS MANUAL

RANGE

Manufacturer: Magic Chef
28812 Phillips Street
Elkhart, Indiana 46514
219-264-9578

People using gas ranges in their home will find little difference in the operation of the range in the motorhome. Other customers, used to electric ranges may be a little apprehensive at first; but will quickly gain confidence. The basic operation of the gas ranges have been the same for many years, but please be sure to read all the directions furnished by the manufacturer and located in the Owner' s Packet. Excellent service and parts manuals are available from the manufacturer.



WARNING: The operation manual for the range is titled "Maytag RV Cooking Appliances". If this has not been provided with your trailer, contact the manufacturer listed at the top of the page to obtain. Their manual contains specialized warnings and cautions that should be reviewed prior to operating the appliance.

AIRSTREAM CLASSIC TRAILER OWNERS MANUAL

MICROWAVE OVENS

Only federally certified technicians are permitted to service microwave ovens. For this reason the only service instructions contained in this manual are for removal of the complete oven. If you have a microwave oven problem please contact the appropriate manufacturer, an authorized Airstream dealer, or the Factory Customer Service Department.

Dometic Sales Corporation
2320 Industrial Parkway
P.O. Box 490
Elkhart, IN 46515
219-295-5228

Sharp Electronics Corporation
10 Sharp Plaza
Paramus, New Jersey 07652
201-5112-0055

Both microwave ovens can be removed for service by removing the screws in the vented trim ring. The trim rings are fastened to microwave oven. After removing the screws, pull straight out on the oven until the 110-volt plug can be unplugged.

AIRSTREAM CLASSIC TRAILER OWNERS MANUAL

REFRIGERATOR

Manufacturer:

Dometic Sales Corporation 2320
Industrial Parkway P.O. Box 490
Elkhart, Indiana 46514
Phone: 219-295-5228

Review all Dometic Literature supplied in your Owner's Packet or stored in the refrigerator prior to operating.

In an absorption refrigerant system ammonia is liquefied in the finned condenser coil at the top rear of the refrigerator. The liquid ammonia then flows into the evaporator (inside the freezer section) and is exposed to a circulating flow of hydrogen gas, which causes the ammonia to evaporate, creating a cold condition in the freezer.

The tubing in the evaporator section is specifically sloped to provide a continuous movement of liquid ammonia, flowing downward by gravity, through this section. If the refrigerator is operated out-of-level when the vehicle is not moving, liquid ammonia will accumulate in portions of the evaporator tubing. This will slow the circulation of hydrogen and ammonia gas, or in severe cases, completely block it, resulting in a loss of cooling.

Any time the vehicle is parked for several hours with the refrigerator operating the vehicle should be leveled to prevent this loss of cooling. The vehicle needs to be leveled only so it is **comfortable to live in** (no noticeable sloping of floor or walls).

When the vehicle is moving the leveling is not critical, as the rolling and pitching movement of the vehicle will pass to either side of level, keeping the liquid ammonia from accumulating in the evaporator tubing.

OPERATION

The refrigerator requires 12-volt current to operate even if running on LP or 110 volt modes. The 12-volt is used to power the circuit board that directs the refrigerator functions. When running in a mode such as LP, it means the heat source, by far the largest power requirement; to evaporate the ammonia is being provided by an LP Gas burner.



WARNING: Most LP gas appliances used in recreational vehicles are vented to the outside of the vehicle. When parked close to a gasoline pump, it is possible that gasoline fumes could enter this type of appliance and ignite the burner flame, CAUSING A FIRE OR AN EXPLOSION.

AIRSTREAM CLASSIC TRAILER OWNERS MANUAL

WATER HEATER

Manufacturer:

Atwood Mobile Products 4750
Hiawatha Drive P.O. Box 1205
Rockford, Illinois 61105
Phone: 815-877-7461

Note: Review the water heater literature supplied in your Owner's Packet before proceeding.



WARNING: Hydrogen gas can be produced in a hot water system served by this heater that has not been used for a long period of time (generally two weeks or more). Hydrogen gas is extremely flammable. To reduce the risk of injury under these conditions, it is recommended that the hot water faucet be opened for several minutes at the kitchen sink before using any electrical appliance connected to the hot water system. If hydrogen is present there will probably be an unusual sound such as air escaping through the pipe as the water begins to flow. There should be no smoking or open flame near the faucet at the time it is open.

Electronic Ignition

The switches used to light your electronic ignition water heater are located in the bathroom above the lavatory top. When the gas switch is turned on, the red light will come on indicating the "try" mode is in effect. Normally the burner will ignite in just a few seconds, and the light will go out. If your LP system hasn't been used for some time, the system may go into safety lockout (about 20 seconds) before the air is all expelled from the lines. Turning the switch off for 30 seconds, then back on, reinstates the "try" mode.

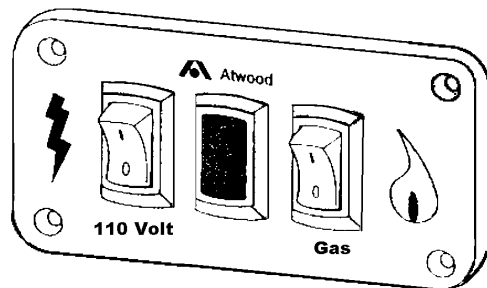

A second switch for the water heater is also located on the panel. This provides power to the heating element. DO NOT use unless you are sure the water heater is full. (Open a faucet and see if there is a full stream of water on the hot side)

The 110-volt element may be operated at the same time as the gas burner. To operate the 110-volt by itself simply turn the electronic gas igniter switch off.

The heating element is 1500 watts so if breakers start to kick out when the air conditioner cycles you may want to turn the switch off to the heating element.

SAFETY

If your water system is full and cold and the water heater is ignited the system can see pressures as high as 120 psi before the relief valve starts to open. Since the water system normally operates in the 40-psi range the water expanding does put unusual stress on the system. This normally does not cause any problems, but the stress is easily alleviated. As the water is heating just open any faucet and run as little as a cup of water. Just removing this small amount of water reduces the pressure build up significantly.

For fun, watch the sequence of events your family goes through when you park the trailer **and ignite the water heater. More than likely someone will run water and relieve the pressure without even realizing it.**

AIRSTREAM CLASSIC TRAILER OWNERS MANUAL

HIGH VOLUME ROOF VENT (OPTIONAL)

Manufacturer: FAN-TASTIC VENT CORP. 4349 S. Dort Hwy.
Burton, MI 48529
1-313-742-0330
1-800-521-0298

The optional High-volume roof vent system is designed to quickly exhaust stale, hot air and draw in fresh air. It's great to use when the outside temperature really doesn't call for air conditioning, but heat has built up in your coach.

OPERATING INSTRUCTIONS:

- 1) Open dome approx. 3" or more (ceiling fan has a built in safety switch that will not allow motor to operate unless dome is partially open).
- 2) Turn 3- speed knob to desired performance lever (3-Low, 2-Medium, 1-High, O-Off)
- 3) Open a window or door for airflow,
- 4) Source of airflow is determined by the window(s) or door(s) opened. For best results, close all roof vents and open 1 (one) window the greatest distance from your Fan-Tastic Vent ceiling fan,

CAUTION: Never place Lindeen™ or a like cover over ceiling fan. Greatly restricted airflow & increased sound levels will occur.

WHEN EQUIPPED WITH REVERSE SWITCH

- 1) Turn fan motor off by:
 - a) Setting 3-speed switch to "O" - OFF.
 - b) Closing Dome.
 - c) Selecting center position on IN/OUT rocker switch
- 2) Wait for fan blade to stop.
- 3) Select IN position, brings air from the roof area into your coach (pressurizes inside).
- 4) Or select OUT position, brings air in through any or all openings in coach and exhausts through the roof.
- 5) Turn fan motor On.

WHEN EQUIPPED WITH THERMOSTAT:

- 1) Follow "Operating Instructions: 1 thru 4
- 2) Select desired temperature or comfort level on thermostat. Fan motor will now start & stop automatically as interior temperature of coach exceeds or drops below selected level.

NOTE: Fan motor will not start if temperature selected is warmer than interior temperature of coach.

CLEANING INSTRUCTIONS:

- 1) Turn fan motor Off.
- 2) Remove 8 painted flathead Phillips screws around perimeter of screen insert only.
- 3) Clean screen with soap & water solution and reinstall.

AIRSTREAM CLASSIC TRAILER OWNERS MANUAL

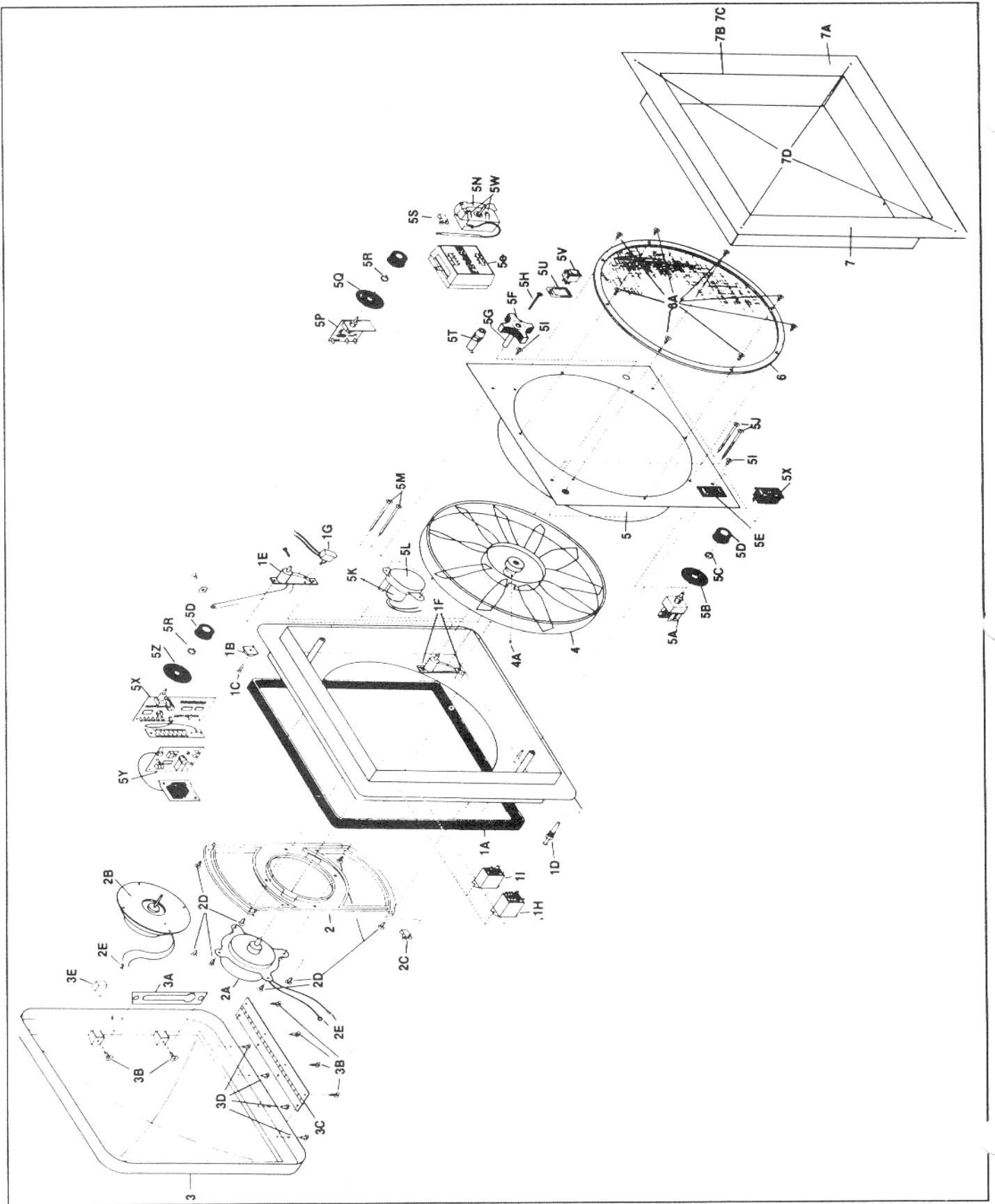

AIRSTREAM CLASSIC TRAILER OWNERS MANUAL

	#1	#1010-81 MAIN BASE
(4.5)	#1	#1144-09 EPDM BULB SEAL
	#1B	#1024-81 ALIGNMENT SPACER
	#1C	#1025-05 #8 x 5/8 F.H. PH. t/s ZINC
	#1D	#1122-05 JAMB SWITCH #9251 - C.H.
	#1E	#2011-05 6" LIFT ARM -w/RIV. & BUSHING
(2)	#1F	#1012-05 #10 x 1/2" P.H. PH. p/s - ZINC
(2)	#1G	#2053-09 P-267T-IA-RD CARLING LIMIT
	#1H	#2052-00 LYZF - DC - 12 - OMRON
	#11	#9002-09 G4W -1 1123 - 95 - TVB - DC - 12 OMRON
	#2	#1015-00 "H" MOTOR MOUNT
	#2A	#4017-09 MOTOR - PM3491x - BLK - 1600 RPM
	#2B	#1017-03 MOTOR-#31153-140ORPM-CSA
	#2C	#1019-81 HEYCO - CCL 1/8 - #3302 CLAMP
(8)	#2D	#1016-05 #8 x 1/2 P.H. PH. t/s -ZINC
	#2E	#1121-05 B3R - 56 - RING CONNECTOR
	#3	#1020-19 DOME-SMOKE
(6)	#3A	#1023-05 DOME SLIDE - GALVANIZED
	#3B	#1016-05 #8 x 1/2 P.H. PH. t/s - ZINC
	#3C	#1021-05 #1260A - HINGE - ALUMINUM
	#3D	#1022-05 5/32 x 1/4 x 5/16 "o" RIVET ZINC
	#3E	#2018-81 DOME WEDGE - WHITE NYLON
	#4	#1138-00 FAN BLADE - 12" CLR.
	#4A	FAN BLADE SET SCREW
	#5	#1030- SCREEN ASSEMBLY COLORED
	#5A	#1031-05 3-SPEED SWITCH #3K754
	#5B	#1033-09 DIAL LABEL - BLK. POLY
	#5C	#1032-05 NUT - 7/16 x 28 UNEF - ZINC
	#5D	#1034-09 KNOB - SOFT TOUCH #PT-6-P
	#5E	#9001-09 DPDT - HOT STAMPED w/CROSS KNOB
	#5F	#1140-09 1741Z - BLACK
	#5G	#2143-05 EXTENSION 1 1/8 - ZINC
	#5H	#1142-05 8-32 x 1 3/4 P.H. PH. m/s ZINC
(2)	#5I	#1038-#88 x 3/8" F.H. PH t/s - COLOR
(2)	#5J	#1039-#8 x 2 3/4" F.H. PH. w/s - COLOR
	#5K	#6050-05 DOME LIFT MOTOR - #200.0262A
	#5L	#6035-MOTOR CAP - COLORED
(2)	#5M	#1039-#8 x 2 3/4 F.1-1. PH. w/s - COLOR
	#5N	#9006-05 BT THERMO #3301B
	#5P	#9015-90 SST THERMO #00-00127-000
	#5Q	#9009-09 LABEL-COOLER-BLACK
	#5R	#1032-05 NUT - 7/16 x 28 UNEF- ZINC
	#5S	#1018-81 BT CLAMP - CCL 1/4 - #3304
	#5T	#9017-00 FUSE #312010 - 10A - FLTW*
	#5T	#9018-09 FUSE HOLDER #345602 - FLTW*
	#5U	LABEL OVERRIDE/NORMAL
	#5V	B-2-1 8 GOLD - SPST-SGMA
(2)	#5W	#9008-05 6 - 32 x 1/4 F. H. PH. m/s - ZINC
	#5X	SPSTw/ON/OFF LABEL
	#5e-	#9005-39 RBT. SHW w/OFF WALL THERMO
	#6	#1035-SCREEN RING w/ALUM. WIRE - COLOR
(8)	#6A	#1038-8B x 3/8" F.H. PH. t/s -COLORED
	#7	#1040-INTERIOR GARNISH - 3" MAX. - COLOR
	#7A	#9024-81 INTERIOR GARNISH - 4" MAX. - COLOR
	#7B	#9019-00 OAK STYLE - FINISHED
	#7C	#9020-00 OAK RETURN PANEL - ANY SIZE
	#7D	#9010-#6 x 3/4 F.H. PH. t/s - COLORED

NOTES

AIRSTREAM CLASSIC TRAILER OWNERS MANUAL

SPECIFICATIONS

Note: All weights were made on prototype vehicles. Your production trailer may vary. For the weight specifications of your trailer read the weight label and check the manufacturing tag on the side of your trailer. For label location, see information under "Loading" section of this manual

MODEL	25'	28'	30'	31'	34'	30' S/O	30' S/O CSA	34' S/O Lounge	34' S/O Lounge CSA	34' S/O Dinette	34' S/O CSA Dinette
Exterior Length	25'9"	29'	31'	31'	34'10"	31'	31'	34'10"	34'10"	34'10"	34'10"
Exterior Width	8'5½"	8'5½"	8'5½"	8'5½"	8'5½"	8'5½"*	8'5½"*	8'5½"*	8'5½"*	8'5½"*	8'5½"*
Interior Width	8'1"	8'1"	8'1"	8'1"	8'1"	8'1"	8'1"	8'1"	8'1"	8'1"	8'1"
Exterior Height W / AC	9'7½"	9'7½"	9'7½"	9'7½"	9'7½"	9'7½"	9'7½"	9'7½"	9'7½"	9'7½"	9'7½"
Interior Height W / AC	6'3½"	6'3½"	6'3½"	6'3½"	6'3½"	6'3½"	6'3½"	6'3½"	6'3½"	6'3½"	6'3½"
*Hitch Ball Height	18 ¾"	18 ¾"	18 ¾"	18 ¾"	18 ¾"	18 ¾"	18 ¾"	18 ¾"	19 ¾"	18 ¾"	19 ¾"
Tire Size	ST225/ 75R15	ST225/ 75R15	ST225/ 75R15	ST225/ 75R15	ST225/7 5R15	ST225/ 75R15	ST225/ 75R15	ST225/ 75R15	ST225/ 75R15	ST225/ 75R15	ST225/ 75R15
Fresh water (gal.)	54	54	54	54	54	54	54	54	54	54	54
Gray water (gal.)	39	37	37	37	37	37	37	37	37	37	37
Hitch Weight (lbs.)	870	730	730	890	820	1,125	1,125	1,490	1,490	1,250	1,250
GVWR (lbs.)	7,300	8,600	8,700	8,700	9,800	9,100	10,300	10,500	11,500	10,500	11,500
NCC	1,250	1,815	1,470	820	1,730	1,233	2,423	1,740	2,740	1,478	2,478
UBW (lbs.)	6,050	6,785	7,230	7,880	8,070	7,877	7,877	8,760	8,760	9,022	8,890

The Unit Base Weight (UBW) and the Net Carrying Capacity (NCC) is not the same as the Unloaded Vehicle Weight (UVW) and the Cargo Carrying Capacity (CCC) shown on the Trailer Weight Information tag in your vehicle. The UBW and NCC weights are for the base unit with no options and fluids except for fuel on motorhomes. The UVW and CCC on the Trailer Weight Information tag are weights for the individual vehicle as built with its options and certain water capacities.

*10'1 ½" with slide extended.

Gross Vehicular Weight Rating (GVWR): is the maximum permissible weight of this trailer when fully loaded. It includes all weight at the trailer axle (s) and tongue or pin.

Unit Base weight (UBW): is the dry weight of the base unit with bedroom group and w/o options or fluids.

Net Carrying Capacity (NCC): is equal to GVWR-UBW.

Gross Axle Weight Rating (GAWR): is the value specified as the load carrying capacity of a single axle system, as measured at the tire-ground interfaces.

Continued

AIRSTREAM CLASSIC TRAILER OWNERS MANUAL

SPECIFICATIONS

Alignment: Toe In 0 - 1/8" (All Models)
Camber 0 - 1 1/2 ° positive (All Models)

Battery 12 Volt Deep cycle (All Models)

Tire Inflation (PSI) Cold ST225/75R15 LRD 65 psi

*Hitch Ball Height

The proper height will vary according to the weight you carry and the tires you use. However, checking the height on your trailer is relatively easy:

1. With trailer on fairly level ground measure from ground to bottom of frame, front and rear.
2. Adjust front jack until measurements are equal
3. Now measure from ground to the inside top of ball coupler. This figure is the hitch height. The hitch ball is then usually set 1/2" to 1" higher, according to the spring weight of your tow vehicle, to allow for it to settle when the trailer is hitched up.