

AIRSTREAM INTERNATIONAL TRAILER OWNERS MANUAL 2003

INTRODUCTION

The Owners Manual for your new Airstream trailer is designed to respond to the most frequent inquiries regarding the operation, function and care of the many systems that make modern trailering a joy.

Airstream realizes our customers possess varying degrees of expertise in the area of repairing and maintaining the appliances in their trailer. For this reason, the service and trouble-shooting information found in this manual is directed toward those with average mechanical skills. We also realize you may be more familiar in one area than you are in another. Only you know your capabilities and limitations.

We want you to use this manual, and hope you will find the information contained in it useful, however, should you ever feel you may be "getting in over your head" please see your dealer to have the repairs made.

A brief explanation of the operation of the appliances such as refrigerator, furnace, water heater and others are explained in this manual. However, you will also find the manufacturer's information supplied in a packet included with this manual.

All information, illustrations and specifications contained in the literature are based on the latest product information available at the time of publication approval.

Throughout this manual **CAUTION** and  **WARNING** notations are used.

Failure to observe **CAUTION** can damage equipment.

 **WARNING** notes the possibility of personal and/or fatal injury if not observed.

Note: If and when new materials and production techniques are developed which can improve the quality of its product, or material substitutions are necessary due to availability, Airstream reserves the right to make such changes.

The next page of this manual is a table of contents. Point your cursor to the subject, [colored blue](#), you would like to research. Right click your mouse while it is on the subject title and you will be taken to that area of the manual.

To get back to table of contents, click on the back arrow in the tool bar at the top of the document. The arrow will be lighted.

The next two pages contain an index of subject material in alphabetical order.

AIRSTREAM INTERNATIONAL TRAILER OWNERS MANUAL 2003

A. WARRANTY AND SERVICE

[Warranty](#)
[Warranty Explanation](#)
[Service](#)
[Reporting Safety Defects](#)
[Maintenance Schedule](#)
[Maintenance Parts & Supplies](#)

B. TOWING

[Tow Vehicles](#)
[Brakes](#)
[Loading](#)
[Weighing your Trailer](#)
[Hitching Up](#)
[Towing Tips](#)
[Pre-Travel Check List](#)

C. CAMPING

[Camping Safety](#)
[Overnight Stop](#)
[Extended Stay](#)
[Leveling & Stabilizing](#)
[Hook Ups](#)
[Winter Traveling](#)

D. EXTERIOR

[Cleaning](#)
[Chassis](#)
[Windows & Screens](#)
[Power Jack](#)
[Tires](#)
[Axle and Running Gear](#)
[Electric Brakes](#)

E. INTERIOR FURNISHINGS AND ACCESSORIES

[Fabric Care](#)
[Flooring & Fixtures](#)
[Central Control Panel](#)
[Features & Switches](#)
[Storage Areas](#)
[Smoke Alarm](#)
[LP Gas Detector](#)
[Fire Extinguisher](#)

F. PLUMBING

[LP \(Liquid Petroleum\) Gas](#)
[Water](#)
[Water Pump](#)
[Drainage](#)
[Winterizing](#)
[Drain and Waste](#)
[Toilet](#)

G. ELECTRICAL

[12-volt Operation](#)
[Battery](#)
[Converter](#)
[TV Antenna](#)
[Satellite Antenna](#)
[Solar Panel](#)
[Bathroom Exhaust](#)
[Monitor Panel](#)
[110-Volt System & Components](#)

H. APPLIANCES

[Air Conditioner](#)
[Furnace](#)
[Range/Oven](#)
[Refrigerator](#)
[Water Heater](#)
[Roof Vent, High Volume](#)

I. SPECIFICATIONS

AIRSTREAM INTERNATIONAL TRAILER OWNERS MANUAL

INDEX

- Accessories.....B-13
- Air Conditioner.....H-1
- Alignment.....A-4, D-8, I-2
- Antennas.....G-18, G-21
- Appliances.....H-1
- Axles.....D-8
- Awning.....D-2

- Backing.....B-11
- Battery.....E-3, G-2, I-2
- Battery Disconnect.....E-4, G-1, G-29
- Bath Exhaust.....E-3, G-23
- Bathroom.....E-3
- Bearing.....D-8, D-10
- Bottles, LP.....F-2
- Brake Controller.....B-9, D-12
- Brakes.....B-1, D-12
- Breakaway Switch.....B-2, D-12
- Bulbs.....A-8, G-3

- Camping.....C-1
- Carpet.....E-2
- Capacities.....I-1
- Cargo.....B-4, E-4
- Caution.....Introduction
- Chassis.....D-3
- Check List.....B-12
- City Water Hook-Up.....C-4, F-12
- Cleaning.....D-1
- Circuit Breakers.....G-4, G-11, G-29, G-34
- Coaxial Cable Wiring.....G-9
- Condensation.....C-6
- Converter.....G-3, G-29
- Connector
 - 7-Way.....B-2, G-9
 - 110-volt.....C-4, G-29
- Countertop.....E-2
- Coupler.....D-3
- Curtains.....E-1
- Control Panel.....E-3, G-24

- Dimensions.....I-1
- Dinette.....E-2
- Doors
 - Main.....D-2
 - Screen.....D-2
- Drain Valves.....F-17
- Drainage.....F-17
- Drapes.....E-1
- Dump Valves.....F-21

- Electrical.....G-1
 - 12 Volt.....G-1
 - 110 Volt.....C-4, G-29
 - Circuit Breakers.....G-4, G-11, G-29, G-34
 - Diagrams
 - 12 Volt.....G-4
 - 110 Volt.....G-29
 - 7-Way Cable.....B-2, G-9
 - Power Cord.....C-4, G-29
 - Trouble Shooting.....G-6
- Escape Window.....C-1, C-5, D-2, E-9
- Exhaust Fans.....E-3, F-4, G-23, H-6
- Extended Stay.....C-3
- Exterior Maintenance.....D-1

- Factory Service.....A-5
- Fans.....E-4, G-11, F-4, H-6
- Faucets.....F-13
- Fill Valves.....F-1
- Filter, Water.....F-10
- Fire Extinguisher.....E-9
- Flat Tire.....C-3, D-7
- Furnace.....H-2
- Fuses.....A-8, G-1, G-4, G-10

- Galley.....E-2
- Gas, LP.....C-4, E-8, F-1
- Gas Regulator.....F-2
- Grey Tank (Aux).....F-2, I-1
- Ground Fault Interrupter.....G-30
- Grounding.....G-29
- GVWR.....B-4, I-1
- GAWR.....B-5

- Hitch.....B-6, I-2
- Hitching Up.....B-6
- Hitch Weight.....B-5, I-1
- Holding Tanks.....F-2
- Hitch Ball Height.....B-7, D-3, I-1
- Humidity.....C-7

- Interior.....E-1

- Jacks.....C-3
 - Stabilizing.....C-2
 - Tire Changing.....C-3, D-7

AIRSTREAM INTERNATIONAL TRAILER OWNERS MANUAL

Lavatory	E-2	Table	E-2
Length, Trailer.....	I-1	Tires	D-7, I-1
Leveling.....	C-3	Tongue Latch.....	D-3
Lights	E-3, G-9, G-11	Tongue Weight	B-5
Loading	B-4, E-4	Toilet	F-24
Lounge	E-2	Towing	B-1, B-9
LP Bottles.....	F-2	Tow Car.....	B-1, B-6
LP Gas	C-7, E-8, F-1	TV	C-5
LP Gas Detector	E-8	TV Antenna	G-18
Maintenance Parts	A-8	Upholstery	E-1
Maintenance Record.....	A-9	Valves, Drain.....	F-17
Maintenance Schedule.....	A-6	Vents	E-4, H-6
Monitor Panel.....	E-3, F-12	Warning	Introduction
Oven	H-3	Warranty	A-1
Overnight Stop	C-2	Washing.....	D-1
Parking	C-2	Waste System	F-21
Passing	B-10	Water System.....	F-6
Plumbing	F-1	Drainage	F-17
Power Cord.....	C-4, G-29	Filter	F-6
Power Jack.....	D-3	Heater	E-4, F-11, H-6
Range	H-3	Inlet Connection	C-4, F-12
Refrigerator	H-4	Pump	F-19, G-25
Regulator, LP	F-2	Strainer	F-6
Roof Vents.....	E-3, H-6, F-4	Tank.....	F-6, F-17, I-1
Rotation, Tire.....	D-9	Valves	F-17, F-19
Safety	A-5, C-1, E-5, E-8, E-9, F-3	Waxing	D-1
Safety Chains.....	B-8	Weight	B-4, F-1
Sanitizing.....	F-11	Weight Distribution	B-6
Screens	D-2, E-9	Wheel	
Service	A-5	Torque.....	D-7
7-Way Conn	B-2, G-9	Alignment.....	D-10, I-1
Sewer Hose.....	C-4, F-21	Bearing	D-10
Shower	E-2	Windows.....	D-2, E-9
Sink	E-2	Winter Traveling.....	C-6
Smoke Alarm.....	E-5	Winterizing.....	F-18
Solar Panel.....	G-22	Wiring	See Electrical
Specifications	I-1		
Stabilizing.....	C-3		
Step	B-8, D-2		
Storage	E-4, F-18		
Stove	H-3		
Suspension.....	D-10		

AIRSTREAM INTERNATIONAL TRAILER OWNERS MANUAL

WARRANTY COVERAGE

When you buy a new Airstream Travel Trailer from an authorized Airstream dealer, Airstream, Inc., warrants the trailer from defects in material and workmanship as follows:

BASIC WARRANTY PERIOD

This warranty extends for a period of two years from the date of original retail purchase.

ITEMS COVERED

Any part of the trailer or any component equipment installed by the factory is covered by the basic warranty *except* the following items, which are *not covered*:

- Tires
- Batteries

The tire and battery warranties will be handled by their respective service points and according to their written policy. This limited warranty does not include failure caused by accident, abuses, normal wear, overload or any cause not attributable to a defect in original material or workmanship of the trailer or component equipment as installed by the factory.

LIMITATION OF IMPLIED WARRANTIES

All warranties of merchantability and fitness for a particular purpose, whether written or oral, expressed or implied, shall extend only for a period of two years from the date of original purchase. There are no other warranties, which extend beyond those described on the face hereof and which expressly excludes conditions resulting from normal wear, accident, abuse, exposure or overload. Some states do not allow limitation on how long an implied warranty lasts, so the above limitations may not apply to you.

AIRSTREAM'S RESPONSIBILITY

The basic **Airstream Limited Warranty** applies for a period of two years from the date of original purchase, and the application date of all warranties is that indicated on the owner's identification card. Defects in items covered under this Warranty will be corrected without cost upon the return, at the owner's expense, of the trailer or defective part to an authorized Airstream dealer.

AIRSTREAM INTERNATIONAL TRAILER OWNERS MANUAL

CARE AND MAINTENANCE

This warranty covers only defective material and/or workmanship; adjustments are made at the factory prior to shipment, and rechecked by the dealer prior to delivery to the customer. Adjustments thereafter become a customer responsibility.

Each Airstream exterior (not including the underside) is clear coated to prevent oxidation. This application is covered by a two-year warranty against peeling. Prolonged exposure to salt air or industrial fall-out will permit penetration through the coating material, causing damage to the exterior finish. Since Airstream, Inc., has no control over these conditions, it is necessary for the owner to wash and maintain their trailer as instructed in the Owner's Manual.

The owner is also responsible for following all recommendations, instructions and precautions contained in the Airstream Trailer Owner's Manual and the individual manuals furnished by the chassis, appliance and other manufacturers.

INSTALLATIONS NOT COVERED

Airstream, Inc., does not accept any responsibility in connection with any of its trailers for additional equipment or accessories installed at any dealership or other place of business, or by any other party. Such installation of equipment or accessories by any other party will not be covered by the terms of this warranty.

IF REPAIRS ARE NEEDED

If your trailer needs repairs under the terms of the basic Airstream Limited Warranty, you should:

1. Take your trailer to your selling dealer or other Authorized Airstream Dealer.
2. If the dealer is incapable of making the repair, request that he contact the Service Administration Department at Airstream, Inc., for technical assistance.
3. If repairs are still not made, the customer should contact:

AIRSTREAM, INC.

419 W. Pike Street - P.O. Box 629
Jackson Center, Ohio 45334-0629
Attention: Owner Relations Department

Furnish the following information:

- The complete serial number of the trailer
- Mileage
- Date of original purchase
- Selling dealer
- Nature of service problem and steps or service, which have been performed. (The owner may be directed to another dealer at the owner's expense.)

4. If, after taking the above steps, repairs are still not complete, the Airstream owner may request the trailer be brought to the Factory Service Center at the owner's expense.

AIRSTREAM INTERNATIONAL TRAILER OWNERS MANUAL

DEALER REPRESENTATION EXCLUDED

The full extent of the basic **Airstream Limited Warranty** is set forth in detail in the folder, and in the explanation of the basic **Airstream Limited Warranty** covered in the Airstream Trailer Owner's Manual. Airstream Inc. will not be responsible for additional representations or implied warranties made by any of its dealers to the extent those representations are not a part of, or are contrary to, the terms and conditions of the basic Airstream Limited Warranty.

CONSEQUENTIAL AND INCIDENTAL DAMAGES

Airstream, Inc., will not be responsible for any consequential or incidental expenses or damages resulting from a defect. Incidental expenses include, but are not limited to: travel expenses, gasoline, oil, lodging, meals, telephone tolls, and loss of work and loss of use of the trailer. Some examples of consequential damages would be: stained curtains due to rain leaks or delaminated floor caused by a plumbing leak. Some states do not allow the exclusion or limitation of incidental or consequential damages, so the above limitation or exclusion may not apply to you.

WARRANTY TRANSFER

The basic **Airstream Limited Warranty** is transferable to subsequent owners for the duration of the warranty period. Warranty transfer application forms are available from your dealer or the Airstream Inc. Service Administration Department.

CHANGES IN DESIGN

Airstream Inc. reserves the right to make changes in design and improvements upon its product without imposing my obligation upon itself to install the same upon its products theretofore manufactured.

This warranty gives you specific legal rights, and you may also have other rights, which vary from state to state.

AIRSTREAM INTERNATIONAL TRAILER OWNERS MANUAL

EXPLANATION OF AIRSTREAM LIMITED WARRANTY

The Airstream Limited Warranty is detailed in a separate folder. A plastic WARRANTY IDENTIFICATION CARD is sent to you after Airstream receives notification from your dealer of the sale. Since this I.D. card is necessary to obtain warranty, it should be kept in the trailer or on your person during the warranty period.

EXCLUSIONS:

Normal Wear

Items such as tires, water purifier packs, curtains, upholstery, floor coverings, window, door and vent seals will show wear or may even wear out within the two year warranty period depending upon the amount of usage, weather, and atmospheric conditions.

Accident

We strongly urge our dealers and customers to inspect the trailer upon receipt of delivery for any damage caused by accident while being delivered to the dealer, or while it is on the dealer's lot. Damage of this nature becomes the dealer or customer's responsibility upon acceptance of delivery, unless Airstream is notified and the person making the delivery verifies the damage. Glass breakage, whether obviously struck or mysterious, is always accidental and covered by most insurance policies.

Abuse

Lack of customer care and/or improper maintenance will result in early failure for which Airstream cannot be held responsible.

Exposure

Not unlike a car, the steel parts of a trailer can and will rust if subjected to prolonged exposure to moisture, salt air, or corrosive air-borne pollutants without repainting. Aluminum oxidizes when unprotected under similar conditions, and refinery chemicals of a sulfurous nature are harmful to finishes if not washed off periodically. Extremely hot or direct sunlight will deteriorate rubber and fade curtains and upholstery. Conditions of this nature, although they may be normal for the area, are beyond Airstream's control and become the responsibility of the owner.

Although it is our obligation to correct a rain or plumbing leak within the terms of the limited warranty, it is the owner's responsibility to use reasonable, prudent care to minimize foreseeable secondary damage, such as a delaminated floor, stained upholstery, carpeting, drapes etc.

Overload

Damage due to loading, either beyond capacity or to cause improper towing because of improper balance, is beyond Airstream's responsibility. The Airstream trailer is engineered to properly handle the gross vehicle load rating on the certification label. Load distribution has a definite effect upon the towing characteristics and attitudes of the trailer. Level hitch installations are a necessity, and very important on a tandem axle trailer. There are limits to the amount of load that can be safely transported depending upon speed and road conditions, and reasonable cause to believe these factors have been exceeded could void the Airstream warranty. For additional information on the loading of your trailer, consult your Owner's Manual or gross vehicle weight rating plate.

The Airstream axle is manufactured to a tolerance of 1-degree camber and 1/8" toe-in. These tolerances will only change if the trailer is subjected to abuse, such as dropping off a sharp berm, striking a curb, or hitting a deep hole in the road. Such damage could be considered as resulting from an accident which risks are not covered under the warranty. Abnormal tire wear and/or wheel alignment resulting from such damage is not covered under the terms of the warranty.

AIRSTREAM INTERNATIONAL TRAILER OWNERS MANUAL

SERVICE:

The Airstream Silver Key Delivery Program is an exclusive Airstream program. Before leaving the factory, each and every vital part of the trailer is tested for performance. Each test is signed and certified by an inspector. After the trailer arrives on your dealer's lot all of these vital parts and systems are again tested. When you take delivery of your new trailer you will receive a complete check out.

Silver Key Delivery does not stop here. At that time a specified list of performance checks on your trailer equipment will be conducted and any deficiencies you have experienced since taking delivery will be corrected.

Please contact your dealer if you need service. Major service under your Airstream Limited Warranty is available through our nationwide network of Airstream Dealer Service Centers. An up-to-date list of Dealer Service Centers has been provided with your new trailer. This list is current as of the date of this publication.

Occasionally dealerships change, or new dealers are added who may not appear on this list. For this reason, it is suggested that you contact your local dealer from time to time and bring your list up to date. He can also provide you with additional copies if you need them. **ALL CENTERS OPERATE ON AN APPOINTMENT BASIS FOR THE UTMOST EFFICIENCY.**

When you require service from the Airstream Factory Service Center, or a Certified Dealer Service Center, please contact the service manager for an appointment, and kindly inform him if you are unable to keep the appointment date or wish to change it.

Service may be arranged at the Factory Service Center by contacting the Service Coordinator at:

Airstream Factory Service Center
P.O. Box 629
419 W. Pike Street
Jackson Center, Ohio 45334-0629
Phone: 937-596-6111

REPORTING SAFETY DEFECTS

If you believe that your vehicle has a defect, which could cause a crash or could cause injury or death, you should immediately inform the National Highway Traffic Safety Administration (NHTSA) in addition to notifying Airstream, Inc.

If NHTSA receives similar complaints, it may open an investigation, and if it finds that a safety defect exists in a group of vehicles, it may order a recall and remedy campaign. However, NHTSA cannot become involved in individual problems between you, your dealer, or Airstream, Inc.

To contact NHTSA you may either call the Auto Safety Hotline toll-free at 1-800-424-9393 (or 366-0123 in Washington, D.C. area) or write to: NHTSA, U.S. Department of Transportation, Washington, D.C. 20590. You can also obtain other information about motor vehicle safety from the Hotline.

AIRSTREAM INTERNATIONAL TRAILER OWNERS MANUAL

MAINTENANCE SCHEDULE



WARNING: FAILURE TO MAINTAIN YOUR COACH CAN CAUSE PREMATURE AND UNEXPECTED PARTS BREAKAGE AND/OR ERRATIC OPERATION THAT MAY BE HAZARDOUS.

Note: See appliance manufacturer's literature for further information

EVERY 1,000 MILES OR 60 DAYS

Escape Window	Check operation of latches and upper hinge.
*Battery	Check water level
Smoke Alarm	Test and replace battery as required.
Tires	Check tire pressure (See Specifications).
Hitch	Check for loose bolts or unusual wear.
GFI Circuit Breaker	Test and record.



WARNING: On new trailers or whenever a wheel is removed, check lug bolts at 200 miles and 1,000 miles. Torque 85 ft. lbs.

EVERY 5,000 MILES OR 90 DAYS

Exterior Door locks	Lubricate with dry graphite
Exterior Hinges	Lubricate with light household oil
LPG Hold Down	Lubricate with light household oil
LPG Regulator	Check bottom vent for obstructions
Main Door Striker Pocket	Coat with paraffin.
Wheel Lug Bolts	Torque to 85 ft. lbs.
Break Away Switch	Pull pin and lubricate with household oil
7-Way Plug	Spray with contact cleaner.
Hitch Ball Latch	Lubricate with non-detergent motor oil
Hitch Ball	Lubricate with hitch ball lube or wheel bearing grease.
Range Exhaust Hood	Clean fan blades and wash filter.
Roof Vent Elevator Screws	Lubricate with light household oil
Main Door Step	Lubricate moving parts and check.

* As a battery ages and becomes less efficient, the water level should be checked at more frequent intervals.

AIRSTREAM INTERNATIONAL TRAILER OWNERS MANUAL

EVERY 10, 000 MILES OR 6 MONTHS

Brakes	Inspect, adjust or replace as necessary
Wheel Bearings	Clean and repack
Tires	Inspect and rotate
Spare Tire Carrier	Lubricate moving parts.
Seals, Windows & Door	Clean with mild detergent and coat with "Slipicone".
TV Antenna	Lubricate all moving parts with silicone lubricant.
Exterior	Wax (Do not use an abrasive cleaner or wax).
Escape Window	Lubricate latches with WD-40.

EVERY YEAR

Battery	Clean, neutralize and coat terminals with petroleum jelly.
A-Frame, Step	Wire brush and paint frame at front and rear.
LP Bottles	Have purged by LP supplier.

Seams: Check and reseal exterior seams, windows, lights and vents as needed. Use Acryl-R seam sealer or equivalent.

Hitch Coupler and Ball: Check for wear or damage. Assure all parts operate freely. Replace any component if worn or damaged.

AIRSTREAM INTERNATIONAL TRAILER OWNERS MANUAL

SUGGESTED MAINTENANCE PARTS AND LUBRICANTS

BULBS, EXTERIOR

License Plate, Convenience Light (Dump Valve)	# 53, wedge base
Clearance Light, Convenience Light (Hitch)	# 194, wedge base
Door Light	# 1141

BULBS, INTERIOR

Ceiling, Wardrobe, Shower, Galley & Dinette Lights	# 1141
Reading Light, Dinette & Bedroom	# JC-10, wedge base

FUSES

Radio	ATC 15 Amp
Battery Cable Fuses (Canadian approved trailers only)	SLC 50 Amp
Power Center	20 & 30 amp Automotive fuses
Battery Disconnect Relay	ATC 5 amp

12-VOLT BREAKERS (under bed)

50 Amp Type 2
30 Amp Type 2
20 Amp Type 2

MISCELLANEOUS

Water Hose Gaskets	Wheel Bearing Grease
Extra Hair Pin Clips for Hitch	Grease Seals
Dry Graphite	WD-40 or Equivalent Aerosol Lubricant
Oil Can with 30 Weight Non-Detergent Oil	Silicone Lubricant
Light Household Type Oil	Spray Contact Cleaner
Hitch Ball Lube (May use wheel bearing grease.)	Exterior Seam Sealer

AIRSTREAM INTERNATIONAL TRAILER OWNERS MANUAL

NOTES

AIRSTREAM INTERNATIONAL TRAILER OWNERS MANUAL

TOWING YOUR AIRSTREAM

TOW CAR EQUIPMENT

If you plan to buy a new vehicle to tow your trailer we suggest that you include in your purchase the towing options offered by most automobile manufacturers. These include such things as a heavy-duty alternator and radiator, heavy-duty springs (See Note) and shock absorbers, transmission cooler, heavy-duty fan and flasher unit and others, depending upon the make of the vehicle.

Transmissions may be manual or automatic, but an automatic transmission may prolong your car's life and generally does a better job of controlling engine loads than the average driver using a manual shift.

Having adequate power is very important when considering the purchase of a new vehicle or the trailer towing capability of your present one. American manufacturers realize more than 30% of the vehicles they sell will be used for towing some type of trailer. The dealers are provided with guidelines to use when helping a customer decide on a tow vehicle. The guidelines are not just determined by the power output of the engine. The gear ratio of the differential is also a very part of the guideline.

Inspect the vehicle's hitch regularly for loose bolts or nuts, cracked welds, loose ball mounts, and worn parts.

New trailerists often carry more food and other supplies than really needed. Remember that every item you take along is one more thing to stow and adds weight to the total load you must pull. Consolidate items in shelves, lockers, and in the refrigerator. It is better to have one full and one empty locker, than two half empty ones. Special care must be taken not to overload the front and rear ends of the trailer.

NOTE: Be realistic when ordering heavy duty springs. Only springs heavy enough to support your loaded vehicle (not including trailer) are necessary. Too harsh of spring rate will only shorten the life of the tow vehicle and trailer, and will make your journeys less enjoyable.

ELECTRIC BRAKES

The brakes are operated by 12 volt current from your tow vehicle and **MUST BE HOOKED UP SO THAT YOU HAVE AN INTEGRAL SYSTEM WITH YOUR TOW VEHICLE BRAKES.** To prevent problems and insure satisfactory braking action, install an electronic controller in line with the brakes in your tow vehicle.

An electronic controller installed in your tow vehicle will synchronize the trailer brakes with your tow vehicle brakes. It is designed to apply the trailer brakes with your tow vehicle brakes.

Your brake controller should be adjusted to provide for a slight lead of the trailer brakes over the tow vehicle brakes. Follow the directions provided with your controller and keep the information for future reference. Don't be afraid to ask questions! If you don't understand the directions, have the installer explain the procedures.

Due to normal brake lining wear, the brakes and the controller setting should be checked and readjusted, if necessary, during the trailer manufacturer's recommended inspection intervals.

Note: Brake lining adjustment should be periodically checked (fully) to be sure trailer brakes are in the same adjustment as the tow vehicles.

Properly set adjustments will provide for safe comfortable stops. They will also help assure optimum brake and tire life for both the tow vehicle and the trailer.

AIRSTREAM INTERNATIONAL TRAILER OWNERS MANUAL

In THE EVENT OF AN ACCIDENTAL SEPARATION of the tow vehicle and the trailer, the BREAK-AWAY SWITCH will set and lock the trailer brakes for a sufficient length of time to stop the trailer. The switch is activated when the wire attached to it and to the tow vehicle pulls out the small pin in the front of the unit. **THIS PIN SHOULD BE PULLED OUT, LUBRICATED WITH LIGHT HOUSEHOLD OIL, AND REPLACED EVERY 90 DAYS.**

To prevent corrosion within the breakaway switch, pull the switch's pin straight forward and spray the inside of the switch through the hole with an electric contact cleaner (such as Spra-Kleen) and re-insert pin. A drop of light household oil on the groove near the base of the pin will allow the pin to operate freely. **WHEN THE TRAILER IS CONNECTED TO THE TOW VEHICLE, THE BREAKAWAY SWITCH LOOP SHOULD BE ATTACHED TO THE PERMANENT FRAME OF YOUR HITCH.** When disconnecting the trailer from the tow vehicle remove wire loop from the frame. **DO NOT REMOVE PIN FROM SWITCH BECAUSE THIS WILL APPLY THE TRAILER BRAKES.**



WARNING: Do not use breakaway switch for parking brake.

7-way Plug Diagram

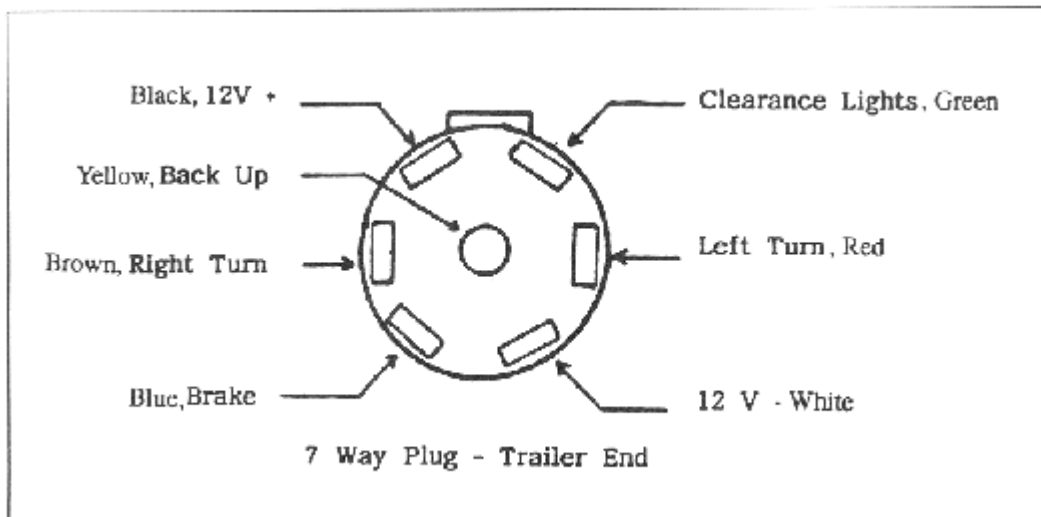

AIRSTREAM INTERNATIONAL TRAILER OWNERS MANUAL

12- Volt Layout

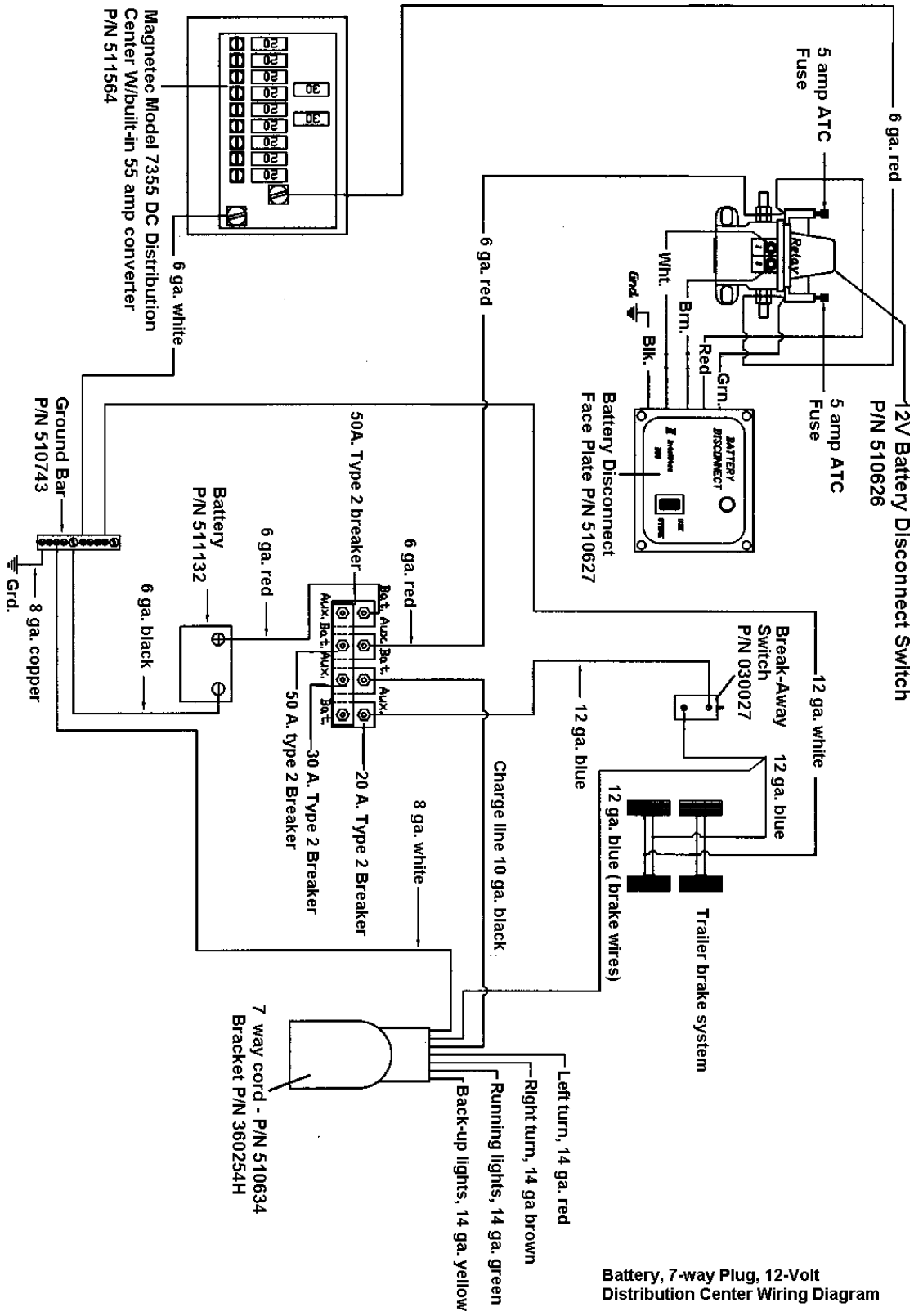

Battery, 7-way Plug, 12-Volt Distribution Center Wiring Diagram

AIRSTREAM INTERNATIONAL TRAILER OWNERS MANUAL

LOADING

Below is a sample of the weight information chart provided in all Airstream vehicles. This information can be found inside the wardrobe of the vehicle about 60" up from the floor on the side panel.

TRAILER WEIGHT INFORMATION

VIN OR SERIAL NUMBER

GVWR (GROSS VEHICLE WEIGHT RATING) IS THE MAXIMUM PERMISSIBLE WEIGHT OF THIS TRAILER WHEN FULLY LOADED. IT INCLUDES ALL WEIGHT AT THE TRAILER AXLE(S) AND TONGUE OR PIN.

UVW (UNLOADED VEHICLE WEIGHT) IS THE WEIGHT OF THIS TRAILER AS MANUFACTURED AT THE FACTORY. IT INCLUDES ALL WEIGHT AT THE TRAILER AXLE(S) AND TONGUE OR PIN. IF APPLICABLE, IT ALSO INCLUDES FULL GENERATOR FLUIDS, INCLUDING FUEL, ENGINE OIL AND COOLANTS.

CCC (CARGO CARRYING CAPACITY) IS EQUAL TO GVWR MINUS EACH OF THE FOLLOWING: UVW, FULL FRESH (POTABLE) WATER WEIGHT (INCLUDING WATER HEATER), FULL LP-GAS WEIGHT.

CARGO CARRYING CAPACITY (CCC) COMPUTATION	POUNDS	KILOGRAMS
GVWR		
MINUS UVW		
MINUS FRESH WATER WEIGHT OF GALLONS @ 8.3 LB/GAL		
MINUS LP-GAS WEIGHT OF GALLONS @ 4.5 LB/GAL		
= CCC FOR THIS TRAILER*		

*DEALER INSTALLED EQUIPMENT WILL REDUCE CCC

CONSULT OWNER MANUAL(S) FOR SPECIFIC WEIGHING INSTRUCTIONS AND TOWING GUIDELINES. CD-132

See specification section in this manual for definition and weight pertaining to this label



WARNING: Never add items such as generators, heavy toolboxes or motorcycle racks to the back of the trailer. Weight behind the axle will tend to magnify any sway that may occur when passing trucks or in gusty wind. If a heavy generator is mounted on the rear bumper what may have been an almost unnoticeable sway turns into a severe sway you may not be able to control.

CAUTION: Damage to your trailer caused by mounting heavy objects on the rear is considered abuse, and is not covered by warranty.

AIRSTREAM INTERNATIONAL TRAILER OWNERS MANUAL

WEIGHING YOUR TRAILER

The diagram below shows how to weigh the trailer on scales.

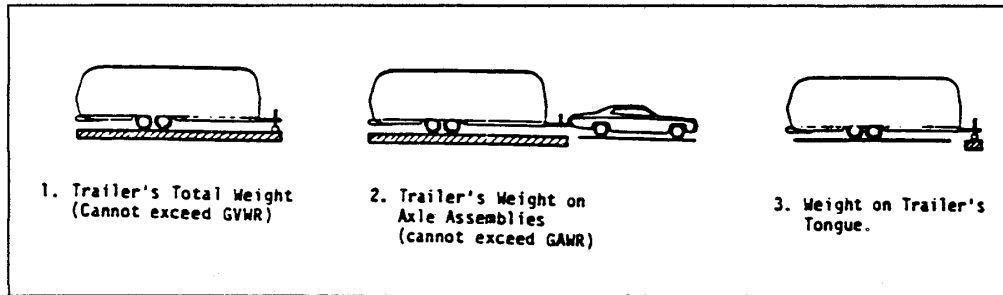

When loading heavy objects such as tools, skillets, irons, and boxes of canned goods, etc. keep them as low as possible - preferably on the floor. Try to hold additional weight behind the axle to a minimum.

CAUTION: The allowable personal cargo must be distributed in your trailer in such a manner that the Gross Axle Weight Rating is not exceeded.

To determine this it is necessary to load all of your allowable personal cargo and variable weights. Then hitch the trailer to the tow vehicle with load equalizing hitch properly adjusted as shown on the following pages.

Place the trailer on a scale with both axles only on the scale (see 2). If the weight on the axles exceeds the axle system G.A.W.R. then some of the personal cargo must be redistributed forward in order to place some of this weight on the tongue.

The tongue weight should be in between 10% - 15% of the trailer's total weight, but must not exceed 1,000 lbs. Some tow vehicle manufacturers may restrict the amount of tongue load to a lower value. To determine tongue load, unhitch tow vehicle and place the tongue hitch post on a scale. The trailer must be properly loaded as determined above, with your allowable personal cargo and variable weights.

Used a scale, such as a bathroom scale, that has a lower weight limit than your tongue load to check the tongue weight by using the following method (see illustration).

Place a piece of wood of approximately the same thickness as the bathroom scales on the ground in line with the trailer hitch jack as shown. It should be so spaced that a short piece of pipe or other round piece will lay exactly one foot from the centerline of the jack extension. Place the scales so that another round piece can be exactly two feet from the centerline of the jack extension in the other direction. Place a 4 x 4 on the two round pieces and screw the jack extension down on the top of the 4 x 4 until the tongue of the trailer is supported by it. Multiply the scale reading by three. This will be the tongue weight of your trailer. If you exceed the capacity of the bathroom scales, increase the two-foot dimension to three or four more feet, but always multiply the scale reading by the total number of feet between the wood and scales.

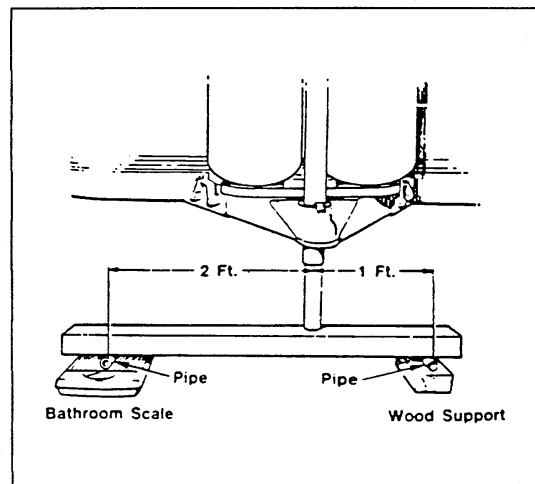

Note: Be sure trailer is level when you read scales.

AIRSTREAM INTERNATIONAL TRAILER OWNERS MANUAL

HITCHING UP

Hitching up your trailer is something that will become almost second nature with practice. The following section includes proper hitch load distribution and a procedure for hitching up.

Equalizing Hitch Load Distribution

When a trailer is hitched up properly to a tow vehicle with a load equalizing hitch, approximately 1/3 of the trailer's tongue weight will be on the trailer's axles and 2/3 will be transferred to the tow vehicle, 1/3 of this weight transfer will be carried by the front wheels and 1/3 by the rear wheels of the tow vehicle (See diagram), Thus, the tire load of each wheel on the tow vehicle will be increased by 1/6 of the trailer's tongue weight. The tire air pressure of the tow vehicle should be increased to compensate for this additional weight. Refer to the vehicle's owner's manual for this information.



WARNING: The tongue weight should be approximately 10% to 14% of the trailer's total weight. Under no condition should it exceed the hitch rating. Your hitch installer should provide your hitch rating information to you.

Sway Control Device

Although Airstream has not intruded into the hitch manufacturers field of expertise and preformed formal testing, we find the vast majority of Airstream owners purchases sway-control devices.

When passed by large trucks or when exposed to sudden crosswinds the trailer will be "pushed" and this action will be felt in the tow vehicle. It's our understanding the sway control devices will reduce the amount of movement and make towing more comfortable and add some safety.

Follow the directions of the sway control manufacturer when having it installed and using it.

Steps for Hitching Up

Jack up the trailer hitch until there is clearance for the HITCH BALL to slide under. Remove the safety pin, slide the locking lever forward and raise the front of the trailer. Back the tow vehicle straight back to the hitch. (See Fig. 2). This can best be accomplished through the use of prearranged hand signals with the help of another person; but if you are hitching up by yourself we recommend the use of a HOOK-UP VIEW MIRROR.

Lower the trailer hitch onto the hitch ball. Then close the locking lever and insert safety pin. (See Fig. 3)

Now raise the trailer and tow vehicle to the full height of the hitch jack (See Fig. 7) and then attach the LEVELING BARS. (See Fig. 4, 5 & 6). Lower the tow vehicle and trailer (See Fig. 7).

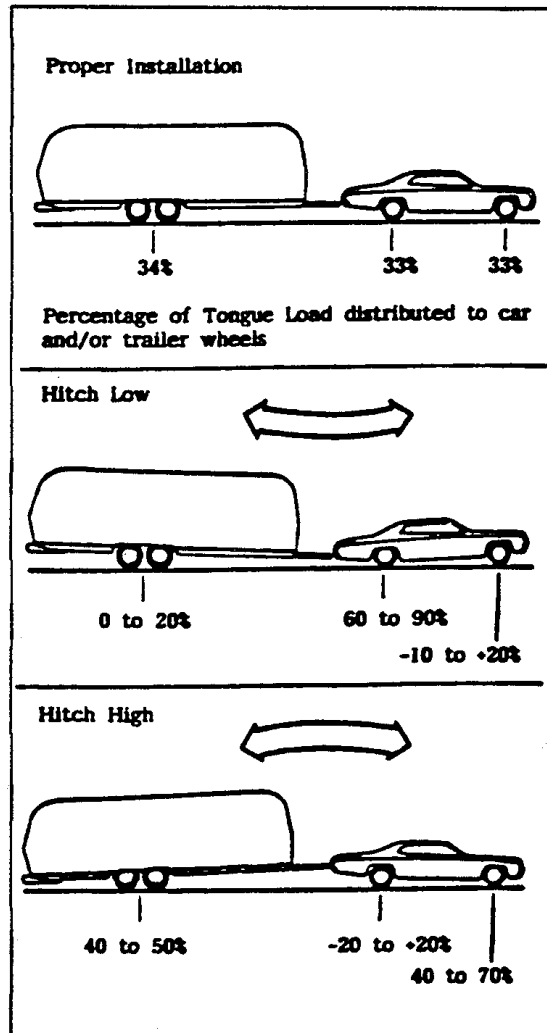

AIRSTREAM INTERNATIONAL TRAILER OWNERS MANUAL

The hitch ball should be level to slightly higher. Readjust leveling bars until this condition is correct by increasing or decreasing the length the chain engaged in A-frame saddle bracket. Short chain raises hitch ball, longer chain lowers it. A level condition will result in the best balance for towing and steering control as the weight-equalizing hitch distributes the hitch load.

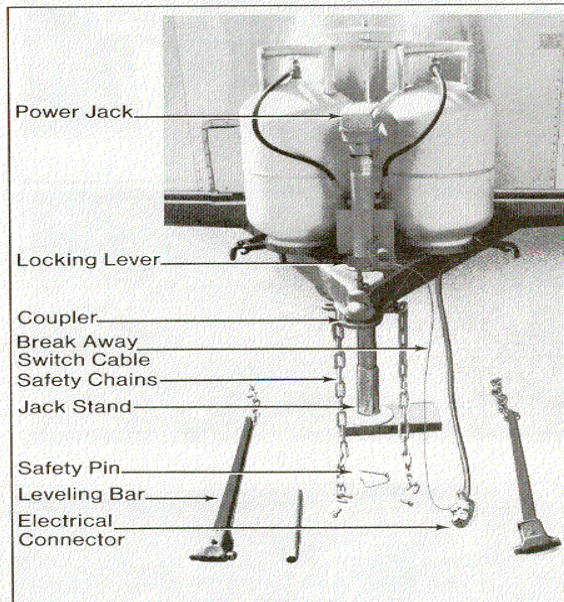

Fig. 1 - Hitching Up Equipment

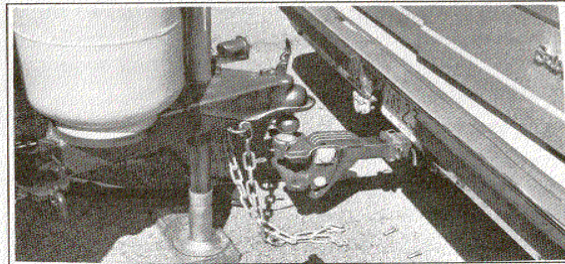

Fig 2 - Hitching Up

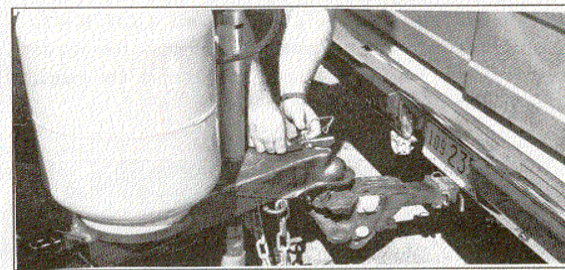

Fig 3

A low hitch ball increases tail wagging tendencies by lowering the nose of the trailer, thus changing the center of support for the trailer and reducing the weight on the wheels of the tow vehicle. With proper hitch installation and hitching up, the bar should have a noticeable amount of the deflection or bending. "See figure 8". A little practice with your rig will teach you how far to pull the bar; you may wish to mark the chain links that match your rig.

Always choose level ground for checking correct hookup.

Note: If your tow vehicle is equipped with adjustable load leveling air shocks, you must load the tow vehicle first with typical luggage and passengers and bring it back to level. Then attach the trailer and adjust the load leveling bars. Otherwise the air shocks on the tow vehicle will overload the rear wheels. **Do not use air shocks to level tow vehicle and trailer after hitching up.**



Fig. 4

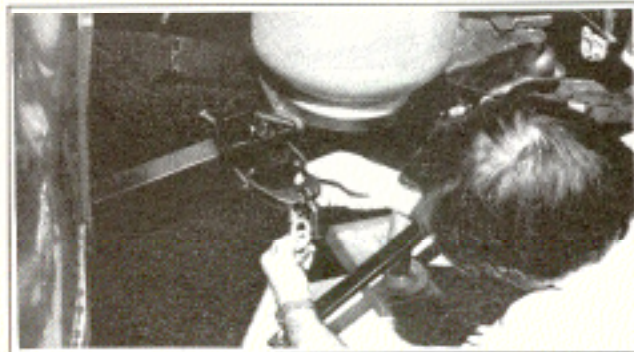

Fig. 5

AIRSTREAM INTERNATIONAL TRAILER OWNERS MANUAL

Note: Level the trailer end to end, then measure from the ground to the top of the ball socket to determine the coupler height on the trailer.

Attach the safety chains (see figure 10) to the welded portion of the hitch or tow vehicle's frame, but never to the removable ball mount. Cross the safety chains under the hitch.

Caution: retract the hitch jack completely for maximum ground clearance. Remove the jack pad (See Figure 12) and stow in the car's trunk along with the leveling jack and other gear used when stopped. **NEVER TOW YOUR TRAILER WITH THE JACK DOWN.** Check that the foldaway step is up and that the main door is completely closed and the deadbolt **LOCKED** for towing. If it is not locked the constant vibration of travel may cause the main door to open with possible damage.



Fig 6



Fig 7

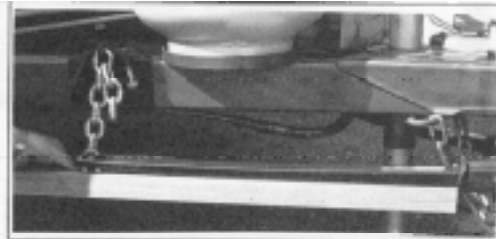

Fig 8



Fig 10



Fig 9



Fig 11

Move the rig ahead about 50 feet and test the trailer brakes, then check the ground for forgotten objects. Regularly check the condition of your tires, air pressure, and the tightness of your lug bolts.

Fig 12

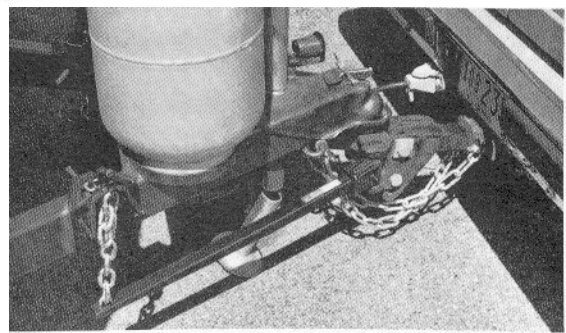

AIRSTREAM INTERNATIONAL TRAILER OWNERS MANUAL

TOWING TIPS

We want every owner to be a safe and courteous driver. A few hours of towing practice in a large empty supermarket lot will make pulling your trailer over the road much easier. Line out two corners for left and right turns. You may also use these corners to practice backing and parking.

OBSERVE THAT THE TRACKS MADE BY THE TRAILER WHEELS ARE DISTINCTLY DIFFERENT FROM THOSE MADE BY THE TOW VEHICLE. Studying this will make it easier for you to correct mistakes. Truck or trailer type fender or door grip rear view mirrors are a must for maximum visibility and in most states the law requires them.

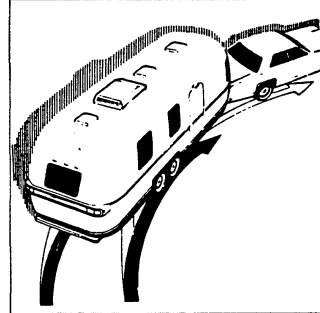
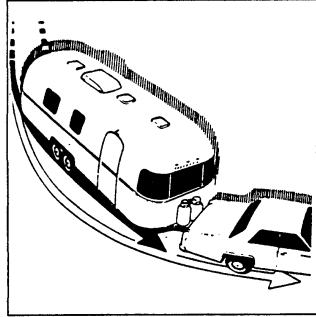

After thoroughly inspecting your hitch, brakes, and tires you should be ready to tow. Check traffic, signal that you are about to pull away, and start slowly. Look often in your mirrors, and observe the action of the trailer, then carefully move into the proper lane of traffic. Remember that the trailer wheels will not follow the path of the tow vehicle wheels; therefore, WIDER TURNS ARE NECESSARY WHEN TURNING TO THE LEFT OR TO THE RIGHT.

ON FREEWAYS OR EXPRESSWAYS try to pick the lane you want and stay in it. Always maintain plenty of space between you and the car ahead, at least the length of the tow vehicle plus trailer for every ten miles per hour. Remember that in order to pass another vehicle you will need longer to accelerate. You must also allow for the length of the trailer when returning to the right hand lane.

Tracking

On a two-lane road cars will be lining up behind you because you travel at a lower speed. It is both courteous and sensible to signal, pull onto the shoulder, and let them pass. Your trailer is designed to be towed easily at any legal speed, so if you are not careful you may be inclined to forget it is there.

The BRAKE CONTROLLER is activated when you apply the brakes of the tow vehicle. Your tow vehicle brakes will automatically apply the trailer brakes first when properly adjusted. This will help keep your tow vehicle and trailer in a straight line and make you stop as if you were driving the tow vehicle alone. If swaying or swerving should occur, briefly operating the controller separate from the vehicle brakes may help correct the situation. Practice this maneuver on a clear highway. Don't wait for an emergency then grope for the controller.

When trailering you might encounter a temporary cooling system overload during severe conditions such as hot days when pulling on a long grade, when slowing down after higher speed driving, or driving long idle periods in traffic jams. If the hot indicator light comes on, or the temperature gauge indicates overheating and you have your air conditioner turned on, turn it off. Pull over in a safe place and put on your emergency brake. Don't turn off the engine. Increase the engine idle speed. Lift the engine hood and check for fluid leaks at the radiator overflow outlet. Check to see that all drive belts are intact and the fan is turning. If you have a problem have it fixed at the next opportunity. If there is no problem, the light should go off or temperature should come down within one minute. Proceed on the highway a little slower. Ten minutes later resume normal driving.



WARNING: Never open a radiator cap when the tow vehicle is hot. Check the coolant level when the vehicle is cool.

AIRSTREAM INTERNATIONAL TRAILER OWNERS MANUAL

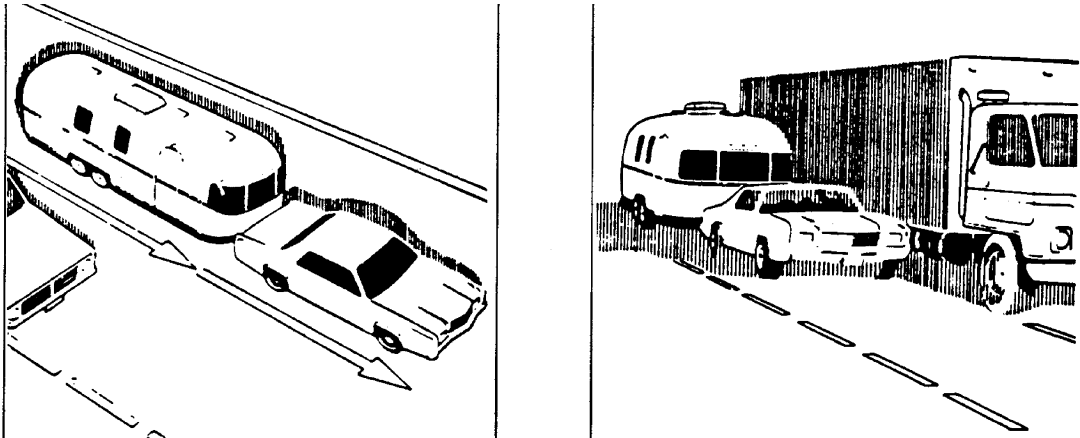

Passing

When going downhill in dry weather, down shift so that engine compression will slow the whole rig down. Take dips and depressions in the road slowly and do not resume normal driving speeds until you are sure that the trailer wheels are clear of the dip.

 **WARNING:** On slippery pavement do not use engine drag to help slow down as this may cause the rear wheels of the tow vehicle to skid. On icy pavement drive slowly and if you feel the tow vehicle skidding gently apply the trailer brakes only. This will bring the tow vehicle and trailer back into a single line. Chains do not help trailer wheels.

CAUTION: When driving in mud and sand let the momentum carry the rig through. Apply power gently and use as little as possible. Stay in the tracks of the vehicle ahead and keep the tow vehicle in the highest possible gear. If you get stuck it is best to tow out the entire rig together without unhitching.

Despite the best hitch you will notice that whenever a large bus or truck overtakes your rig the displaced air first pushes the trailer rear slightly to the right and then affects the front. It may be necessary to steer very slightly, momentarily, toward the bus or truck to help compensate for the sway induced by the passing-vehicle. Do not apply the vehicle brakes, as this can tend to exaggerate the situation. You may find, however, that briefly applying the trailer brakes with your manual control will help eliminate sway.

 **WARNING:** When stopping on a hill or slope, leaving your car in gear is not enough for standstill safety. **CHOCK THE TRAILER WHEELS** to be double sure. Do not use trailer brakes as parking brakes.

AIRSTREAM INTERNATIONAL TRAILER OWNERS MANUAL

Backing Up

In BACKING UP the important thing to remember is to DO EVERYTHING SLOWLY and to correct immediately if you see the trailer turning the wrong way. Concentrate on the rear of the trailer. With your tow vehicle and trailer in a straight line back up slowly and turn the bottom of the steering wheel in the direction you want the trailer to go. Watch out the window or in the mirror until the rear of the trailer is pointing in the desired direction. Your car will be following the trailer in an arc. Straighten the car and trailer by turning the steering wheel more sharply, and then when they are in line, straighten the steering wheel.

ALWAYS TRY TO BACK TO YOUR LEFT BECAUSE THE VISIBILITY IS MUCH BETTER. (See Illustration) When you don't make it on the first try it is usually much easier to pull forward to your original position and start over.

If your spouse or traveling companion normally directs you when backing they should position themselves forward of the tow vehicle so the driver can easily see them. Their directions should always indicate to the driver the direction the rear of the trailer should go. A little practice in a parking lot with the person giving directions can save a lot of frustration when backing into a campsite.

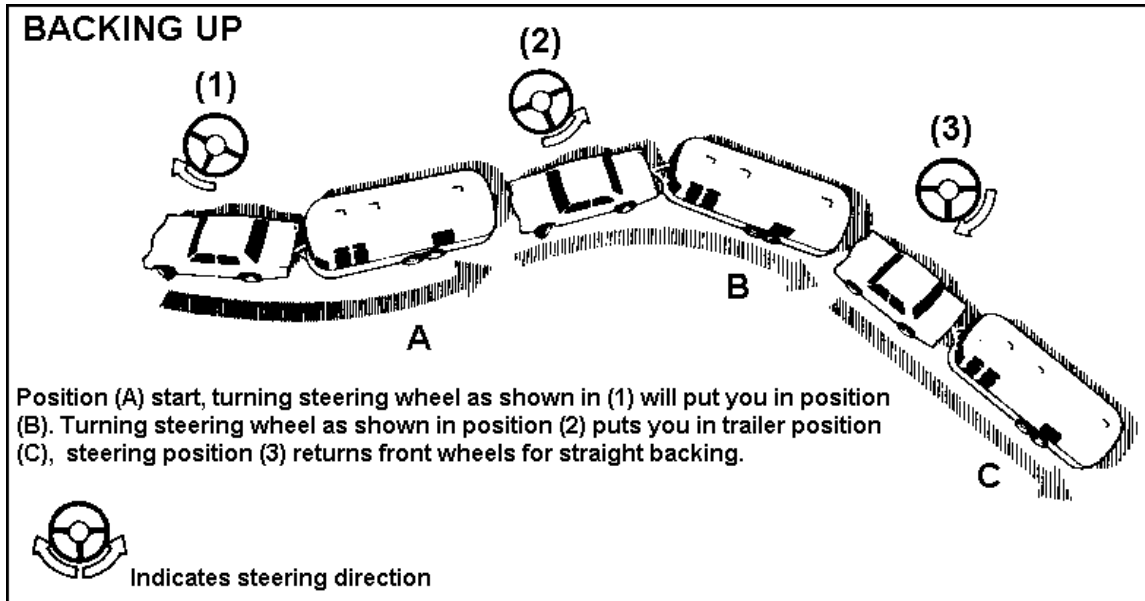

AIRSTREAM INTERNATIONAL TRAILER OWNERS MANUAL

SUGGESTED PRE-TRAVEL CHECK LIST

Interior

1. Turn off water pump switch.
2. Check battery water level.
3. Close windows and vents.
4. Lock all interior cabinet doors.
5. Latch refrigerator door. (Seal containers first.)
6. Hold down or stack securely all loose, hard and sharp objects.
7. Fasten sliding and foldette doors.
8. Drain toilet howl.
9. Turn off interior lights.
10. Set table in upright position.
11. Pull up or retract step.
12. Lower blinds.
13. Secure and lock main door and deadbolt.

Exterior

1. Disconnect and stow the electrical hookup cord, the sewer hookup hose (flush out), and the water hookup hose.
2. Turn off gas at LP tanks.
3. Retract stabilizing jacks.
4. Check Hitch: It must be properly attached.
5. Check safety chains and breakaway switch cable.
6. Fully retract jack. Remove and stow jack stand, foot, or wood block.
7. Check clearance, turn signals, and stop lights.
8. Check lug nuts.
9. Check tires for correct pressure.
10. Check that TV antenna is properly stowed.
11. Adjust tow vehicle mirrors.
12. Pull forward some 50 ft., test brakes, and check site for forgotten objects and cleanliness.

Home

1. Leave house key with your neighbors
2. Valuables and important papers should be stored in a safe place.
3. Newspaper, milk and other deliveries should be discontinued.
4. Ask the Post Office to hold your mail for you.
5. Arrange with the telephone company for discontinued or "vacation service".
6. Arrange care for your pets.
7. Your lawn, garden and houseplants should be cared for.
8. Lock all windows and doors securely. Keep shades open for a lived in look.
9. Cover all food to keep out mice and insects.
10. Eliminate all fire hazards. Place matches in a tin box or glass jar.
11. Store oil, gasoline, and other flammables properly.
12. Destroy all newspapers, magazines and oily rags.
13. Notify police.

AIRSTREAM INTERNATIONAL TRAILER OWNERS MANUAL

Trailer Equipment and Accessories

1. Water hose, 5/8 in. high pressure, tasteless, odorless, non-toxic, (or two 25 ft. sections).
2. "Y" connection for water hose.
3. The sewer hose with clamp.
4. Drain cap with hose drain.
5. Holding tank cleaner and deodorizer.
6. Power cord adapter 30-amp capacity.
7. 50 ft. electric cord, 12-3 wire, 30-ampere capacity.
8. 25 ft. electric cord, 10-3, 30-ampere capacity.
9. Woodblocks for leveling.
10. Wheel chocks.
11. Hydraulic jacks.
12. Cross type lug wrench.
13. Quality tire gauge.
14. Emergency road warning triangle.

Personal

1. Automobile insurance to cover you and your family fully along with proof of insurance.
2. Try to avoid large amounts of cash. Use Travelers Checks and credit cards.
3. Confirm reservations.
4. Have sunglasses for everyone.
5. Pack camera and film.
6. Make a checklist of clothing for everyone, and toilet articles.
7. Prescribed medications.
8. Birth certificate.
9. Medical insurance cards.

Motoring Essentials

1. Display the car and trailer registration properly.
2. Carry valid drivers license.
3. In Mexico you must have special auto insurance.
4. Carry an extra set of the ignition and truck keys in a separate pocket, or in your wallet.
5. Keep an operating flashlight with fresh batteries in the glove compartment.
6. Pack the trunk so that you can reach the tools and spare tire without completely unpacking.
7. Keep sharp or hard articles securely packed wherever they may be.
8. Do not pack things in the passenger seating area. You need the maximum space for comfort.
9. WEAR easy wash, drip-dry traveling clothes.
10. Do not make your vacation trips a mileage marathon. Stop and relax frequently.
11. Carry a first-aid kit.
12. Carry your pet's dish, food, leash, and health and registration papers.
13. In Canada you'll need a non-residence liability insurance card and birth certificate.

AIRSTREAM INTERNATIONAL TRAILER OWNERS MANUAL
NOTES

AIRSTREAM INTERNATIONAL TRAILER OWNERS MANUAL

CAMPING

SAFETY:

Throughout this manual **CAUTION** and  **WARNING** notations are used.

Failure to observe **CAUTION** can damage equipment.  **WARNING** notes the possibility of personal and/or fatal injury if not observed. As always, safety should be one of your top priorities. Make sure you, and everyone traveling with you is familiar with and follows these cautions and warnings.

ESCAPE WINDOW OPERATION

Make sure you, and everyone traveling with you can operate the main door and the emergency exit window(s) rapidly without light. Contemplate other means of escape in case the designated exits are blocked. Run frequent emergency drills. The escape windows(s) are identified by red release handles and are opened by lifting up both latches, then turning the latches toward the center. Push out on the glass and it will swing clear. The window operation should be checked each trip and the latches lubricated with WD-40 or equivalent every six months. A loop is provided in the SCREEN RETAINING SPLINE so it can be rapidly removed. Take hold of the loop and pull the rubber spline out of the screen frame. The window screen can then be easily pushed out.

 **WARNING**: Learn and practice the escape window operation.

 **WARNING**: Check the emergency escape route outside your escape window at every stop. At each campsite make sure you have not parked in such a manner as to block the operation of the escape window by being too close to trees, fences or other impediments. Scenic views are one reason for traveling, but don't park so the beautiful lake or steep cliff is just outside your escape window. Never park your trailer so the escape windows cannot be easily used for emergency exits.

 **WARNING**: You and all your family should practice escape procedures so they can be rapidly accomplished even in total darkness. Never block the interior or exterior access to the emergency escape windows.

 **WARNING**: Read the directions carefully on the fire extinguisher. If there is any doubt on the operation, you and your family should practice, then replace or recharge the extinguisher. You will find your local fire department or any fire safety service will be happy to assist you and answer any questions.

 **WARNING**: Maintain and check smoke detector per its owner's manual recommendations.

 **WARNING**: Always shut off the LP gas when gasoline is added to the tow vehicle.

 **WARNING**: Don't smoke in bed.
Keep matches out of reach of small children!
Don't clean with flammable material!
Keep flammable material away from open flame!

We have all heard these warnings many times, but they are still among the leading causes of fires.

Other safety information on the LPG system of your trailer is located in the plumbing section of this manual.

AIRSTREAM INTERNATIONAL TRAILER OWNERS MANUAL

OVERNIGHT STOP

Airstream owners have parked virtually every place imaginable from filling stations to farmlands. In time you'll develop a knack for spying wonderful little roadside locations by turning off the main highway and exploring.

There are many modern parks including State, County and Federal parks with good facilities where you might obtain electrical, water and sewer hookups. Directories are published which describe in detail these parks and tell what is available in the way of services and hookups.

On overnight or weekend trips chances are you will not use up the capacity of the sewage holding tank, deplete the water supply or rundown the battery which supplies the 12 volt current.

On a longer trip, when you have stayed where sewer connections and utility hookups were not available, it will be necessary for you to stop from time to time to dispose of the waste in the holding tank and replenish the water supply. Many gas stations (chain and individually owned) have installed sanitary dumping stations for just this purpose. Booklets are available which list these dumping stations.

When stopping for the night, your Airstream is built to be safely parked in any spot that is relatively level and where the ground is firm. Your facilities are with you. You are self-contained. Unless the tow vehicle is needed for transportation, it is not necessary to unhitch.



WARNING: Do not park in a manner that would prevent the escape windows from opening.

Try to pick as level a parking spot as possible. Stabilizing jacks or blocks probably won't be required during an overnight stay. However, if you put the jack pad on the hitch jack and run the hitch jack down to take the weight off the car's springs this will provide some stability. If you must park on a slope, **PARK FACING DOWNHILL**. It is easier to level the trailer this way.

All you need to do to enjoy the self-contained luxury of your Airstream is to turn on the LP gas and light any appliances with pilots.

Before moving on, check your campsite for both cleanliness and also be sure you haven't left anything behind. Turn off the gas supply and make sure everything is properly stowed. Use your PRE-TRAVEL CHECK LIST and you are ready for more travel adventure.

AIRSTREAM INTERNATIONAL TRAILER OWNERS MANUAL

EXTENDED STAY

Making a long trip in your Airstream is not very different from making a weekend excursion. Since everything you need is right at hand, you are at home wherever you go. When packing for an extended trip, take everything you need, but only what you need.

When you plan to stay in the same place for several days, weeks or months, you will want your trailer to be as level and steady as possible. Check the attitude with a small spirit level set on the inside work counter or the trailer hitch "A-Frame". (See Diagram Below) If a correction is necessary then **YOU MUST LEVEL FROM SIDE TO SIDE FIRST** This can be done easily by backing the trailer up one or more 2" x 6" boards. (See Diagram) We do not recommend placing tires in a hole for leveling.

LEVEL FROM FRONT TO REAR by disconnecting the hitch from the tow vehicle, putting the jack pad under the hitch jack and adjusting the jack up or down until you are level. Block or chock the wheels to keep the trailer from rolling. Use **STABILIZING JACKS** at the two rear corners as shown in the diagram to eliminate the natural spring action of the axles. **STABILIZING JACKS should only be used to stabilize trailer.**

 **WARNING:** Whenever the trailer must be lifted with a jack, as when changing a tire or leveling on very rough terrain, **ALWAYS PLACE THE LIFTING JACK UNDER THE MAIN FRAME RAIL.** A label is provided to indicate the proper position for the jack. **NEVER USE STABILIZING JACKS or HITCH JACK TO LIFT THE TRAILER.**

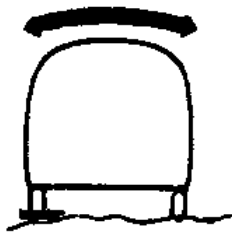

LEVEL FROM SIDE TO SIDE

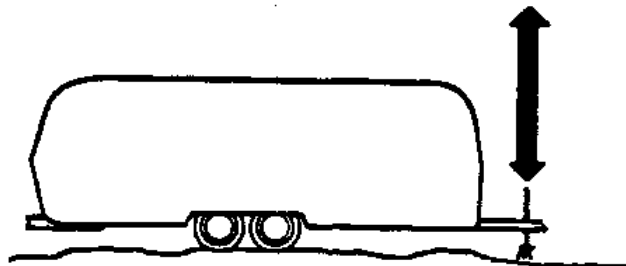

LEVEL FROM FRONT TO REAR

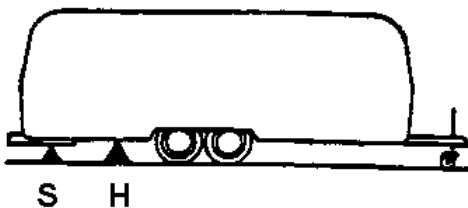

S H



H = Hydraulic Jack Positions

S = Bal or Stabilizing Jack Positions

AIRSTREAM INTERNATIONAL TRAILER OWNERS MANUAL

HOOK UPS

Hook up to **city water** by attaching a ½” minimum high-pressure water hose to the city water service. Be sure all drain valves and the water heater by-pass valves are in the normal use position and turn on the city water tap. Open the hot side of the galley or lavatory faucet. For some time the open faucet will only sputter. This is because the water heater is being filled and air is being pushed out through the lines. Once the water heater is full a steady stream of water will come from the faucet. Now open a cold faucet. It will sputter for a short time, but will soon expel a steady stream. All other faucets can now be opened until all air is expelled.



Once the system is filled with water and the faucets closed, the water system is now ready for use with the city water feed.

CAUTION: Hydrogen gas can be produced in a hot water system served by this heater that has not been used for a long period of time (generally two weeks or more). Hydrogen gas is extremely flammable. To reduce the risk of injury under these conditions, it is recommended that the hot water faucet be opened for several minutes at the kitchen sink before using any electrical appliance connected to the hot water system. If hydrogen is present there will probably be an unusual sound such as air escaping through the pipe as the water begins to flow. There should be no smoking or open flame near the faucet at the time it is open.

The **Power Cord** hook-up is on the roadside of the trailer. The cord may be stored in the rear exterior compartment. The power cord is plugged into the trailer receptacle and the City Power Service.

CAUTION: When operating with city power make very certain that the service is 110 volt and not 220 volt.



Hook your SEWER WATER DRAIN HOSE in the SEWER DISPOSAL FACILITY and attach to the drain outlet in your trailer.

Turn on gas supply. Light the range and oven pilots. Turn on the water heater, refrigerator and furnace.

When you stay for an extended period where electric or water hookups are not available, you must make regular checks on the condition of your 12-volt battery. Hooking up the tow vehicle/trailer electrical connector and running the tow vehicle engine at a fast idle. 45 minutes per day should provide about 3-4 hours of power. Carry drinking water in a clean bucket to refill your tank. When your waste tank nears capacity move to a dumping location.

AIRSTREAM INTERNATIONAL TRAILER OWNERS MANUAL

HOOK UPS

The exterior CABLE TV and TELEPHONE hookups are located on the side of the trailer. It is a gray dual inlet with weatherproof spring loaded caps.



The interior TV hook-up is located above the refrigerator cabinet in the 22 FT. AS model and under the desk and bedroom TV stand in the CCD model.

The interior telephone receptacles are by the main door and under the dinette table in the 22 FT. AS model and under the desk and bedroom TV stand in the CCD model.

Satellite TV hook-up is located above the refrigerator cabinet in the 22 FT. AS model and under the desk and bedroom TV stand in the CCD model.

 **WARNING:** Check your escape window(s) to make sure they will open completely. Also make sure the terrain under the window is suitable for rapid exiting.

AIRSTREAM INTERNATIONAL TRAILER OWNERS MANUAL

WINTER TRAVELING

Traveling in sub-freezing temperatures will require certain precautions to protect the plumbing system and your personal belongings from being damaged by freezing.

Whenever possible the heat should be kept on a constant temperature. It is easier for the furnace to keep a constant room temperature than for the trailer temperature to be allowed to drop 50 degrees Fahrenheit then attempt to raise it to a comfortable level.

The furnace supplies heat to the water lines above the floor for use when hooked to city water. Heat must be maintained inside your trailer to prevent the water lines from freezing. The fresh water, main & auxiliary holding tanks are not heated. These tanks should be drained for travel or use in freezing temperatures. The main (black) and auxiliary (gray) tanks may be used with the proper amount of RV anti-freeze placed in the tanks to prevent freezing. The anti-freeze has to be added to the tanks after each dumping to protect them from freezing when in use. The exterior city water hose must be protected from freezing.

Caution: If at any time the exterior temperature makes it difficult to maintain temperature inside your trailer above the freezing mark all winterizing procedures should be performed immediately. Freezing of liquid and solid wastes in the holding tanks could damage equipment.



WARNING: Always shut off the LP gas and be sure all flames are extinguished before gasoline is added to the tow vehicle.

Some states do not allow LPG to be turned on while moving. While traveling in these states you must use your common sense. How cold is it? How long will it be before you can turn the heat back on? Is the temperature dropping or raising? Remember, when towing at 50 MPH the wind chill factor will cause the interior of the trailer to cool much faster than a trailer that is parked.

When parked in sub-freezing temperatures make sure you keep a full supply of LP gas and plug into a 110 volt power source whenever possible. A fully charged battery will not last more than 8 to 10 hours if the furnace is running almost constantly and 110-volt power is not available.

Leave cabinet doors, wardrobes and bed doors partially open to allow warm air to circulate around plumbing lines and fixtures. Insulate and/or wrap your exterior water lines with heat tape.

CONDENSATION

It is also important to guard against excessive humidity. Cold air will not hold the moisture, and sweating will occur around window frames, on window glass and may occur where structural beams connect the inner and outer walls of the trailer. The best method to combat sweating is to hold water vapor producing functions to a minimum. Boiling water, baths, showers, washing dishes are necessities, but usually can be reduced. Opening windows just slightly on opposite sides of the trailer will also help alleviate the problem. In severe conditions you may want to use a small dehumidifier to aid in reducing condensation.

NOTE: The Airstream trailer is built as a recreational vehicle and is not intended as a permanent dwelling or for more than temporary use in sub-freezing temperatures.

AIRSTREAM INTERNATIONAL TRAILER OWNERS MANUAL
NOTES

AIRSTREAM INTERNATIONAL TRAILER OWNERS MANUAL

EXTERIOR

Cleaning

As a general rule of thumb, we recommend the trailer be washed about every four weeks and waxed in the spring and fall. In industrial areas cleaning and waxing should be done on a more frequent schedule.

CAUTION: ABRASIVE POLISHES OR CLEANING SOLVENTS SUCH AS AUTOMATIC DISHWASHER OR ACID ETCH CLEANERS ARE TOO STRONG AND SHOULD NEVER BE USED. RINSE ALL GRIT FROM SURFACE PRIOR TO WASHING. Use soft rags or wash mitts always moving lengthwise with the trailer. NEVER rub hard on the coating. Even the softest rag will damage the coating if excessive pressure is applied.

ALWAYS CLEAN YOUR TRAILER IN THE SHADE OR ON A CLOUDY DAY WHEN THE ALUMINUM SKIN IS COOL. Oil, grease, dust and dirt may be removed by washing with any mild non-abrasive soap or detergent. Cleaning should be followed by a thorough clean water rinse. Drying the unit with a chamois or a soft cloth may prevent spots and streaks. WHEN WASHING OR POLISHING YOUR TRAILER, ALWAYS WIPE "WITH" THE GRAIN OF THE METAL.

After cleaning and drying, a good grade of nonabrasive automotive paste or liquid wax will increase the life of the finish, especially in coastal areas where the finish is exposed to salt air or in polluted industrial areas. It will also protect the shell from minor scratches and make subsequent cleaning easier.

It is important to remove sap, gum, resin, asphalt, etc. as soon as possible after they appear by washing and waxing. Sunlight and time will bake-harden these materials making them almost impossible to remove without heavy buffing. If asphalt remains on the trailer after washing, use a small amount of kerosene on a rag and wipe the spots individually, being careful not to scratch the finish.

If a substance is found on the coating that cannot be removed by normal washing procedures, Airstream recommends using DX 330 Acryli-Clean made by PPG Industries. Follow all directions and warnings on the product container. Acryli-Clean should be used by trained personnel only, using the proper equipment under controlled conditions. Use the Acryli-Clean as sparingly as possible to remove glue, tar, and other similar substance.

To keep your trailer looking new, paint the "A" frame, LPG tanks, and rear frame periodically.

It is recommended that the caulking and sealant used in external seams and joints such as end shell segments and around window frames, light bezels, beltline and rub rail molding, etc. be checked regularly. If this material has dried out and become cracked or checked, or if a portion has fallen out, it should be replaced with fresh material to prevent possible rain leaks. Caulking and sealing material is available from your Airstream dealer.

Precautions should be taken to prevent excessive sealant from getting on the coated surfaces. Remove excessive sealant before it cures using DX 330 Acryli-Clean made by PPG Industries as explained above.

CAUTION: It may be possible for solvents other than those recommended to extract materials from sealants that could stain the coated surface or could prove harmful to the sealants; therefore, these possible effects must be considered. Test a small area first.

AIRSTREAM INTERNATIONAL TRAILER OWNERS MANUAL

Main Door

CAUTION: When towing, the door lock and deadbolt must be secured. If they are not locked, the constant vibration of travel may cause the door to open with possible damage.

Screen Door

The screen door secures to the main door by means of a slide bolt type latch. It can be operated independently by releasing the slide bolt and swinging the screen door away from the main door. For easier access to the interior main door handle, remember to leave the screen door plastic closeout in the open position when closing the main door.

Step

To operate the step, lift up and pull the step towards you, then lower the step down into position.



WARNING: Once the step is lowered, press down on it to make sure it is secure.

CAUTION: Never travel with step lowered or extended.

Exterior Windows

The windows in your trailer are safety glass. To open: release the two lever locks at the bottom, lift up on the two side operator handles until the window is in the desired position, and place the operators into one of the three positioning slots on the side of the frame. To lock the windows reverse this position



WARNING: Read and follow all warnings and escape window operation in the Camping section under Safety in this manual.

Clean your trailer windows the same way you clean the windows in your home. Clean the seals with a damp cloth or mild detergent every three to six months, taking care not to use strong solvents, as they will damage the seals. A coat of natural silicone lubricant applied after the seal has dried will keep it flexible. Spread the lubricant evenly with a brush or finger, working it into the surface. This is a good practice for all rubber seals in your trailer. For replacement of a damaged window contact an Airstream Service Center.

Your PLASTIC SCREENS are easy to maintain. Clean occasionally with a damp cloth. **Note:** They will melt at the point of contact if touched by a cigarette.

Awnings

Complete instructions have been provided with your awning. You should make sure your traveling companion is familiar with the operation of the awning. If a sudden wind should come up, or if high wind is forecast, the awning should be retracted, stowed and travel locks engaged. Awnings should be extended at an angle to encourage the run off of rain. Awning damage such as a bent tube, torn canvas, or broken arms due to high winds or water standing on the canvas are not covered by warranty. Use the center support bar if your patio awning is so equipped.

Caution: Travel locks on all awnings should be engaged before traveling.

AIRSTREAM INTERNATIONAL TRAILER OWNERS MANUAL

Chassis

The standard RECOMMENDED HITCH BALL HEIGHT for your Airstream is 18" on all models. If you plan long trips with the trailer heavily loaded you should check your trailer, after loading, to determine the optimum height. To check, park the trailer on a level surface and crank the front jack up or down until the measurement from the frame to the ground is the same front and rear. Measure from the ground to the upper surface of the hitch ball coupler. Add one inch to this figure when setting the ball height on the tow vehicle to allow for the suspension settling under the added weight.

 **WARNING** - ALWAYS OPEN LATCH HANDLE BEFORE INSERTING BALL.

OPERATION INSTRUCTIONS

1. To open - slide forward and pull up to open latch before inserting ball
2. Place coupler on ball of same diameter as coupler and of same or greater capacity.
3. When ball is completely nested in socket, push top of latch handle rearward until handle snaps into closed position. (Figure 2)
4. Extend jack to ground and lift car/trailer combination 2-4" to insure coupler is securely attached to tow ball. Retract jack before towing.
5. Insert padlock through hole in handle for theft prevention.

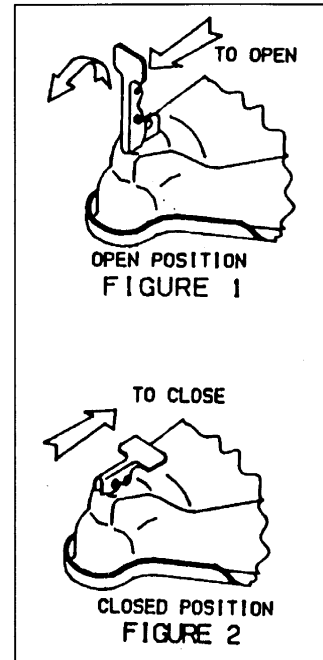

POWER JACK

Hi-Power Acme 3,000

A switch located on the bottom of the housing operates the power jack. When the jack is fully extended or retracted internal limit switches automatically shut off the motor. The jack is wired directly to the battery with an inline fuse.

 **WARNING:** Keep hands and feet from under the footplate when using the jack.

When the high-powered jack reaches the end of its travel, (either raising or lowering) internal limit switches automatically shut motor off.

Dolly wheels are not recommended.

 **WARNING:** Avoid the risk of injury to yourself and others.

- Use the jack for lifting the trailer only
- Never get beneath the travel trailer when only the power jack supports it.
- Support the vehicle by appropriate means.

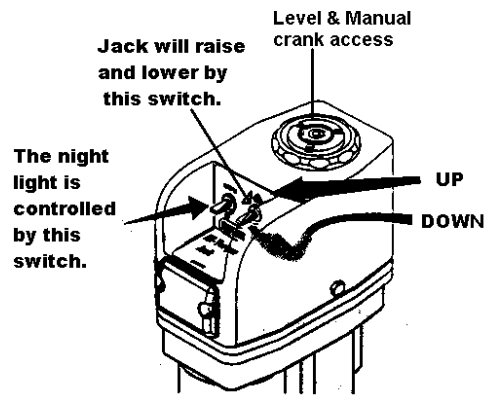

AIRSTREAM INTERNATIONAL TRAILER OWNERS MANUAL

If an electrical failure should ever occur the emergency handle may be inserted into the jack post and the jack can be raised or lowered. Access can be obtained by twisting level cap off.

If power head is removed the crank can still be used.

Caution: If power head is removed it must be synchronized with the jack post.

Caution: Leave tow vehicle transmission in neutral when lifting both units. Dolly wheels are not recommended. Always retract stabilizing jacks before using your jack under load.

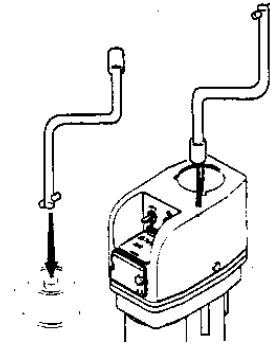

! WARNING: Do not use the electric toggle switch (raise and lower) with the manual crank in place on the jack post. The crank will spin if the switch operates motor and will cause serious injury.

Maintenance

Once a year the power head should be removed and a liberal amount of grease (preferably a grease with high melting point) applied directly to the coupling on which the drive pin rests. **DO NOT POUR OIL** into the top of the jack post.

Once a year the housing cover should be removed and the gears inspected for proper lubrication. Remove 4 screws and tap around the edges of the housing to free the cover. **DO NOT** insert screwdriver blade, this may damage mating surfaces. If lubrication is needed, use Mobilith 460 grease or its equivalent.

JACK ASSEMBLY WIRING DIAGRAM

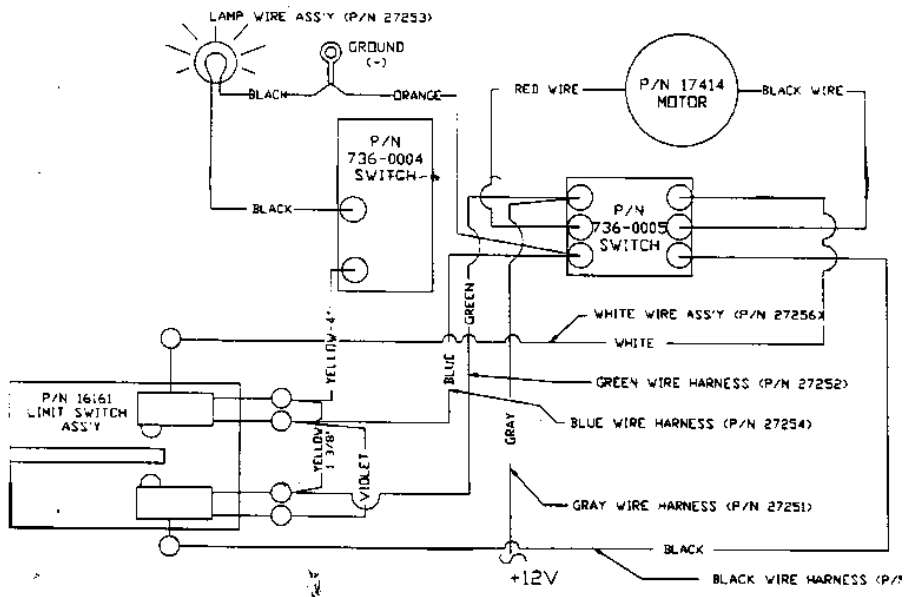

AIRSTREAM INTERNATIONAL TRAILER OWNERS MANUAL

Power Jack Parts Diagram

MANUFACTURER:
Barker Manufacturing Co.
730 east Michigan Ave.
Battle Creek, MI. 49014

Customer Service Phone
& Parts Ordering
616-965-2371
Part Numbers are on Next Page

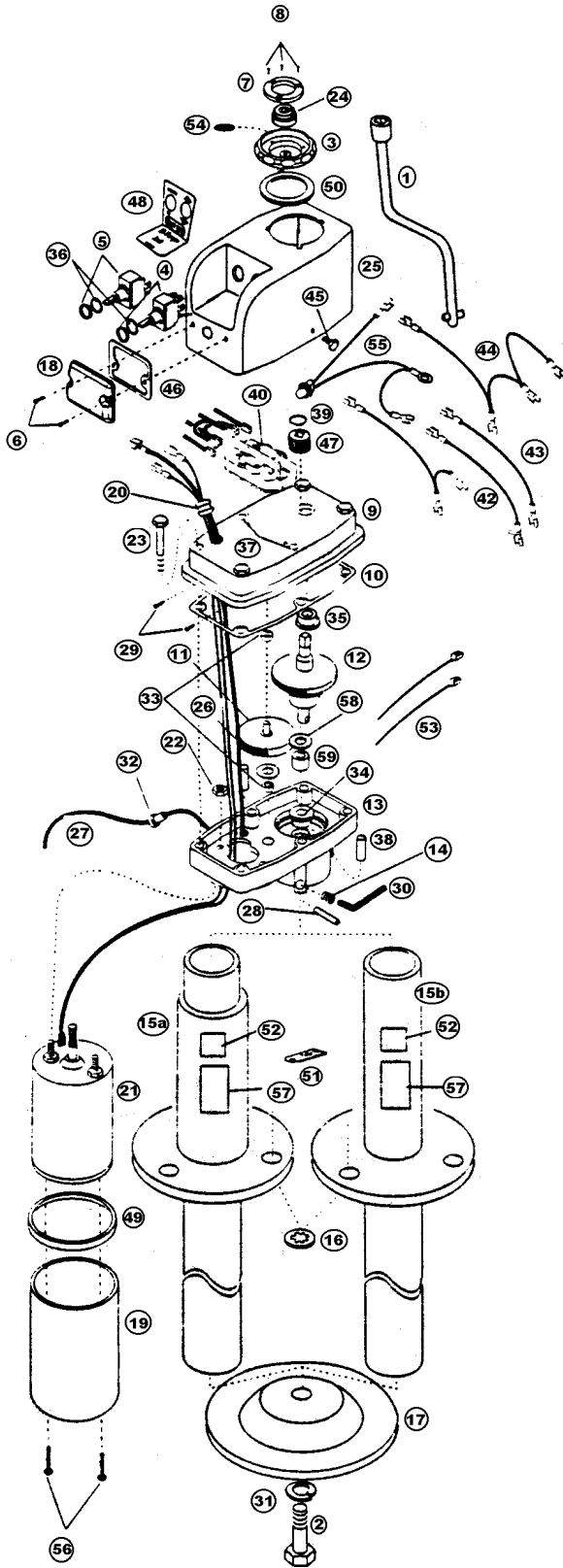

P/N	Required #	Description
1. 21047	1	CRANK
2. 600-0011	1	HEX BOLT 1/2-20X 3/4
3. 27268	1	CAP, MACHINED-BLACK (27341 WHITE)
4. 736-0005	1	ACTUATOR TOGGLE SWITCH AND NUT

AIRSTREAM INTERNATIONAL TRAILER OWNERS MANUAL

5.	736-0004	1	LAMP TOGGLE SWITCH AND NUT
6.	606-5001	2	#10 X 1/2 PHILLIPS HEAD SCREW
7.	27343	1	LEVEL RETAINER-WHITE (27269 black)
8.	606-0011	3	#6-32 X 5/8 TYPE 'F' SCREW
9.	27247	1	UPPER HOUSING
10.	17422	1	GASKET
11.	22012	1	DRIVE GEAR ASSEMBLY
12.	27248	1	OUTPUT GEAR ASSEMBLY
13.	23674	1	LOWER HOUSING BLACK (25697 WHITE)
14.	608-0006	3	5/16-18 X 1/2" SET SCREW
15A.	27313	1	POST ASSY. (BLACK-2 1/4" OD)
15A.	27527	1	POST ASSY. (WHITE-2 1/4")
15B.	27335	1	POST ASSY. (BLACK-2- OD)
16.	619-0003	3	INTERNAL TOOTH LOCK WASHER
17.	21349	1	FOOT PLATE (BLACK)
17.	12752	1	FOOT PLATE (SILVER, WHITE)
18.	27262	1	LENS
19.	27276	1	MOTOR SLEEVE (BLACK)
19.	27344	1	MOTOR SLEEVE (WHITE)
20.	26236	1	RUBBER GROMMET
21.	17414	1	ELECTRIC MOTOR
22.	611-2100	2	HEX LOCK NUT
23.	605-0012	4	SCREW
24.	27272	1	CIRCULAR LEVEL
25.	27338	1	COVER (WHITE)
25.	27259	1	COVER (BLACK)
26.	80208	1	WASHER, SPACER
27.	27251	1	GREY WIRE ASSEMBLY
28.	623-1216	1	GROOVE PIN
29.	606-0009	2	#10 X 3/8 SCREW (LIMIT SWITCH)
30.	636-0000	1	HEX KEY
31.	618-1002	1	LOCK WASHER 1/2"
32.	80504	1	SNAP BUSHING
33.	80501	2	BUSHING
34.	645-0024	1	FLANGE BUSHING
35.	641-0009	1	BUSHING
36.	635-0015	1	"O"-RING TOGGLE SWITCH SEAL
37.	16434	2	HOLE PLUG
38.	621-0004	2	1/8" DIA X 3/4 DOWEL
39.	634-0023	1	RETAINER RING
40.	27512	1	LIMIT SWITCH ASSY.
41.	27257	1	BLACK WIRE ASSEMBLY
42.	27256	1	WHITE WIRE ASSEMBLY
43.	27254	1	BLUE WIRE ASSEMBLY
44.	27252	1	GREEN WIRE ASSEMBLY
45.	606-0008	2	#10-16 X 3/4" TEK SCREW (BLACK)
45.	606-0010	2	#10-16 X 3/4" TEK SCREW ZINC PLATED
46.	27263	1	LENS GASKET
47.	27277	1	POT/REED DRIVE GEAR
48.	27264	1	COVER LABEL
49.	27274	1	MOTOR SEAL
50.	27273	1	CAP GASKET
51.	26351	1	I.D. TAG (55:1)
52.	24047	1	WARNING LABEL
53.	17892	2	CABLE TIE GRAY
53.	16392	2	CABLE TIE BLACK
54.	620-0000	1	WAVE SPRING
55.	27253	1	LAMP WIRE ASSY
56.	603-5017	2	#10-32 x 5/8" PHILLIPS SCREW (BLACK)
56.	603-5011	2	#10-32 x 5/8" PHILLIPS SCREW (SILVER)
57.	12393	1	SYNCHRONIZE LABEL
58.	14459	1	THRUST WASHER
59.	14489	1	1/2" X 5/8" X 3/4" BEARING

AIRSTREAM INTERNATIONAL TRAILER OWNERS MANUAL

TIRES

Your trailer is equipped at the factory with name brand trailer tires. Airstream dealers cannot make adjustments to tires. A dealer who handles that particular brand must do this. If you ever have tire problems check the local telephone directory for the nearest dealer.

To get the maximum performance from your tires check the air pressure often, but only when the tires are cool. Never bleed out air immediately after driving. Recommended tire pressures vary with tire type and size.



WARNING: It is also important to periodically check on the tightness of lug nuts. They should be tightened to a torque of 85 ft. pounds. Care should be taken at all times when handling the wheel because of possible damage to its appearance.

Try to park out of the sun whenever possible when in warm climates. In desert regions use tire covers to prevent ultra-violet deterioration to tires.



Tire Changing

To CHANGE A TIRE with a jack see the label affixed to the underbelly to the rear of the wheels. This label, says JACK with an arrow and points to a plate riveted to the mainframe rail where the jack head must be placed. A flat tire may also be changed without the aid of a jack. Drive the unit up on a ramp 8" wide, 6" high, and about 3 feet long at its base. Position the good tire on the ramp. This will raise the flat tire clear of the ground.



WARNING: Never attempt to change any tire without securely chocking remaining wheels. Never position yourself in a manner where a raised trailer can come down on you if it should become dislodged from a jack or ramp.

All tire and wheel assemblies are balanced at the factory. Be sure to rebalance the tire and wheel assemblies each time a tire is changed.



WARNING: When removing aluminum-forged wheels, if so equipped, from the spindle, it is very important to mark them to assure the wheel is placed in the same position of the drum when reinstalling. If the aluminum-forged wheel is to be mounted on a different drum it is important to sand all loose corrosion from the mating surfaces.

AIRSTREAM INTERNATIONAL TRAILER OWNERS MANUAL

In an emergency you may remove the flat tire. The independent suspension of the Rubber Torsion Axle allows four or six wheel units to be safely towed on three or five wheels for a short distance (100 miles maximum) and only at a low speed (30 MPH).

Be especially cautious in crossing holes or dips in the road. Under these circumstances it is good practice to set your rear view mirrors so that you can observe your tires at all time.

Tips on Tire Care

Any tire, no matter how well constructed, may fail in use as a result of punctures, impact damage, improper inflation or other conditions resulting from use. Tire failures may create a risk of property damage or personal injury. To reduce the risk of tire failure we strongly recommend the following:

1. Check the pressure in your tires, including your spare, at least monthly when the tires are cool (after the vehicle has stopped three hours and then driven less than one mile.) Do not reduce pressure when tires are hot. Use a tire gauge to check pressure and maintain it at the recommended level.
2. Never overload your tires. The maximum load carrying capability of your tires is molded on the sidewall of the tire.
3. Check your tires frequently for scrapes, bulges, separations, cuts or snags resulting from use. See your tire dealer immediately if any such condition is discovered.
4. Never operate your vehicle in excess of lawful speeds or the maximum speeds justified by driving conditions, or in excess of speeds recommended for the tire you are using.
5. Make every effort to avoid running over objects that may damage the tire through impact or cutting, such as chuckholes, glass, metal, etc.
6. Never drive on smooth tires. Tires should be removed when $2/32$ nds inch of tread depth remains. In most states it is illegal to drive with less than $2/32$ nds inch remaining tread depth.

AIRSTREAM INTERNATIONAL TRAILER OWNERS MANUAL

TIRE ROTATION

(10,000-mile intervals)

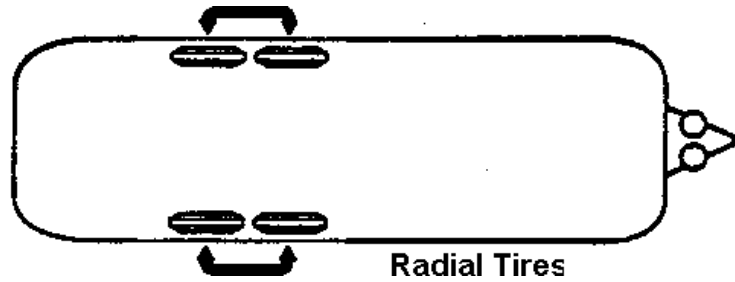

SPARE TIRE & CARRIER (Optional)

The spare tire for Airstreams is stored under the front of the trailer. The front handle of the tire carrier is a one-inch tube protruding out from under the front A-frame on the curbside. It is secured by a bracket and bolt along the inside of the A frame rail. Removing the bolts allows the front on the tire carrier to be lowered and the spare tire removed.

AIRSTREAM INTERNATIONAL TRAILER OWNERS MANUAL

AXLE AND RUNNING GEAR ASSEMBLY

Hitting chuck holes or rough railroad tracks while going straight will only cause misalignment after the tire has been struck many repetitive times. Of course, a deep enough hole can affect the alignment immediately.

The worse culprit is a curb because they are normally struck at an angle. Surprisingly rear axles are occasionally damaged when people are attempting to park beside a curb and are backing up their trailer.

As you look under your trailer is it normal for the axle to be bent up in the middle. This bend is how the camber is obtained.

Toe-in is built into the axle by very slight bends in the axle tube on each end.

If tire wear ever indicate misalignment check with your dealer for the nearest location having the proper equipment.

Each RUBBER TORSION axle is aligned during manufacturing, and double-checked on a random basis. Alignment after delivery is the customer's responsibility.

CAUTION: Never allow heat to be applied to the axle tube since the rubber providing the spring torsion action will be severely damaged.

Rubber torsion Axle Alignment Specifications

Toe-In each side 1/16"	Tolerance 1/16" + or -
Camber each side 3/4° positive	Tolerance 3/4° + or -

Wheel Bearing Maintenance

1. Jack trailer at marked jack location pad behind axle on mainframe,
2. Remove hubcap or spindle cover, wheel and tire.
3. Remove cotter pin.
4. Remove dust cap.
5. Remove spindle nut and washer.
6. Remove bearings, hub and rotor.
7. Lay down hub and rotor with inside grease seal down. Knock out inner bearing and grease seal using wood or plastic dowel and hammer.
8. Clean all parts thoroughly with kerosene.
9. Check all bearings and races for chips or roughness of any kind. Any damaged component must be replaced.
10. Pack bearing with a good grease (No 2 grade-265 ASTM penetration or equivalent).
11. Install inner bearing.
12. Install new grease seal in hub or rotor using wooden or rawhide mallet.
13. Install hub and drum on spindle.

AIRSTREAM INTERNATIONAL TRAILER OWNERS MANUAL

14. Install outer bearing.

15 Install washer and spindle nut

16. While rotating the wheel, tighten the spindle nut with a 12" wrench until there is a slight tension. Then back off one notch and install cotter pin. There should now be from .001" to .010" endplay in hub. If not, back off one notch.

17. Check and retighten the lug bolts, if necessary, every 50 miles for the first 200 miles of travel. They should be tightened to torque of 85 ft. lbs.

When greasing bearings by hand, place a glob of grease in the palm of one hand and push the large end of the bearing down into the grease (see illustration). Keep turning the bearing around and forcing it down through the grease until the grease is extruded up through the opposite end. Wipe the extra grease in your hand around the outside of the bearing. It's not necessary to fill the hub and dust cap with grease.

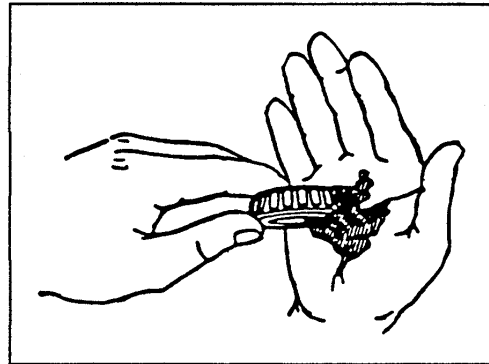

AXLE AND RUNNING GEAR ASSEMBLY

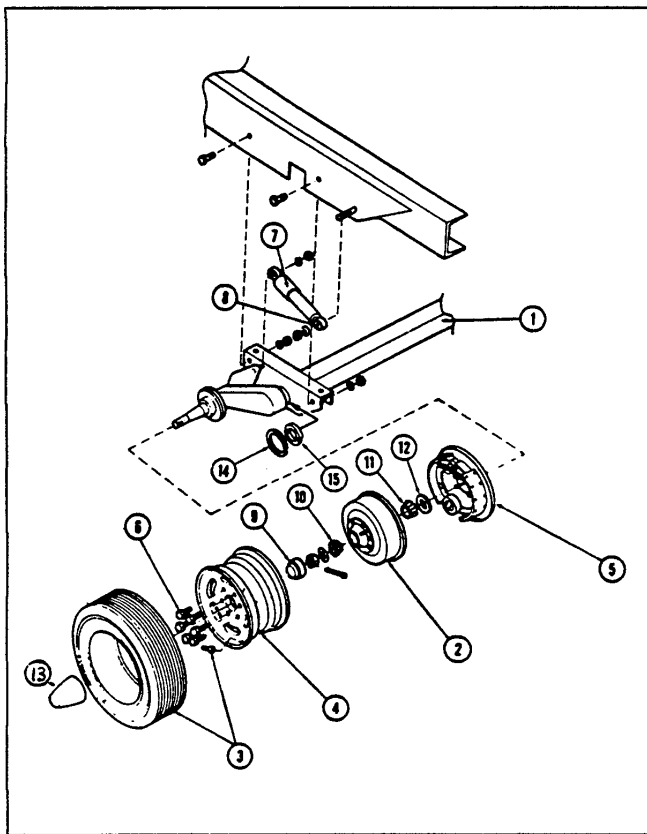

1. Rubber torsion Axle
2. Unicast Hub and Drum
3. Valve Stem
4. Wheel
5. Brake Set
6. Lug Nuts
7. Shock Absorber
8. Shock Absorber Bushing
9. Dust Cover
10. Outer Bearing
11. Inner Bearing
- 12 Grease Seal
13. Spindle Cover
14. Retainer Bearing
15. Nylon Bushing

AIRSTREAM INTERNATIONAL TRAILER OWNERS MANUAL

ELECTRIC BRAKES

A CONTROLLER installed in your tow vehicle will synchronize the trailer brakes with your car brakes. It is designed to apply the trailer brakes whenever the tow vehicle brakes are applied.

ELECTRONIC CONTROLLERS are inertially activated. The controller senses deceleration and generates an output, which reflects the inertia sensed. When you are stationary, the controller does not apply the brakes unless the manual slide bar is activated.

NOTE: Study all material provided with your particular brake control. If you don't understand the information, have the installer explain the information to you or call the manufacturer of the controller.

In THE EVENT OF AN ACCIDENTAL SEPARATION of the tow car and trailer, the BREAKAWAY SWITCH will set and lock the trailer brakes for a sufficient length of time to stop the trailer. The switch is activated when the wire attached to it and to the car pulls out the small pin in the front of the unit. THIS PIN SHOULD BE PULLED OUT, LUBRICATED WITH LIGHT HOUSEHOLD OIL AND REPLACED EVERY 90 DAYS.

To prevent corrosion within the breakaway switch, pull the switch's pin straight forward and spray the inside of the switch through the hole with an electric contact cleaner (such as Spra- Kleen) and reinsert the pin. A drop of light household oil on the groove near the base of the pin will allow the pin to operate freely. WHEN THE TRAILER IS CONNECTED TO THE TOW CAR, THE BREAKAWAY SWITCH LOOP SHOULD BE ATTACHED TO THE PERMANENT FRAME OF YOUR HITCH. When disconnecting trailer from tow vehicle remove wire loop from the frame. DO NOT REMOVE PIN FROM SWITCH BECAUSE THIS WILL APPLY THE TRAILER BRAKES.

TYPICAL ELECTRONIC CONTROLLER

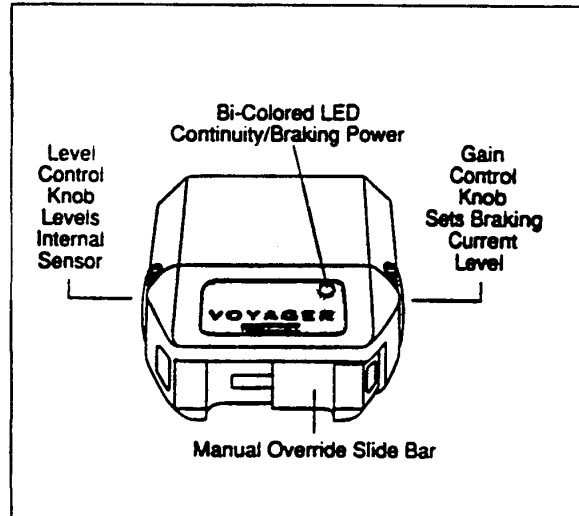

WARNING: Do not use breakaway switch for parking brake.

AIRSTREAM INTERNATIONAL TRAILER OWNERS MANUAL

HOW ELECTRIC BRAKES WORK

The electric brakes on your trailer are similar to the drum brakes on your automobile. The basic difference is that your automotive brakes are actuated by hydraulic pressure while your electric trailer brakes are actuated by an electromagnet. With all of the brake components connected into the system, the brakes will operate as follows: (See Figure A).

When electrical current is fed into the system by the controller, it flows through the electro- magnets in the brakes.

The high capacity electromagnets are energized and are attracted to the rotating armature surface of the drums, which moves the actuating levers in the direction that the drums are turning.

The resulting force causes the actuating cam block at the shoe end of the lever to push the primary shoe out against the inside surface of the brake drum.

The force generated by the primary shoe acting through the adjuster link then moves the secondary shoe out into contact with the brake drum.

FIGURE A

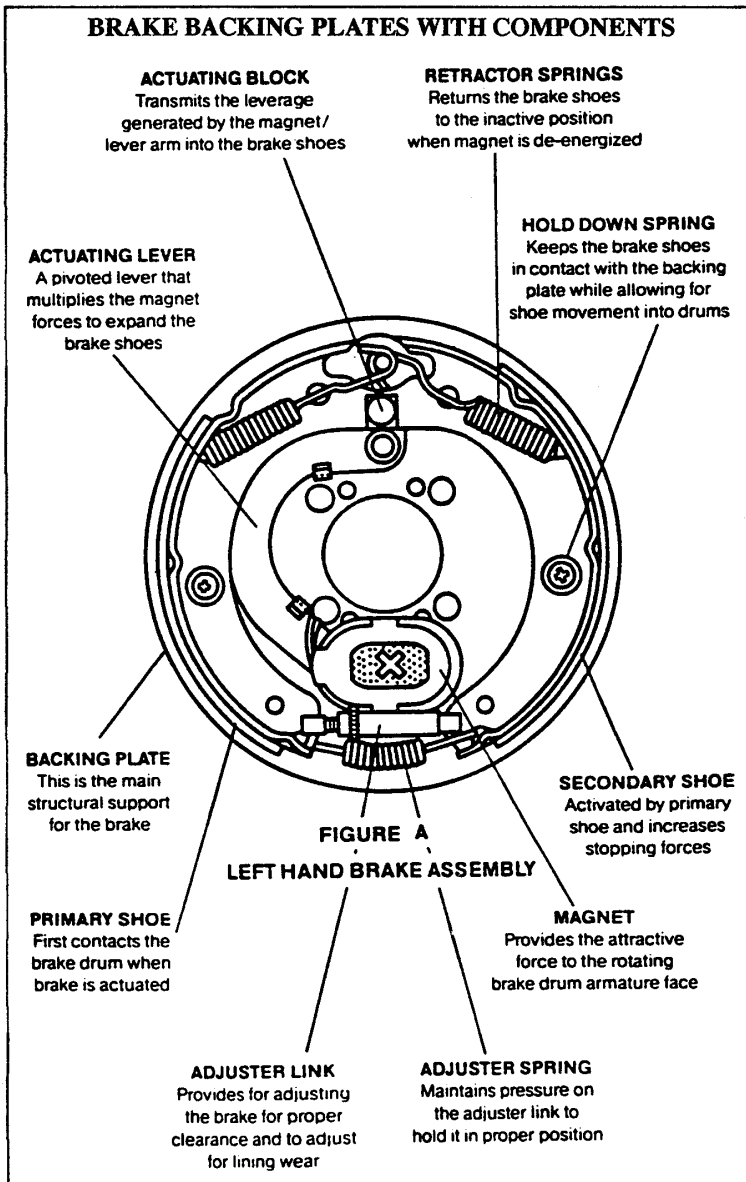

Increasing the current flow to the electromagnet causes the magnet to grip the armature surface of the brake drum more firmly. This results in increasing the pressure against the shoes and brake drums until the desired stop is accomplished.

AIRSTREAM INTERNATIONAL TRAILER OWNERS MANUAL

HOW ELECTRIC BRAKES HELP

Electrically actuated brakes have several advantageous features over other brake actuation systems.

1. They can be electrically adjusted to provide the correct braking capability for varying road and load conditions.
2. They can be modulated to provide more or less braking force, thus easing the brake load on the towing vehicle.
3. They have relatively no lag time from the moment the tow vehicle's brakes are actuated until the trailer brakes are actuated.
4. They provide a separate braking system to that of the tow vehicle, which can be of benefit in the event of tow vehicle brake failure.

HOW TO USE YOUR ELECTRIC BRAKES PROPERLY

Your trailer brakes are designed to work in synchronization with your tow vehicle brakes. Never use your tow vehicle or trailer brakes alone to stop the combined load.

Your trailer and tow vehicle will seldom have the right amperage flow to the brake magnets to give you comfortable, safe braking unless you make proper brake system adjustments. Changing trailer load and driving conditions as well as uneven alternator and battery output can mean unstable current flow to your brake magnets. It is therefore imperative that you maintain and adjust your brakes as set forth in this manual, use a properly modulated brake controller, and perform the synchronization procedure noted below

In addition to the synchronization adjustment detailed below, electric brake controllers provide a modulation function that varies the current to the electric brakes with the pressure on the brake pedal. It is important that your brake controller provide approximately 2 volts to the braking system when the brake pedal is first depressed and gradually increase the voltage to 12 volts as brake pedal pressure is increased. If the controller "jumps" immediately to a high voltage output, even during a gradual stop, then the electric brakes will always be fully energized and will result in harsh brakes and potential brake lockup.

Proper synchronization of tow vehicle to trailer braking can only be accomplished by road testing. Brake "lockup, grabbiness, or harshness" is quite often lack of synchronization between the tow vehicle and the trailer being towed, too high of a threshold voltage (over 2 volts), or under adjusted brakes.

There are two synchronization adjustments available:

1. ***System Resistor** - regulates the maximum braking power of the trailer brakes.
2. **Brake Controller** - controls the tow vehicle brake line pressure at which the controller will begin to pass current to the trailer brakes.

***Note:** Electronic brake controller systems now being manufactured have eliminated the need for the System Resistor and are not hooked directly to the tow vehicle's brake master cylinder. Modern vehicles with ABS brake systems do not recommend connecting a hydraulic line to their master cylinder. Please disregard references to the System Resistor if you have an electronic brake controller in this category. Check with your controller installer or the manufacturer if you have any questions about the need for a System Resistor.

Before any synchronization adjustments are made, your trailer brakes should be burnished-in by making 10-12 full stops from approximately 20 mph. This allows the brake shoes and magnets to slightly "wear-in" to the drum surfaces.

AIRSTREAM INTERNATIONAL TRAILER OWNERS MANUAL

TO SYNCHRONIZE:

Start by making sure the trailer brakes are properly adjusted. Set the System Resistor in the middle of the coil and the Controller adjustment near the center of its setting.



WARNING: BEFORE MAKING ROAD TESTS, MAKE SURE THE AREA IS CLEAR OF VEHICULAR AND PEDESTRIAN TRAFFIC.

Make hard stops from 20 mph on a dry paved road free of sand and gravel. If the trailer brakes lock and slide, add more resistance to the circuit with the System Resistor. If they do not slide, take resistance out of the circuit. Adjust the resistor just to the point of brake lockup and wheel skid.

Make a number of 30 mph hard stops to check braking at this speed. Turn the Controller adjustment in the direction for more braking if the trailer brakes lag behind the tow vehicle. If the trailer brakes come in ahead of the tow vehicle brakes, turn the Controller adjustment in the opposite direction. For best braking performance, it is recommended that the Controller be adjusted to allow the trailer brakes to come in just slightly ahead of the tow vehicle brakes. When proper synchronization is achieved there will be no sensation of the trailer jerking or "pushing" the tow vehicle during braking.

When this adjustment is complete, make a hard stop or two from 20 mph to check for wheel lockup and whether further fine-tuning of the System Resistor is required.

GENERAL MAINTENANCE

BRAKE ADJUSTMENT

Brakes should be adjusted (1) after the first 200 miles of operation when the brake shoes and drums have "seated", (2) at 3000-mile intervals, (3) or as use and performance requires. The brakes should be adjusted in the following manner:

1. Jack up trailer and secure on adequate capacity jack stands. Follow trailer manufacturers recommendations for lifting and supporting the unit. Check that the wheel and drum rotates freely.
2. Remove the adjusting hole cover from the adjusting slot on the bottom of the brake backing plate.
3. With a screwdriver or standard adjusting tool rotate the star wheel of the adjuster assembly to expand the brake shoes. (NOTE: With drop spindle axles a modified adjusting tool with an 80 degrees angle should be used. Sears Craftsman # 4736 or K-D #295 is recommended.) Adjust the brake shoes out until the pressure of the linings against the drum makes the wheel very difficult to turn.
4. Then rotate the star wheel in the opposite direction until the wheel turns freely with a slight lining drag.
5. Replace the adjusting hole cover and lower the wheel to the ground.
6. Repeat the above procedure on all brakes.

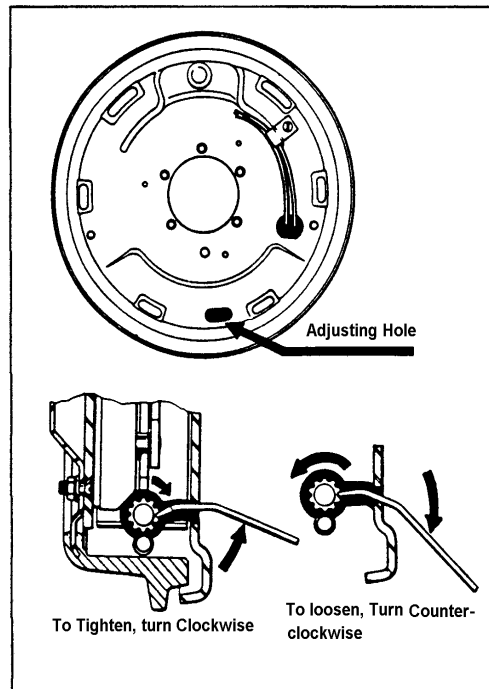

WARNING: NEVER CRAWL UNDER YOUR TRAILER UNLESS IT IS RESTING ON PROPERLY PLACED JACK STANDS.

AIRSTREAM INTERNATIONAL TRAILER OWNERS MANUAL

BRAKE CLEANING, INSPECTION AND LUBRICATION

Your trailer brakes must be inspected and serviced at yearly intervals or more often as use and performance requires. Magnets and shoes must be changed when they become worn or scored thereby preventing adequate vehicle braking.

Cleaning and Inspection

Clean the backing plate, magnet arm, magnet, and brake shoes. Make certain that all the parts removed are replaced in the same brake and drum assembly. Inspect the magnet arm for any loose or worn parts. Check shoe return springs, hold down springs, and adjuster springs for stretch or deformation and replace if required.



WARNING: ASBESTOS DUST HAZARD. SINCE MOST BRAKE SHOE FRICTION MATERIALS NORMALLY CONTAIN ASBESTOS, CERTAIN PRECAUTIONS NEED TO BE TAKEN WHEN SERVICING BRAKES.

1. AVOID CREATING OR BREATHING DUST.
2. AVOID MACHINING, FILING, OR GRINDING THE BRAKE LININGS.
3. DO NOT USE COMPRESSED AIR OR DRY BRUSHING FOR CLEANING. (DUST CAN BE REMOVED WITH A DAMP BRUSH.)

Brake Lubrication

Before reassembling apply a light film of Lubricate or similar grease on the brake anchor pin, the actuating arm bushing and pin, and the areas on the backing plate that are in contact with the brake shoes and magnet lever arm. Apply a light film of oil on the actuating block mounted on the actuating arm.

CAUTION: DO NOT GET GREASE OR OIL ON THE BRAKE LININGS OR DRUMS

MAGNETS

Your electric brakes are equipped with high quality electromagnets that are designed to provide the proper input force and friction characteristics. Your magnets should be inspected and replaced if worn unevenly or abnormally. As indicated in the diagram a straightedge should be used to check wear.

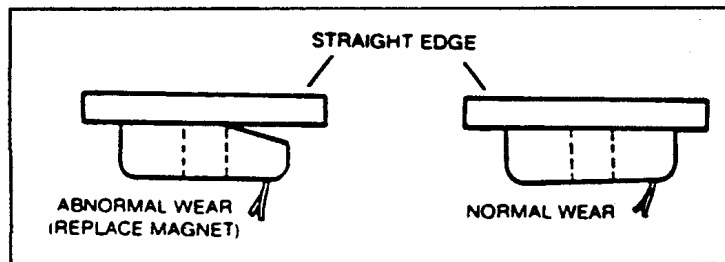

Even if wear is normal as indicated by your straightedge the magnets should be replaced if any part of the magnet coil has become visible through the friction material facing of the magnet. It is also recommended that the drum armature surface be re-faced when replacing magnets. (See Brake Drum Section) Magnets should also be replaced in pairs (both sides of an axle). Use only genuine Dexter replacement parts when replacing your magnets.

AIRSTREAM INTERNATIONAL TRAILER OWNERS MANUAL

SHOES AND LININGS

A simple visual inspection of your brake linings will tell if they are usable. Replacement is necessary if the lining is worn thin (1/16" or less), contaminated with grease or oil, or abnormally scored or gouged. It is important to replace both shoes on each brake and both brakes of the same axle. This is necessary to retain the "balance" of your brakes.

TROUBLE SHOOTING

Most brake malfunctions that cannot be corrected by either brake adjustment or synchronization adjustments can generally be traced to electrical system failures. Mechanical causes are ordinarily obvious, i.e. bent or broken parts, worn out linings or magnets, seized lever arms or shoes, scored drums, loose parts, etc. Electrically, a voltmeter and ammeter are essential for proper troubleshooting

HOW TO MEASURE VOLTAGE

System voltage is measured at the magnets by connecting the voltmeter to the two magnet lead wires at any brake. This may be accomplished by using a pin probe inserted through the insulation of the wires dropping down from the chassis or by cutting the wires. The engine of the towing vehicle should be running when checking the voltage so that low batteries will not affect the readings.

Voltage in the system should begin at 0 volts and as the controller bar is slowly actuated, should gradually increase to about 12 volts. This is referred to as modulation. No modulation means that when the controller begins to apply voltage to the brakes it applies an immediate high voltage, which causes the brakes to apply instantaneous maximum power.

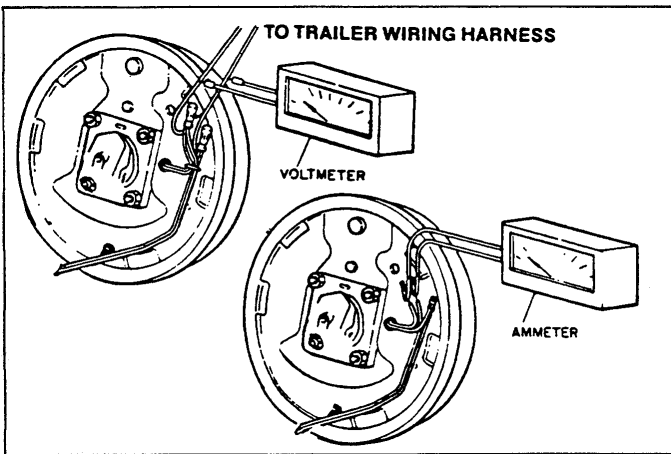

The threshold voltage of a controller is the voltage applied to the brakes when the controller first turns on. The lower the threshold voltage the smoother the brakes will operate. Too high of a threshold voltage (in excess of 2 volts as quite often found in heavy duty controllers) can cause grabby harsh brakes.

HOW TO MEASURE AMPERAGE

System amperage is the amperage being drawn by all brakes on the trailer. The engine of the towing vehicle should be running when checking amperage. One

place to measure system amperage is at the BLUE wire of the controller, which is the output to the brakes. The BLUE wire must be disconnected and the ammeter put into the line. System amperage draw should be as noted in the table following. Make sure your ammeter has sufficient capacity and note polarity to prevent damaging your ammeter. If a resistor is used in the brake system it must be set at zero or by-passed completely to obtain the maximum amperage reading.

AIRSTREAM INTERNATIONAL TRAILER OWNERS MANUAL

Individual amperage draw can be measured by inserting the ammeter in the line at the magnet you want to check. Disconnect one of the magnet lead wire connectors and attach the ammeter between the two wires. Make sure that the wires are properly reconnected and sealed after testing is completed.

By far, the most common electrical problem is low or no voltage and amperage at the brakes.

Common causes of this condition are:

1. Poor electrical connections.
2. Open circuits.
3. Insufficient wire size.
4. Broken wires.
5. Blown fuses. (Fusing of brakes is not recommended).
6. Improperly functioning controllers or resistors.

Another common electrical problem is shorted or partially shorted circuits (indicated by abnormally high system amperage). These are occasionally the most difficult to find.

Possible causes are:

1. Shorted magnet coils.
2. Defective controllers.
3. Bare wires contacting a grounded object.

Finding the system short is a matter of isolation. If the high amperage reading drops to zero by unplugging the trailer, then the short is in the trailer. If the amperage reading remains high with all the brake magnets disconnected, the short is in the trailer wiring.

All electrical troubleshooting procedures should start at the controller. Most complaints regarding brake harshness or malfunction are traceable to improperly adjusted or functioning controllers. See your controller manufacturer's data for proper adjustment and testing procedures. If the voltage and amperage is not satisfactory, proceed on to the connector and then to the individual magnets to isolate the problem source. 12 volts output at the controller should equate to 10.5 volts minimum at each magnet. Nominal system amperage at 12 volts with cold magnets, system resistor at zero and controller at maximum gain should be as detailed in the following chart:

BRAKE SIZE	AMPS/ MAGNET	TWO BRAKES	FOUR BRAKES
10" x 2 1/4"	3.0	6.0	12.0
12" x 2"	3.0	6.0	12.0

NOTE: THESE AMPERAGE LEVELS WILL DROP AS THE MAGNETS HEAT UP.

10" electric brakes are standard on all trailer wheels on the International Trailer Model.

AIRSTREAM INTERNATIONAL TRAILER OWNERS MANUAL

TROUBLE SHOOTING GUIDE

SYMPTOM	CAUSES	REMEDIES
No Brakes	Open circuits Severe under adjustment Faulty controller Short circuits	Find & correct Adjust brakes Test & correct Find & correct
Weak Brakes	Grease or oil on magnets or linings Corroded connections Worn linings or magnets Scored or grooved brake drums Improper synchronization Under adjustment Glazed linings Overloaded trailer	Clean or replace Clean and correct cause of corrosion Replace Machine or replace Correct Adjust brakes Re-burnish or replace Correct
Locking Brakes	Under adjustment Improper synchronization Faulty controller Loose, bent, or broken brake components Out of round brake drums Insufficient wheel load	Adjust Correct Test & Correct Replace components Machine or replace Adjust system resistor and synchronize
Intermittent Brakes	Faulty controller Broken wires Loose connections	Test & correct Repair or replace Find & repair
Brakes pull To one side	Incorrect adjustment Grease or oil on linings or magnet Broken wires Bad connections	Adjust Clean or replace Find & repair Find & repair
Harsh Brakes	Under adjustment Improper synchronization Improper controller Faulty controller	Adjust Correct Change Test & Correct
Noisy Brakes	Under adjustment Lack of lubrication Broken brake components Incorrect brake components	Adjust brakes Lubricate Replace component Correct
Surging Brakes	Grease or oil on linings or magnet Out of round or cracked brake drums Faulty Controller	Clean or replace Machine or replace Test & correct
Dragging Brakes	Over Adjustment Out of round brake drums Incorrect brake components Loose, bent, or broken brake components Faulty breakaway switch Loose wheel hearing adjustment Bent spindle	Readjust Machine or replace Replace Replace Repair or Replace Adjust Replace

AIRSTREAM INTERNATIONAL TRAILER OWNERS MANUAL

HUB REMOVAL

Whenever the hub equipment on your axle must be removed for inspection or maintenance the following procedure should be utilized.

1. Elevate and support the trailer unit per instructions in this manual.
2. Remove the wheel.
3. Remove the grease cap by carefully prying progressively around the flange of the cap. If the hub is an oil lube type then the cap can be removed by unscrewing it counter-clockwise while holding the hub stationary.
4. Remove the cotter pin from the spindle nut.
5. Unscrew the spindle nut (counter-clockwise) and remove the spindle washer.
6. Remove the hub from the spindle, being careful not to allow the outer bearing cone to fall out. The seal will retain the inner bearing cone.

BRAKE DRUM INSPECTION

There are two areas of the brake drum that are subject to wear and require periodic inspection. These two areas are the drum surface where the brake shoes make contact during stopping and the armature surface where the magnet contacts.

The drum surface should be inspected for excessive wear or heavy scoring. If worn more than .020" oversized, or the drum has worn out of round by more than .015", then the drum surface should be turned. If scoring or other wear is greater than .090", the drum must be replaced. When turning the drum surface the maximum re-bore diameter is as follows:

10" Brake Drum- 10.090"

12" Brake Drum- 12.090"

10" electric brakes are standard on all trailer wheels on the Airstream International Model Trailer.

The machined inner surface of the brake drum that contacts the brake magnet is called the armature surface.

If the armature surface is scored or worn unevenly it should be refaced to a 120 micro-inch finish by removing not more than .030" of material. To insure proper contact between the armature face and the magnet face, the magnets should be replaced whenever the armature surface is refaced and the armature surface should be refaced whenever the magnets are replaced.

NOTE: IT IS IMPORTANT TO PROTECT THE WHEEL BEARING BORES FROM METALLIC CHIPS AND CONTAMINATION WHICH RESULT FROM DRUM TURNING OR ARMATURE RE-FACING OPERATIONS. MAKE CERTAIN THAT THE WHEEL BEARING CAVITIES ARE CLEAN AND FREE OF CONTAMINATION BEFORE REINSTALLING BEARINGS AND SEALS. THE PRESENCE OF THESE CONTAMINANTS WILL CAUSE PREMATURE WHEEL BEARING FAILURE.

AIRSTREAM INTERNATIONAL TRAILER OWNERS MANUAL

INTERIOR

The interior of all Airstream trailers has been designed for comfort, convenience, durability and appearance. How you use it and how you take care of it naturally depends on you. However, if you learn to operate the interior components and take care of them and the trailer properly, this knowledge will add to your pleasure as well as the long life of your trailer.

Upholstery

All materials should be professionally dry cleaned to remove any overall soiled condition. However, these materials may be spot cleaned using the cleaning code instructions as listed. Sample swatches are furnished to our dealers. The dealer will be able to give you the name of the fabrics used in your particular trailer. Each swatch will show the cleaning code in parenthesis.

The following are the cleaning code instructions for the various fabrics used in the Airstream trailers:

Code WS

Fabric Care: Spot clean this fabric either with a mild solvent or water based cleaning agent. When using a solvent or dry cleaning product follow instructions carefully and clean only in a well-ventilated room. Avoid any product, which contains highly toxic carbon tetrachloride. You may also use an upholstery shampoo product or the foam from a mild detergent. With either method pretest a small area before proceeding. Use professional furniture cleaner when an overall soiled condition is reached.

Code S

Fabric Care: Spot clean, using a mild water free solvent or dry cleaning product. Carefully follow instructions on such product. Clean only in a well-ventilated room. Avoid any product containing carbon tetrachloride, which is highly toxic. Pretest small area before proceeding. Use professional furniture cleaner when an overall soiled condition is reached.

Code W

Fabric Care: Spot clean, using the foam only from water based cleaning agent such as mild detergent or non-solvent upholstery shampoo product.

Apply foam with a soft brush in a circular motion. Vacuum when dry. Pretest small area before proceeding. Use professional furniture cleaner when an overall soiled condition is reached. The manufacturer of the fabric designed the above code.

CAUTION: Never remove cushion cover for separate dry cleaning or washing. Any tumble cleaning method can destroy the backing, shrink or otherwise damage upholstery fabric.



WARNING: Keep your furniture and family safe from fires caused by careless smoking. Do not smoke when drowsy. Remove immediately any flowing ash or a lighted cigarette, which falls on furniture. Smoldering smoking material can cause upholstered furniture fires.

Draperies

CAUTION: All drapery materials and mattress covers must be professionally dry-cleaned.

Unsnapping from the wall, removing a screw or pop rivet from the end of the curtain track, and sliding them out remove draperies. The pop rivets are removed by drilling through the head with a 1/8" drill bit.

To prevent damage to the draperies while traveling, the VENETIAN TYPE BLINDS should be lowered, secured at the bottom and the slats turned vertically.

AIRSTREAM INTERNATIONAL TRAILER OWNERS MANUAL

Wall covering

For general dirt and grime spots, sponging with the foam from a mild detergent or upholstery shampoo should remove the accumulated dirt and grime spot. Oxy-clean cleaning solution will work for most spot applications. Rinse well with a clean sponge to remove traces of the water based cleaning solution. Oil or grease spots will respond to mild solvent or dry-cleaning agents. Follow directions carefully and use only in a well-ventilated area. Do not rub excessively. Try the blot method to prevent the fabric from fuzzing. To prevent overall soiling, frequent vacuuming or light brushing to prevent dust and grime is recommended. When an over-all soiling condition is reached, use a professional furniture cleaning service.

Carpet

The carpet can be cleaned with any good commercial carpet cleaner, or with a detergent and water. BE CAREFUL NOT TO SOAK THE CARPET WITH WATER.

Vinyl Floor

The vinyl floor in your unit can be cleaned with liquid floor cleaning solutions recommended for vinyl floors and warm water.

Counter Area

The counter areas around the sink are of a high-pressure laminate and can be cleaned with soap and water, or you can use a common solvent on tough spots. Be sure no abrasive cleaner is used, as there is the possibility it could scratch the surface. A protective pad should always be placed under hot utensils.

Sinks

Cleaning can be accomplished using mild liquid detergent with a soft cloth. A complete Home Owners Guide for your sinks is supplied in your Owner's Folder. Please read these instructions before use.

Shower Stall

To clean your fiberglass shower stall unit use warm water and one of the stronger liquid detergents. Do not use abrasive cleaners, they may scratch and dull the surface of your fiberglass unit. Stubborn stains can be removed with solvents such as turpentine, paint thinner or acetone. Restore dulled areas by rubbing with an automotive type liquid cleaner then put the soft glow back into your fiberglass unit with a light application of liquid wax. Chips and gel-coat cracks can be repaired. Check with local repair shops or your dealer for this service.

Dinette

The dinette is made into a bed by rising up on the front of the table and folding the table leg up against the bottom of the leaf. As the table is raised it will unhook from the upper wall brackets. Once it is unhooked it can be pulled out and the wall hinge will let it be lowered on the supports of the dinette seats. The backrests of the seats are placed over the table to complete the conversion.

Metal Interior Skin

The interior shiny metal skin is the same as the exterior skin on your trailer. The cleaning and care would be the same. Use common sense on the waxing and washing on the interior. A damp soft cloth will do most of the time.

CAUTION: ABRASIVE POLISHES OR CLEANING SOLVENTS SUCH AS AUTOMATIC DISHWASHER OR ACID ETCH CLEANERS ARE TOO STRONG AND SHOULD NEVER BE USED. RINSE ALL GRIT FROM SURFACE PRIOR TO WASHING. Use soft rags or wash mitts always moving lengthwise with the trailer. NEVER rub hard on the coating. Even the softest rag will damage the coating if excessive pressure is applied.

AIRSTREAM INTERNATIONAL TRAILER OWNERS MANUAL

Central Control Panel

The SeeLevel Control panel monitors the 3 holding tanks, showing the percent water or sewage level on a digital LED display with an accuracy of +/-2%. In addition, the system can display the operating characteristics of each of the tank sending units, giving it unsurpassed diagnostic capability.

Battery voltage is displayed with an accuracy of +/- 0.1 volts, and the display contains a switch to control the fresh water pump. The battery condition tester, used when not plugged into 110-volt power, will indicate whether the trailer batteries are in good, fair or poor condition. When they show weak or bad condition you should take every reasonable step to conserve power by using as few lights as possible and switching off appliances. The battery should be charged as soon as practical with the tow vehicle charging system, or by connection to 110-volt power.

Further information and instructions are available on this system in the electrical section of this manual under monitor panel and a complete manual is included with this packet..

Water Heater Switch

The water heater switch with a red indicator light is for lighting the water heater and is located on the rear galley rooflocker on the AS 22Ft. and on the CS wall above the rear desk on the 22 Ft. CCD models.

Water Pump Switch

The water pump switch is located on the monitor panel that is mounted on the galley roof locker on the 22 Ft AS model and on the CS wall above the rear desk in the 22 Ft. CCD models. Once the switch is turned on the pump will run until the water pressure reaches about 65 psi. At this point an internal pressure switch will shut it off. When a faucet is opened the water pressure will drop and the pump will start to run again. The water pump should be turned off when the trailer is left unattended and when city water is being used as the fresh water supply.

Bathroom Exhaust Fan

The bathroom exhaust fan is in the bathroom ceiling and is opened by pushing up on the handle running across the fan opening.

Shower Head

The lavatory sink spout pulls out for the showerhead. It is designed to give maximum flexibility in usage, and provides for water saving techniques when using your trailer on self-containment. It can be held in the hand and moved about the body. Normally the best water conservation procedure is to wet the entire body and then turn the water off. Apply soap, lather thoroughly, and then rinse the soap off. The telephone showerhead is also used to fill the tub for taking a bath.

Ceiling Light Fixtures

On the AS model the ceiling light fixture has a high-low switch located in the center of the fixture. Wall switches are located beside the bed under the credenza a 3-gang wall switch just inside the door controls the ceiling, patio, and galley lights. The reading and galley lights are all individually switched. Gently squeezing in the middle of the ceiling light fixtures and pulling down will remove the LENS. During cold weather it is a good idea to leave the light on a few minutes prior to removing the lens.

On the CCD model indirect, patio, and dinette light switches are located by the main door. Galley, shower, and another indirect lighting switches are located in the galley area.

AIRSTREAM INTERNATIONAL TRAILER OWNERS MANUAL

Battery Disconnect Switch

The disconnect switch is used to separate the battery from the 12-volt distribution panel and converter charging system.

When the disconnect switch is turned to “**use**” (on) and the trailer is plugged into a 110-volt shoreline, the 12-volt distribution panel will receive power from the converter as the battery is charged through the converter charging system. If the trailer is not plugged into a 110-volt shoreline, the battery will supply 12-volts to the trailer and no charging to the battery is available since the converter is not receiving 110-volt power.

When the disconnect switch is turned to “**store**” (off) and the trailer is plugged into a 110-volt shoreline, the 12-volt distribution panel will still receive power from the converter, but the battery is disconnected from the system. The battery will not be drained with the switch in the “**store**” position. The converter will not charge the battery with the switch in the “**store**” position either.

The charge in the 12-volt batteries is replenished when towing from the tow vehicle alternator through the 7-way cord. This charge will go to the battery no matter which position the Battery Disconnect Switch is in.

Fresh Air Vents

A control handle operates the ceiling fresh air vents. Turning clockwise will raise the vent. Check your lid gaskets once a year.

Information on the front high volume roof vent may be found in the appliance section of this book.

Storage

All cabinets and storage areas should have the heaviest items on the bottom and lighter items overhead. After loading you should have the skillet and can goods on the floor or bottom shelf, and the cereals and crackers in the overhead rooflocker. Use the unbreakable type plates and saucers, and consider storing your dishtowels around them. Better yet, use paper plates. Who wants to wash dishes when on a trip or vacation?

Clothes hung in wardrobes should be kept on hangers that snap over the clothes rods to keep them from "jumping" off on rough roads. Evening dresses should be kept in the plastic bags like dry cleaning businesses use. No matter how hard you try, if you travel a long dusty section of road the dust will work its way into the trailer and soil clothes. Try to avoid large bulky coats. Layers of lighter clothing will usually keep you warmer, are more versatile and easier to store.



WARNING: Keep flammable material away from the furnace.

Remember, heavy items should be stored low and toward the front, lighter items in the rear and overhead cabinets.

AIRSTREAM INTERNATIONAL TRAILER OWNERS MANUAL

SMOKE ALARM - FIREX MODEL B

Maple Chase Company
2820 Thatcher Road
Downers Grove, Illinois 60515-4040

IMPORTANT INFORMATION-SMOKE ALARM SAFETY CHECKLIST

1. Test your smoke alarm every week. To test the electronics, firmly depress the button. To test that smoke reaches the sensor, blow smoke in a careful fire-safe manner into your smoke alarm.
2. Your smoke alarm will not work without power. Never shut off its power or remove the battery to quiet the alarm. **FOR BATTERY-POWERED UNITS:** When your smoke alarm "beeps" about once a minute, the battery is weak. Immediately install a new battery correctly. Be sure to use only batteries specified in Owner's Manual or on unit. Test unit after installing a new battery.
3. Clean and vacuum the openings on your smoke alarm once a month.
4. Do not open the smoke alarm or try to repair it. For replacement information see the **WARRANTY** in the Owner's Manual.
5. Verify you have the proper number of smoke alarms in your home and the correct location for each one. A smoke alarm will not respond well in an incorrect location.
6. If your smoke alarm has one or more of these special features, please note:
 - **FALSE ALARM CONTROL (Model C):** Pushing test/hush button reduces sensitivity for up to 15 minutes, minimizing nuisance alarms,
 - **FLASHING LIGHT (Model E):** Pushing test button turns flashing safety light on. Very thick smoke may obscure light.
7. Smoke alarms have technical limitations and may not respond in all situations. **FIRE PREVENTION** is your best safeguard.
8. For a replacement Owner's Manual or Safety Checklist, please indicate your unit model, include a self-addressed stamped envelope and send to:

WEEKLY TESTING OF YOUR SMOKE ALARM

1. **FOR A COMPLETE WEEKLY TEST OF THE ELECTRONICS AND THE SENSOR OPERATION, FIRMLY DEPRESS THE TEST BUTTON ON THE COVER OF THE SMOKE ALARM FOR A FEW SECONDS.** The smoke LED (light emitting diode), which is the indicator light under the clear Push-to-Test button, will blink once per second while the button is being pushed and the alarm is sounding. The smoke alarm will stop sounding when you release the button.
2. If your smoke alarm has the False Alarm Control or Safety Light feature see "SPECIAL SMOKE ALARM FEATURES" for further testing information.
3. **IMPORTANT:** Always test your smoke alarm upon returning from vacation, or any other time when no one has been in your household or residence for several days.
4. If a smoke alarm is installed in a mobile home, test the smoke alarm after you remove the vehicle from storage and before each trip.



WARNING: If your smoke alarm does not respond as described in any of the above tests, check that a good battery is properly installed. If a good battery is properly installed, promptly remove the unit, repack it and return it for repair or replacement.

AIRSTREAM INTERNATIONAL TRAILER OWNERS MANUAL

TAKING CARE OF YOUR SMOKE ALARM

Your smoke alarm has been designed and manufactured to be as maintenance-free as possible. Here are a few simple steps you must perform, in addition to the weekly tests described in the section "WEEKLY TESTING OF YOUR SMOKE ALARM," to keep your unit in good working order.

- The smoke alarm should be vacuumed monthly or more often if there is dust, dirt or kitchen grease that can accumulate. Use a soft brush or wand attachment and vacuum all slots in the cover and side. **FOR YOUR SAFETY**, you must properly clean and maintain your smoke alarm, since a dirty or malfunctioning unit may fail to alarm or cause unwanted nuisance alarms.
- If the unit is damaged or fails to operate properly, and you have checked that a good battery is installed correctly, follow the directions in the section "WHERE TO SEND YOUR SMOKE ALARM IF IT NEEDS SERVICE" for return. **FOR YOUR SAFETY, DO NOT OPEN THE SMOKE ALARM AND TRY TO REPAIR IT YOURSELF.** While smoke alarms are economical devices, they contain precision electronic components that are precisely calibrated. The manufacturer must do repairs.

REPLACING THE BATTERY

The smoke alarm will "beep" once a minute for at least 30 days when the battery is weak. The battery must **immediately** be replaced with a fresh one.

The battery should also be changed if it does not sound an alarm when tested. **TO REPLACE THE BATTERY:**

1. Check if the tamper resist locking pin is installed in the smoke alarm (see "USING THE TAMPER RESIST LOCKING MECHANISM" section). If so, pull the pin completely out of the smoke alarm using long-nose pliers.
2. Remove the smoke alarm from the mounting bracket by twisting counterclockwise
3. Replace old battery with a fresh one. If your smoke alarm has a safety light, the miniature lamp operates on two AA batteries. (See recommended batteries below.)
4. Check that battery connections are secure and the battery is secured in its compartment
5. Test smoke alarm for proper operation (see "WEEKLY TESTING OF YOUR SMOKE ALARM" section). The smoke alarm operates on a 9-volt battery. The normal battery operating life will be one (1) year. The life of some batteries may be less.
6. Firex smoke alarms sold with Ultralife long-life lithium batteries require replacement approximately every ten (10) years or when the low battery signal sounds.

CAUTION: You should only use the batteries specified here or on the label of the unit.

AIRSTREAM INTERNATIONAL TRAILER OWNERS MANUAL

For Models A, B, C, E and PB use: Eveready 216, 522 or 1222; Mallory MN1604; Duracell MN1604; or Ultralife U9VL-J.

For Model E also use AA Heavy Duty for light power. The miniature lamp operates on two (2) AA batteries. For replacement, use heavy-duty or alkaline AA batteries: Eveready 1215, E91, or Duracell M15HD, MN1500.

CAUTION: Do not use any type of rechargeable batteries.

USING THE TAMPER RESIST LOCKING MECHANISM

To make the smoke alarm somewhat tamper resistant, a "locking pin" has been provided in the base of the unit. It will help deter a child or other individual from removing the smoke alarm from the bracket. See Figure 7. The following directions can install this.

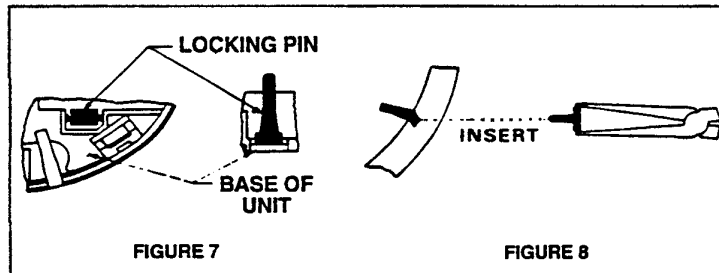

1. Remove the breakaway locking pin from the unit by rocking pin back and forth.
2. Put the smoke alarm back on the mounting bracket. (See section "HOW TO INSTALL YOUR SMOKE ALARM.")
3. Using long-nose pliers grab the head of the locking pin and insert into hole located on the side of the smoke alarm. See Figure 8.
4. The Tamper Resist feature is now installed and complete.

To Remove:

5. Using long-nose pliers grasp the head of the locking pin and pull the pin completely out of the smoke alarm.
6. The smoke alarm can now be removed from the mounting bracket with a counterclockwise twist.

SPECIAL SMOKE ALARM FEATURES

If your smoke alarm has one or more of these special features, read the following:

- **BLINKING LED LIGHT** (Models B, C, E and PB): The indicator light under the Push-to Test button blinks about once per minute to indicate the smoke alarm is receiving power.



WARNING: Very thick smoke may obscure the light.

AIRSTREAM INTERNATIONAL TRAILER OWNERS MANUAL

LP GAS DETECTOR

The LP gas detector is located approximately six inches above the floor. LP gas is a mixture of gases produced and sold commercially as a fuel for heating and cooking appliances. LP gas is highly flammable and, as a result, can be explosive if ignited under certain circumstances. LP gas is heavier than air and, if confined in a closed space, will accumulate close to the floor. When the LP gas concentration in your unit exceeds 2000 PPM the detector will provide a visual and audible alarm by sounding a buzzer and flashing the red LED two times per second.



WARNING Activation of this detector indicates the presence of LP gas, which can cause an explosion and/or fire. This normally indicates a leak in the LP gas installation or a LP gas appliance. Extinguish all open flames, open your windows and door and evacuate the unit immediately. Do not activate any electrical switch. Turn off the LP at your gas bottle(s). **DO NOT RE-ENTER YOUR UNIT UNTIL A QUALIFIED REPAIR TECHNICIAN HAS CORRECTED THE PROBLEM OR A FIRE DEPARTMENT OFFICIAL HAS CLEARED YOUR UNIT AS SAFE.**

OPERATION

Your LP gas detector is wired directly to your vehicle battery and incorporates a 1-amp in-line fuse. When the device is operating normally the green LED will be lit.



WARNING It is not recommended that the detector be disconnected from the battery during periods of storage. There is a small heater on the sensor of the device, which "burns" away impurities in the air during periods of normal use. During periods when power is interrupted, impurities can build up on the sensor. When power is returned to the detector the detector alarm may activate until the impurities are "burned" off. This could take a number of hours, during which time the alarm will be constantly "on".

DETECTOR TEST

Press the test button for 5 to 6 seconds until the alarm sounds then release the test button. The red LED should flash and the alarm sound for approximately 4 minutes. This test should be performed at least once a week during normal vehicle operation, and after periods of storage, and before each trip.

LOW VOLTAGE

Below 10 VDC the detector will continue to operate but will blink alternately green and orange. Below 8 VDC the unit will behave erratically and will eventually shut off. To ensure proper operation, do not operate the unit below 10 VDC.

COMPONENT FAILURE

The failure of any circuit component will cause the detector to display a continuous orange LED fault light and a short beep indicating failure. If this occurs, immediately contact your dealer or Airstream Customer Service for the name of the nearest detector service center.

Please read the operating instructions for your detector, which have been supplied with the paper work of your unit.



WARNING: Have a professional check your system if you have any doubts.

AIRSTREAM INTERNATIONAL TRAILER OWNERS MANUAL

FIRE EXTINGUISHER

The fire extinguisher should have the charge checked on a regular basis. Make sure your family, especially the cook, knows how to release the extinguisher storage bracket, and how to properly operate the extinguisher. If you find the directions on the extinguisher unclear, check with your local fire department for professional advice on its operation and use. We're sure they will be happy to assist you and your family.

SAFETY: Many things can be construed as safety related, but the most important is your common sense. If you are careless with matches, cigarettes, flammable material or any other hazardous material, we are sure you realize your potential for accidents is greatly increased.

EXTERIOR WINDOWS

The windows in your trailer are safety glass. To open: release the two lever locks at the bottom, lift up on the two side operator handles until the window is in the desired position, and place the operators into one of three positioning slots on the side of the frames. To lock the windows, reverse this procedure.

 **WARNING:** The escape windows(s) are identified by red release handles and are opened by lifting up both latches, then turning the latches toward the center. Push out on the glass and it will swing clear. The window operation should be checked each trip and the latches lubricated with WD-40 or equivalent every six months. A loop is provided in the SCREEN RETAINING SPLINE so it can be rapidly removed. Take hold of the loop and pull the rubber spline out of the screen frame. The window screen can then be easily pushed out.

 **WARNING:** Check the emergency escape route outside your escape window at every stop. At each campsite make sure you have not parked in such a manner as to block the operation of the escape window by being too close to trees, fences or other impediments. Scenic views are one reason for traveling, but don't park so the beautiful lake or steep cliff is just outside your escape window. Never park your trailer so the escape windows cannot be easily used for emergency exits.

 **WARNING:** You and all your family should practice escape procedures so they can be rapidly accomplished even in total darkness. Never block the interior or exterior access to the emergency escape windows.

These windows are cleaned in the same manner that ordinary windows are. Clean the seals with a damp cloth or mild detergent every three to six months, taking care not to use a strong solvent, as it will damage the seals. A coat of natural silicone lubricant applied after the seal has dried will keep it flexible. Spread the lubricant evenly with a brush or finger, working it into the surface. This is a good practice for all rubber seals in your Airstream. For replacement of a damaged window contact an Airstream Service Center or the factory.

SCREENS

Your plastic screens are easy to maintain. Just clean them occasionally with a damp cloth.

Note: They will melt at the point of contact if touched by a cigarette.

AIRSTREAM INTERNATIONAL TRAILER OWNERS MANUAL

NOTES

AIRSTREAM INTERNATIONAL TRAILER OWNERS MANUAL

PLUMBING SYSTEM

LIQUID PETROLEUM GAS (LPG)

FILL VALVE

Your trailer is equipped with LP tank fill valves called "RV Type I Acme" connection. The large, green, nylon swivel nut is a right hand thread and is designed for **hand operation only**.

The valve features an internal spring-loaded module that will not allow gas to flow from the cylinder until a positive seal has been made at the connection. The valve outlet has 1-5/16" Acme threads on the outlet exterior and female POL, left-handed threads on its interior. This feature allows for connection of the new wrenchless, right-handed, Acme RV connection and still accommodates the standard left-handed POL fittings used for filling propane cylinders.

The mating, green swivel nut and brass nipple also incorporates new features: the green nylon nut swivels on a black bushing that is heat sensitive. Between 240 degrees F and 300 degrees F the bushing will yield (melt) allowing the spring-loaded module in the valve to push the brass nipple back (approximately 1/4") closing the module and stopping the flow of gas from the cylinder. Inside the brass nipple is a flow-limiting device designed to sense excessive gas flow. If an excessive flow is sensed, the flow-limiting device shuts the flow down to a maximum of 10 SCFH (Standard Cubic Feet per Hour) or less. This is also referred to as the by-pass flow.

By-pass flow is extremely important in the proper operation of this connection. The flow-limiting device may activate if the cylinder valve is opened quickly. When all appliances are off, the by-pass flow allows the pressure downstream from the flow-limiting device to equalize. When pressure is equalized, the flow-limiting device will supply normal flow to the system. Equalization occurs in approximately 5 seconds and in most cases goes completely unnoticed. If, however, an appliance is left on or there is a leak or open flow in the system, the by-pass pressure will not be able to equalize and allow the flow-limiting device to re-open. Symptoms of this condition would be appliances that light but have lower than normal flame or starve out from lack of gas, a substantial reduction in the flame when another appliance is operating, or pilots that are difficult to light. If this should happen, the following steps should eliminate the condition:

1. Close LP cylinder valve.
2. Extinguish all flames and smoking materials
3. Be sure all gas appliances, including their pilot lights, are off.
4. Open LP cylinder valve slowly. **DO NOT SNAP OPEN.**
5. Wait at least 15 seconds before lighting appliances.
6. If operational difficulties continue, there may be a leak in the system. Immediately close the LP cylinder valve and have the system inspected by a qualified RV service technician.

Again, make sure all appliances are off before opening propane cylinder valves.

Exception: when reconnecting a full cylinder to an auto changeover regulator it is not necessary to shut off the appliances or close the valve of the cylinder already in service.

 **WARNING: LEAKING LP GAS MAY IGNITE CAUSING A FIRE OR EXPLOSION WHICH COULD RESULT IN SERIOUS BODILY INJURY, PROPERTY DAMAGE, OR DEATH.**

How long a full tank of gas will last is dependent on usage. In cold weather, when you are using the furnace, large amounts of hot water, and are doing extensive cooking, you will naturally use more than you will in warm weather when you may do limited cooking. On the average, with normal cooking and other appliance use you can probably count on two to three weeks of service from each tank.

AIRSTREAM INTERNATIONAL TRAILER OWNERS MANUAL

AUTOMATIC GAS REGULATOR

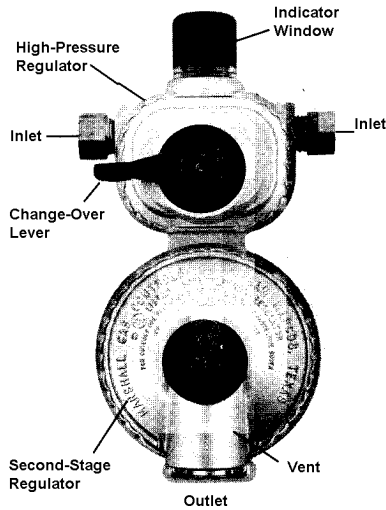

All models are equipped with an automatic gas regulator. Both tanks are connected to this regulator.

When the gas is turned on it is drawn from only one tank at a time. When the tank being used is depleted the regulator automatically switches to the full tank. An indicator in the regulator knob points toward the tank that was being used to give you a visual reminder when one tank is empty.

Operation

Make sure there is propane in both cylinders before you start. Rotate the black lever on the top front side of the regulator toward the cylinder you want to use first. This will be the “service” cylinder and the other will be the “reserve” cylinder. Slowly open both tank valves completely, then close about 1/4 turn. This will allow you to easily check to see if valves are open or closed. The indicator on the top of the regulator will turn bright green. The indicator color will stay green as long as there is fuel coming from the service side. When the service cylinder empties, the regulator will start drawing from the reserve cylinder providing an uninterrupted fuel flow to the system. When it switches over, the indicator color changes from green to red. This red color indicates that the service cylinder is empty and needs to be filled.

Now disconnect the cylinder and have it refilled. After filling, reconnect the pig-tail and slowly open the cylinder valve. The full cylinder now becomes the reserve.

LPG BOTTLES

The following step-by-step procedure gives you the proper method of removing and installing these bottles:

1. Rotate the black lever all the way over towards the reserve cylinder. The indicator will turn green and the reserve cylinder becomes the service cylinder. Now shut off the cylinder valve on the empty cylinder.
2. Disconnect the green swivel nut from the cylinder valve at the bottle to be removed. (This fitting has a common right hand thread and turns in the same direction to most threaded fittings.)
3. Turn the large clamping "T" handle counterclockwise until the hold down bracket is loose enough to remove the bottle. If your trailer is equipped with a gas bottle cover the "T" handle must be removed, and then remove the cover before removing the bottle.

DO NOT REMOVE THE CENTER HOLD DOWN ROD!

To Install

1. Place the bottle in position on the "A" frame and bottle cross member so that it rests on the upper collar of both bottles with the collar rims engaged in the grooves on the underside of the bracket. If your trailer is equipped with a gas bottle cover it should be positioned over the bottles next. Make sure the hold down rod projects up through the hole in the shroud center bracket.
2. Replace the "T" handle and tighten down until the bottles are held firmly in place.
3. Hand-tighten the green nylon swivel nut onto the tank valve outlet.
4. Turn on gas shut off valves and test all fittings with a soap suds or detergent solution and watch for bubbles.

AIRSTREAM INTERNATIONAL TRAILER OWNERS MANUAL

LIQUID PETROLEUM GAS (LPG)



WARNING: LP gas regulators must always be installed with the diaphragm vent facing downward. Regulators that are not in compartments have been equipped with a protective cover. Make sure that regulator vent faces downward and that cover is kept in place to minimize vent blockage, which could result in excessive gas pressure causing fire or explosion.

CAUTION: The LPG bottles are securely mounted on the front "A" frame of your trailer. If these bottles must be removed for service or replacement it is important that they be reinstalled correctly in order to prevent any possibility of their falling off or becoming dislodged during travel.



WARNING: Your LP tanks must be filled as directed by the tank manufacturer. Instructions are located on a decal near the fill valve. The decal must not be defaced.



WARNING: Your LP tank must be, and can only be, placed in the proper position when remounting on the front of the trailer. In any other position the base of the tank will not fit into the recess.



WARNING: Use only the gas bottles furnished with your trailer. If replacement is required it must be a bottle of the same size and design.



WARNING: The vent at the bottom of the regulator must be kept free of any obstructions and must be pointed downward. A good habit is to check the vent each time a bottle is removed for filling. It is especially important to check the vent if the trailer has not been used regularly.

Twice a year, or after a long storage period, we suggest you take your unit in for a checkup and cleaning of the gas operated appliances.

AIRSTREAM INTERNATIONAL TRAILER OWNERS MANUAL

LIQUID PETROLEUM GAS (LPG)

BASIC RULES FOR SAFETY



WARNING: Do not store LP containers within a vehicle. LP containers are equipped with safety devices that vent gas should the pressure become excessive.



WARNING: Do not use cooking appliances for comfort heating. Cooking appliances need fresh air for safe operation. Before operation open an overhead vent or turn on an exhaust fan and open a window.

A warning label has been located in the cooking area to remind you to provide an adequate supply of fresh air for combustion. Unlike homes, the amount of oxygen supply is limited due to the size of the recreational vehicle; and, proper ventilation when using the cooking appliances will avoid dangers of asphyxiation. It is especially important that cooking appliances not be used for comfort heating as the danger of asphyxiation is greater when the appliance is used for long periods of time.



WARNING: Portable fuel burning equipment, including wood and charcoal grills and stoves, shall not be used inside the recreational vehicle. The use of this equipment inside the recreational vehicle may cause fires or asphyxiation.



WARNING: A warning label has been located near the LP gas container. This label reads: **DO NOT FILL CONTAINER (S) TO MORE THAN 80 PERCENT OF CAPACITY.**

Overfilling the LP gas container can result in uncontrolled gas flow, which can cause fire or explosion. A properly filled container will contain approximately 80 percent of its volume as liquid LP gas.



WARNING: Do not bring or store LP gas containers, gasoline or other flammable liquids inside the vehicle because a fire or explosion may result.



WARNING: IF YOU SMELL GAS:

1. Extinguish any open flames, pilot lights and all smoking materials.
2. Do not touch electrical switches.
3. Shut off the gas supply at the tank valve(s) or gas supply connection
4. Open doors and other ventilating openings.
5. Leave the area until odor clears.
6. Have the gas system checked and leakage source corrected before using again.

AIRSTREAM INTERNATIONAL TRAILER OWNERS MANUAL

LPG System

22 Ft. International & CCD LPG Layouts

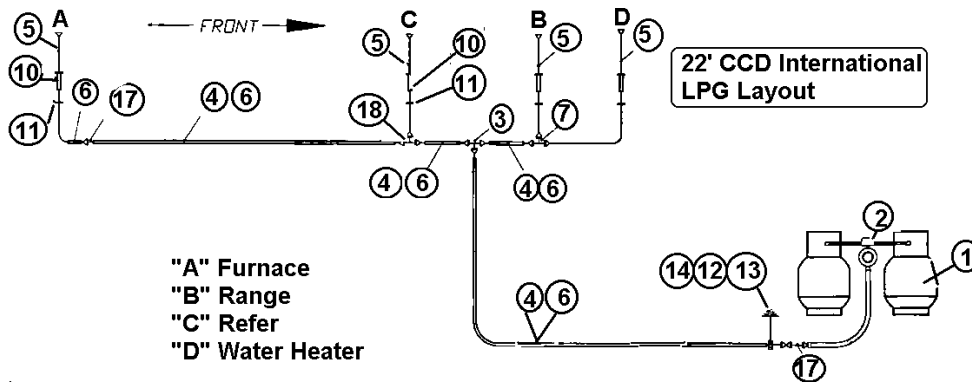
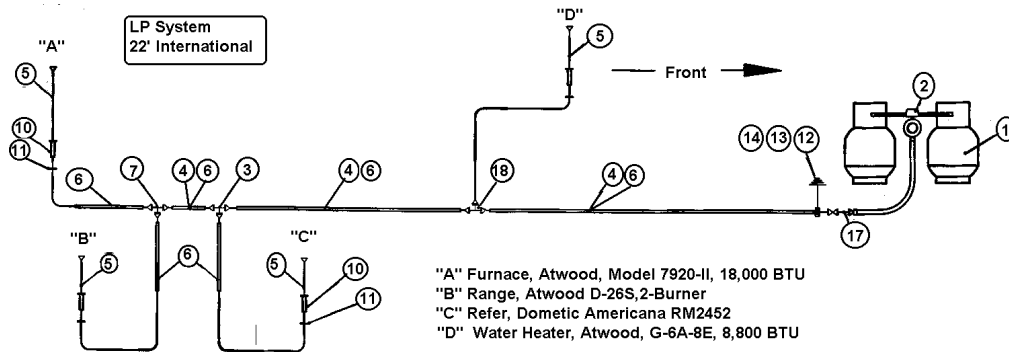

- | | |
|----------------|--------------------------------------------|
| 1. 601781 | 20# steel cylinder w/outlet valve |
| 2A. 601384 | LP regulator, Manchester #17632 |
| 2B. 601686 | Base Plate |
| 2C. 601687 | Hold down kit |
| 2D. 601412-012 | Connector-M, .50" pipe to .62" tube |
| 2E. 601685-01 | LP hose, 1/2" FPT x 3/8" FL x 36 USA |
| 2F. 601685-02 | LP hose, 1/2" FPT x 3/8" FL x 36 CSA |
| 2G. 381613 | Cover, LP wing handle |
| 3. 601281 | 5/8" x 5/8" x 5/8" Brass Union Tee |
| 4. 600004 | Copper tubing, 5/8" ID |
| 5. 600008 | Copper tubing, 3/8" ID |
| 6. 601159-02 | Tubing cover, .50" Poly, CSA approved |
| 7. 600003 | Tee, 5/8" x 3/8" x 3/8" |
| 8. 600436 | Forged flare nuts, 5/8" |
| 9. 600435 | Forged flare nuts, 3/8" |
| 10. 380887 | Floor grommet |
| 11. 380886 | Floor grommet |
| 12. 600661 | Grounding clamp, 1/2 to 1 |
| 13. 500839 | Copper wire, bare, 8 ga, |
| 14. 500038 | Lug, ground |
| 15. 345004 | Screw, 1/4-14 Washer Hex-head, (not shown) |
| 16. 340085-05 | Clamp, #Coy, 5/8" diameter (not shown) |
| 17. 601734 | Fitting, brass 5/8" OD flare x 1/2" |
| 18. 600000 | Tee, brass 5/8" x 5/8" x 3/8" |

AIRSTREAM INTERNATIONAL TRAILER OWNERS MANUAL

WATER SYSTEM-SELF CONTAINED

Fill the water tank by opening the exterior access door and remove screw cap. A garden hose can now be inserted. It's a good idea to let the water run through the hose for a short time to flush it out. Experienced RVers usually fill their tanks with "home" water to avoid strange water that may be distasteful to them.

The amount of water in the tank may be checked on the Monitor Panel, or you may fill the tank until water overflows out of the fill.

Turn water heater by-pass valves, located under the roadside wardrobe hinged bottom shelf on the CCD unit and under roadside hinged front dinette seat on International on the water heater, to normal flow position. Normal flow position is: shut off valve B - open valves A and C. In some models the valves may be in a horizontal pattern or on top of the heater, rather than the vertical shown in the illustration. Valve operating sequence will be the same

Open the hot side of the galley or lavatory faucet and turn on the water pump switch located on the monitor panel. For some time the open faucet will only sputter. This is because the water heater is being filled and air is being pushed out through the lines. Once the water heater is full a steady stream of water will come from the faucet. Now open a cold faucet. It will sputter for a short time, but will soon expel a steady stream. All other faucets can now be opened until all air is expelled. Once the system is filled with water and the faucets closed, the water pump will shut off. When a faucet is opened the pump will come back on automatically. If the faucet is just barely open it is normal for the pump to cycle on and off rapidly.

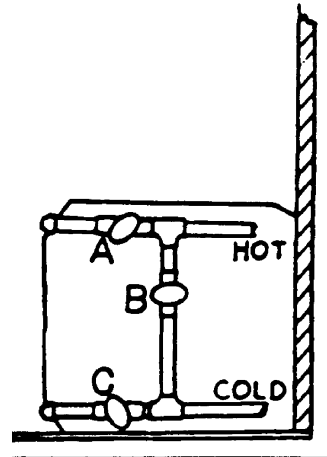

CAUTION: The water pump must be turned off when hooked up to city water supply and when you leave your Airstream unattended.

WATER PUMP AND STRAINER

The water pump and strainer are located in the curbside wardrobe on all models.

To clean strainer screen, first remove inlet connection from the pump side of strainer. This will allow the intake side of the strainer to be rotated about 1/8 turn counter clockwise and be removed. The screen part of the strainer will now be accessible for cleaning.

When reassembling only rotate the inlet side of the strainer until the stops are felt. The "O" ring performs sealing and too much pressure will only break the strainer.

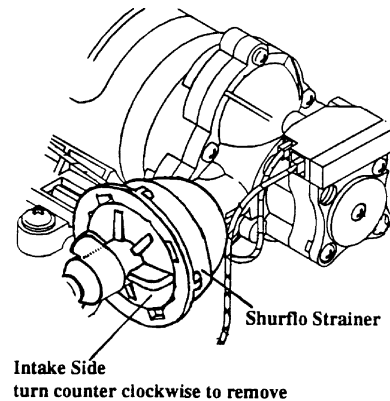

AIRSTREAM INTERNATIONAL TRAILER OWNERS MANUAL

WATER PUMP

Manufacturer:

Shur-Flo
1740 Markle Street
Elkhart, Indiana 46514
Phone: 219-294-7581

088-404-144 PUMP REPAIR KITS

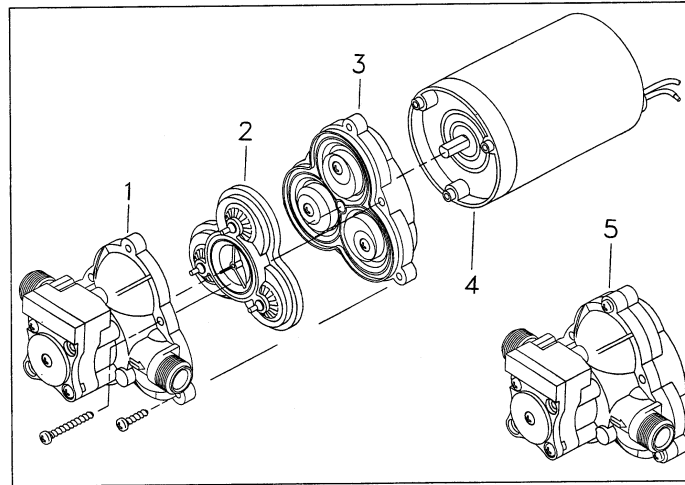

1. Switch/check valve and upper housing kit (replaces all previous switch designs)
2. Valve plate assembly
3. Diaphragm/drive assembly
4. Motor
5. Complete Pump Head assembly (includes 1,2,3) (replaces all previous switch designs)

Switch and Check Valve Repair

The check valve, hydraulic switch mechanism and micro switch are accessible by removing the switch cover.

CAUTION: Care should be taken in removing the switch cover screws. Within the mechanism is a spring under compression.

AIRSTREAM INTERNATIONAL TRAILER OWNERS MANUAL

Replacement of Micro Switch

Occasionally the micro switch fails or an electrode is broken off. Proceed as follows: Remove the two screws holding the cap to the main body. Remember, this cap retains a spring under compression. With both screws out, allow the spring to extend fully. Then carefully lift off cap and spring. If only the micro switch is at fault, avoid disturbing the hydraulic elements remaining in the head. If examination of the hydraulic parts is required, remove them carefully by pulling. Be sure to note the order of removal.

To replace the micro switch, remove the spring and pull out the black retaining ring. This will allow the micro switch to fall free. Replace parts in the reverse sequence: Micro switch, black retainer, and the spring.

Reassemble cover to the main body. Switch cap may be pointed up or down as desired, providing wire has not been shorted.

After replacing the micro switch, carefully rewire correctly.

Note: If the positive wire from the battery is connected to the "B" terminal, the switch is bypassed and the pump cannot shut off, Pressure will build up until the motor stalls. If the proper fuse has been used, it will blow. If a larger fuse than recommended has been used, the motor will stall and may burn out.

Check Valve Problems

Due to contamination from debris or lime build-up, the check valve may fail to properly seat. To correct, clean out the area and replace the check valve element. If checking the check valve with air, be certain to moisten the check valve to get an accurate check. The rubber seals more effectively when wet.

Properly installed, the Pump will:

PRIME: The pump will automatically prime itself.

AIR-LOCK- Pump will not airlock, as the compression stroke is powerful enough to pressurize the entrapped air and force the check valve open.

RUN DRY: Pump will run dry for extended periods without damage.

BATTERY DRAIN: At free flow, the pump draws a mere 7 to 7 ½ amps.

CHECK VALVE: Built-in check valve prevents back flow and can protect the pump from the dangers of high city water pressure (up to 200 PSI).

FULLY AUTOMATIC: The pump will automatically come on when the faucet or valve is opened. It delivers a smooth, steady flow of water and shuts off automatically when the faucet is closed.

AIRSTREAM INTERNATIONAL TRAILER OWNERS MANUAL

Trouble Shooting

MOTOR DOES NOT OPERATE.

- Is battery discharged?
- Are any wires disconnected?
- Are terminals corroded?
- Is switch in "ON" position?
- Is fuse good?
- Is water frozen in pump head?

MOTOR RUNS BUT NO WATER FLOWS.

- Is water tank empty?
- Are there kinks in the inlet hose?
- Is air leaking into inlet hose fittings?
- Is inlet line or iii-line filter plugged?
- If using a filter, check the line just before the filter.
- Is outlet hose kinked?

MOTOR RUNS BUT WATER "SPUTTERS"

Check to be certain that air has been bled off the lines and water heater. Also check for air leaks in the input side of the pump.

PUMP CYCLES ON AND OFF WHEN ALL OUTLETS ARE CLOSED.

The pump will normally cycle (go on and off) when a faucet is partially opened. If, however, it cycles when all valves are closed, check for a leak in the lines. It may be a leaky toilet valve or a dripping faucet. Do not forget to check the outside city water entry valve. It may be leaking.

If no leak can be detected, shut pump off. Remove the output hose where it joins the system (not at the pump). Insert a plug in the hose and clamp it. (You can make a perfect plug from a barb fitting: ½ " size with a cap tightly screwed on the threads.) Turn the pump switch on. The pump should come on, run a few seconds, and then shut off. If it remains off, the problem is NOT the pump. The problem is in the system.

If, however, the pump goes on and off, there may be a problem in the pump. There may be an internal leak in the pump that allows water to escape from the high-pressure area back into the low-pressure area. Look for a pump valve held open or a crack in the plastic parts.

PUMP DOES NOT ACHIEVE SHUT OFF

The wall switch may be used for temporary control of the pump. A low battery charge may be the cause. Or the pump switch mechanism may be stuck. Try tapping the switch cap on the end of the pump with the handle of a screwdriver. If the pump appears in all other respects to run normally, but fails to shut off, you may have to replace the switch mechanism.

PUMP HEAD LEAKS

If the pump head leaks, first try to tighten the screws in the pump head assembly until they are snug.

CAUTION: Do not over tighten. The leak may be from a crack in the pump head assembly. If so, then replace.

One cause of the pump head cracking may be water freezing inside the pump head. If the leaking water is escaping back near the motor, check for a leaking or broken piston.

AIRSTREAM INTERNATIONAL TRAILER OWNERS MANUAL

Pump Repair

- Screws (A) hold the entire pump head assembly to the motor.
- Screws (B) hold the pump head face to the pump head main body. Screws (C) hold the switch assembly to the front of the pump head.
- Screws (A) would be removed to correct a problem in the "drive train" between the motor and pump head. Screws (A) and (B) would be removed to correct a problem in the pump head valves or pumping chambers.
- Screws (C) would be removed to correct a problem in the automatic switch or check valve.

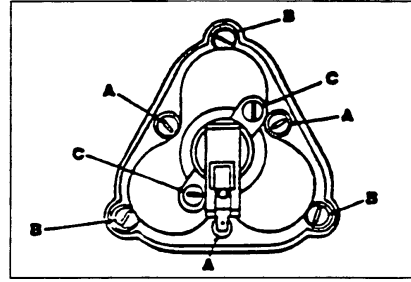

PUMP HEAD REPAIR

Motor and drive train.

Rarely does a problem occur in this area of the pump head. If a part does fail, it is quite easily replaced. Just be certain to follow closely the sequence of parts as shown in the figure. Also be careful to align the flat surface in the drive adapter with the flat surface on the motor shaft.

LUBRICATION

If the lubricant appears dried out it should be wiped off the bearing assemblies. A small amount of automotive wheel bearing grease should be applied to both sides of each bearing.

FAILURE TO PRIME

Failure to prime can be caused by the presence of some foreign matter lodged in the valve preventing it from seating. To correct, remove any such foreign bodies.

CAUTION: Do not remove the stainless steel screens. These filter screens should be cleaned without removing them from the plastic housing.

PUMP CHAMBER REPAIR

Replacement of broken piston:

To remove a piston, back out the screw holding the defective piston. Now lift the corner of the diaphragm and remove the broken piston. Insert the new piston through the diaphragm and slide the retaining ring on. Rotate the piston until it drops into place in the drive plate. Replace the screw and tighten until snug.

CAUTION: Do not attempt to re-use a piston once it has been removed. The plastic stem, if used a second time, may not hold securely. The second thread path removes additional material and there is then no real bite.

REPLACE A DIAPHRAGM

To replace a diaphragm follow the procedure used in removing the pistons. After removing the three pistons the diaphragm is loose and easily removed.

- Screws (A) hold the piston.
- Screws (B) hold the drive mechanism and should not be removed when replacing piston.

AIRSTREAM INTERNATIONAL TRAILER OWNERS MANUAL

SANITIZING

Potable water systems require periodic maintenance to deliver a consistent flow of fresh water. Depending on use and the environment the system is subject to, sanitizing is recommended prior to storing and before using the water system after a period of storage. Systems with new components, or ones that have been subjected to contamination, should also be disinfected as follows:

1. Use one of the following methods to determine the amount of common household bleach needed to sanitize the tank.
 - A) Multiply "gallons of tank capacity" by 0.13; the result is the ounces of bleach needed to sanitize the tank.
 - B) Multiply "Liters of tank capacity" by 1.0; the result is the milliliters of bleach needed to sanitize the tank.
2. Mix into solution the proper amount of bleach within a container of water.
3. Pour the solution (water/bleach) into the tank and fill the tank with potable water.
4. Open all faucets (Hot & Cold) allowing the water to run until the distinct odor of chlorine is detected.
5. The standard solution must have four (4) hours of contact time to disinfect completely. If you double the solution, this concentration allows for contact time of one (1) hour.
6. When the contact time is completed, drain the tank. Refill with potable water and purge the plumbing of all sanitizing solution.

Note: The sanitizing procedure outlined above is in conformance with the approved procedures of RVIA ANSI A119.2 and the U.S. Public Health Service.

Note: Two petcocks, located on the tank pans under the trailer just in front of the wheels on the roadside are the low point drains for the hot and cold water lines. A large valve located nearby will drain the fresh water tank sufficiently for most purposes. Total drainage may be achieved by removing the large Allen Head Plug located on the bottom of the tank. An access plate must be removed to expose the plug.

AIRSTREAM INTERNATIONAL TRAILER OWNERS MANUAL

CITY WATER HOOK-UP

The city water hook-up is found on the lower roadside of the trailer.

Use a high-pressure hose of at least 1/2" diameter. It should be one that is tasteless, odorless and non-toxic designed for RV use. The city water inlet is a standard garden hose thread. We suggest you carry two lengths of hose. This way you have the ability to reach hookups further away than normal, plus you have a spare hose should one fail or become damaged unexpectedly.

After hooking up the hose and turning on the city water valve provided in the park, slowly open a faucet. There will be a lot of spurts and sputtering until all the air is expelled from the trailer system. If the water heater and fresh water lines are empty it will take some time before all the air is expelled and you get a steady flow of water at the faucet. Once a steady flow is achieved at one faucet the others should be opened long enough to expel the air in the lines going to them.

CAUTION: Hydrogen gas can be produced in a hot water system served by this heater that has not been used for a long period of time (generally two weeks or more). Hydrogen gas is extremely flammable. To reduce the risk of injury under these conditions, it is recommended that the hot water faucet be opened for several minutes at the kitchen sink before using any electrical appliance connected to the hot water system. If hydrogen is present there will probably be an unusual sound such as air escaping through the pipe as the water begins to flow. There should be no smoking or open flame near the faucet at the time it is open.

Your plumbing system has a built in pressure regulator to protect your lines and faucets from extremely high pressures on some city water systems.

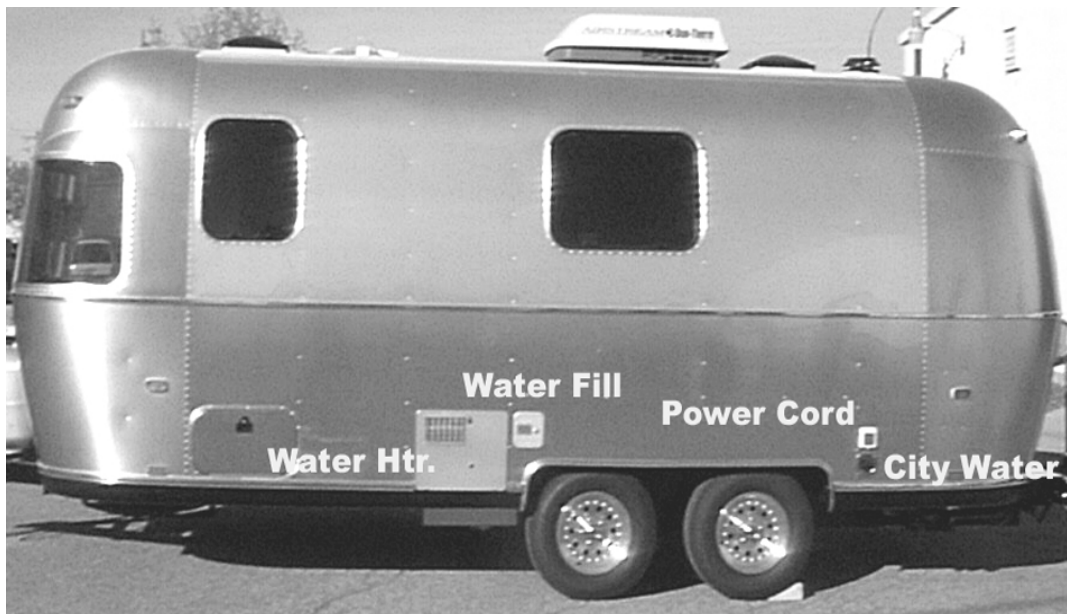

AIRSTREAM INTERNATIONAL TRAILER OWNERS MANUAL

GALLEY FAUCET

MODEL 7570SL

Manufacturer:

United States
Moen Incorporated
25300 Al Moen Drive
North Olmstead, OH. 44070-8022
www.moen.com

Canada
Moen Inc.
2816 Bristol Circle
Oakville, Ontario L6H5s7

For US customer service, warranty, and a local parts outlets contact Moen at 1-800-BUY-MOEN (289-6636).

For Canadian service contact: Toronto 905-829-3400, Rest of Canada 1-800-465-6130

Care Instructions

As with any fine polished surface, your faucet will retain its shine for years to come with proper care. The LifeShine™ finish on the faucet does not require the extraordinary work needed to maintain most fine polished brass finishes.

Be sure to read and follow usage instructions enclosed any scour pad or scrub sponge before use.

- **Caution:** Do not use pads or sponges that specifically do not recommend use for cleaning polished services.
- **Caution:** Many pads or sponges with green fibrous surface (such as Scotch-Brite™ heavy duty scrub sponges) contain microscopic mineral particles that can scratch nearly all polished services, including this faucet finish.

The LifeShine™ finish can be cleaned with most household cleaners (including mild abrasives), when used according to their manufacturers instructions for use.

- Rinse any strong cleaners off immediately after used to maintain the LifeShine™ finish luster.

Mild scrubbing with fine steel wool (0000 grade) can remove build up dirt or water stains.

Visible water spots on this highly lustrous and reflective finish can be easily wiped off with a cloth dampened with water or with glass cleaner.

AIRSTREAM INTERNATIONAL TRAILER OWNERS MANUAL

GALLEY FAUCET

SERVICE

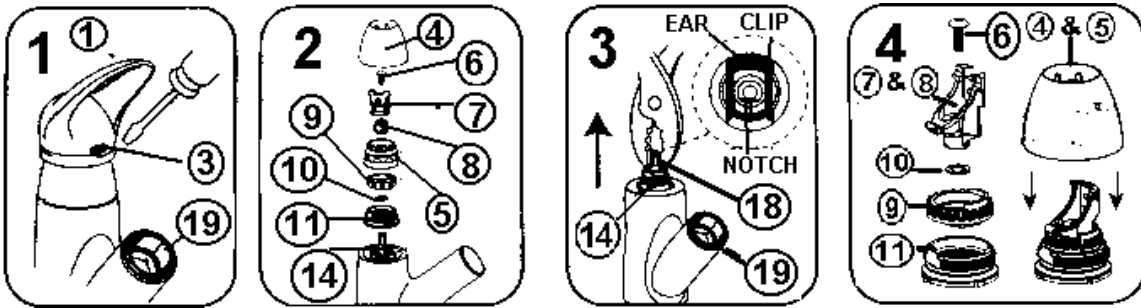

CAUTION: Always turn water OFF before removing existing faucet or disassembling the valve. Open faucet handle to relieve water pressure and ensure that complete water shutoff has been accomplished.

1. Remove plug bottom (3) from the handle by prying the button upwards from the bottom center. Be careful not to scratch the handle. Leave the handle up. Use a 7/64" hex wrench, remove screw (2). Remove handle (1).
2. Unscrew dome pivot retainer (4 and 5), cartridge screw (6), handle adapter and connector assembly (7 and 8), pivot stop (9). Remove DD washer (10) and retainer nut (11). Using a flathead screwdriver, remove the retainer clip (14).
3. Grasp cartridge stem with pliers, pull cartridge (18) straight up.

Reinstall has follows: Install cartridge (18) into valve body with notched flat on stem facing forward. Be sure to position the ears of the cartridge in the front and back. Reinstall the retainer clip (14) that straddles the ears on the cartridge.

4. Reinstall the retainer nut (11) and pivot stop (9) with the stop in front as shown in Step 4 above. Reinstall DD washer (10) and reassemble handle connector and handle adapter (8 and 7). Notes: Orientation of this subassembly has shown in Step 4. Install cartridge screw (6). Be sure to install completely to prevent unwanted closure of faucet. Thread on dome and pivot retainer (4 and 5) clockwise until hand tight. Reinstall handle (1), set screw (2), and plug button (3).

Note: To service vacuum breaker assembly, (anti-siphon protection) the hose (17) must be disconnected from the threaded discharge (20) prior to removing the spout receptor (19).

AIRSTREAM INTERNATIONAL TRAILER OWNERS MANUAL

GALLEY FAUCET

Parts List

MODEL 7570SL

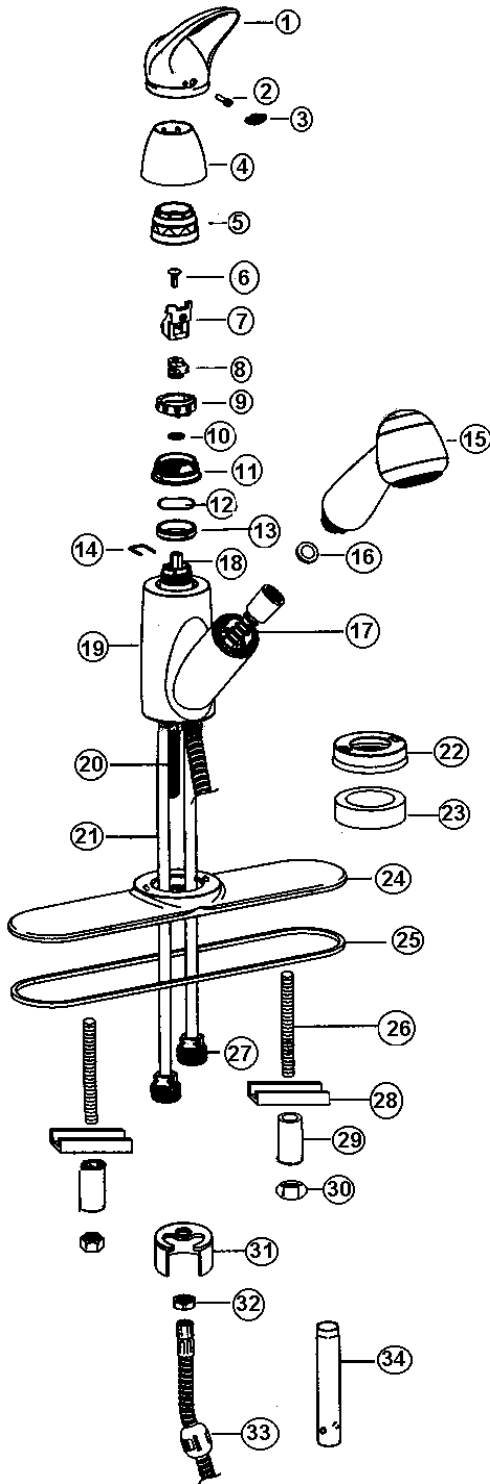

1. Loop Handle
2. Screw
3. Plug Button
4. Dome
5. Pivot Retainer
6. Cartridge Screw
7. Handle Adapter
8. Handle Connector
9. Pivot Stop
10. Double D Washer
11. Retainer Nut
12. Wave Spring Washer
13. Bearing Washer
14. Retainer Clip
15. Pull-out Spout
16. Screen Washer
17. Hose
18. Cartridge
19. Spout Receptor
20. Threaded Discharge Tube
21. Supply Tubes (2)
22. Deck Ring
23. Deck Ring Gasket
24. Deck Plate
25. Gasket
26. Deck Plate Studs (2)
27. 1/2" Threaded Fitting (2)
28. Clamp Bar (2)
29. Spacer (2)
30. Small Mounting Nut (2)
31. Mounting Bracket
32. Mounting Nut
33. Counter Weight
34. Mounting Tool

AIRSTREAM INTERNATIONAL TRAILER OWNERS MANUAL

NOTES

AIRSTREAM INTERNATIONAL TRAILER OWNERS MANUAL

DRAIN VALVES

The hot and cold water line low point drain valves are located on exterior of the coach for easier access. If you look under the trailer in front of your tires on the roadside you can see a galvanized "box" that is a few inches lower than the trailer frame. This "box" or pan supports the water tank. The line drain valves will be the two brass petcocks extending from the end of the pan. Open these low point drain valves to drain the water out of the hot and cold water lines.

To Empty Fresh Water Tank

The large valve next to the low point drain petcocks under the trailer drains the water fresh tank.

Pumping the water out with the self-contained water pump also empties the fresh water tank. Simply turn on the pump switch and open a couple of faucets until the water will no longer comes out.

An additional 1 ¼" drain plug is located on the bottom of the tank inside the galvanized "box". The plug is accessible by removing an inspection plate close to the petcock that can be seen on the bottom of the tank support pan. There may be a little Styrofoam insulation covering the plug that should be carefully removed.

Note: For winterizing purposes, only the large tank drain valve needs to be opened to drain the fresh water tank.

Water Heater Draining

All models have a drain plug or petcock on the water heater. Access is from the exterior. The plug or valve is usually located in the lower left corner, viewed as you face the exterior of the water heater.

SHUT OFF VALVES

Your Airstream has one other water valve besides the water heater by-pass system. It is located behind the toilet and used to shut water off to the toilet in an emergency or service situation. The water heater by-pass valves are discussed in the next section on winterizing.

AIRSTREAM INTERNATIONAL TRAILER OWNERS MANUAL

WINTERIZING AND STORAGE

When storing your trailer for short or long periods use the same precautions as you would in your own home in regard to perishables, ventilation and rain protection. In addition, for prolonged storage periods flush out all the drain lines and the holding tanks. Also drain the entire water system including the water heater and the water storage tank. Instructions for draining the water system are explained in the following paragraphs on winterizing.

THE MAIN CONSIDERATION IN WINTERIZING IS TO GUARD AGAINST FREEZING DAMAGE TO THE HOT AND COLD WATER SYSTEMS, THE WASTE DRAIN SYSTEM (INCLUDING THE TRAPS), AND THE WATER HOLDING TANKS, THE WATER HEATER, AND THE BATTERY.

To completely winterize your trailer follow this procedure.

1. Level the trailer from side to side and front to rear. Open all faucets
2. Turn the water pump switch to the ON position to expel water from the storage tank or open the fresh water tank drain valve.
3. Open all low point water drain valves including drain plug or valve on water heater (See drain valves on previous page).
4. While the water is draining from the system, open and flush the toilet-flushing valve. Depress hand spray lever while holding the spray head down inside the bowl. Depress hand spray thumb button on the telephone showerhead while holding down inside the tub and drain all water from the flexible hose. Unscrew the heads on both spray units and store.
5. Turn the pump switch OFF after all water has been removed from the storage tank.
6. Remove outlet hose from water pump.
7. Disconnect the water pump inlet connection and turn the pump on until all the water is expelled. This water, about ½ cup, can be caught in a towel or rag.
8. Lower the front of the trailer as far as the jack will allow until water ceases to drain, then raise the jack up as high as it will go and let any remaining water drain out.
9. After the water has stopped running from the drain lines, apply at least 60 lbs, of air pressure at the city water inlet. An air to city water adapter is available from your dealer's RV accessory store. Be sure the toilet valve and all drain valves and faucets are open and pump outlet hose is disconnected. This can be accomplished at a service station and will force any remaining water from the water heater and remove any water which may be trapped in low areas.
10. Pour a cup of *approved non-toxic RV antifreeze into the lavatory, sink and tub drains to prevent trap freeze-up.

*Approved and listed by a recognized testing authority such as UL (Underwriter Lab).

11. Be sure to open the waste holding tank drain valves and drain and flush the tanks thoroughly (THIS IS VERY IMPORTANT AS THE SEWAGE IN THE TANKS, IF FROZEN, COULD SERIOUSLY DAMAGE THE TANKS.)

AIRSTREAM INTERNATIONAL TRAILER OWNERS MANUAL

12. Remove the cartridge of the water purifier and leave the purifier valve in the open position. (If so equipped.)
13. Remove the battery from your trailer and store in a cool dry place where there is no danger of freezing. It is very important for optimum life of a battery to check it periodically and to keep it fully charged.
14. Remove any items (food, cosmetics, etc.) from trailer interior that might be damaged by freezing - or might damage the trailer if containers break.

For additional winterizing protection add a non-toxic antifreeze (approved for drinking water system) to the water lines using the following procedure.

1. Reconnect all lines except the hose to the pump inlet port. Close all drain valves.
2. Turn water heater by-pass valves to the by-pass position: open valve B – close valves A and C (**See illustration below**). They are located under the roadside wardrobe hinged bottom shelf on the CCD unit and under roadside front dinette seat (remove the seat cushion and lift the seat bottom up) on the AS model. In some models the valves may be in a horizontal pattern or on top of the heater, rather than the vertical shown in the illustration. Valve operating sequence will be the same.
3. Attach a length of hose to the pump inlet port. This piece of hose should be long enough for the free end to be inserted into and reach the bottom of the antifreeze container.
4. Dilute the antifreeze solution in accordance with the manufacturer's instructions.
5. Open all water faucets.
6. Insert hose length into the antifreeze container, turn the pump switch on, and run the water pump until the antifreeze solution fills all water lines. Flush toilet. Work hand shower spray while holding down in tub.
7. Shut off the pump and close all faucets.
8. Disconnect the hose length from pump inlet fitting and reconnect water system inlet line.

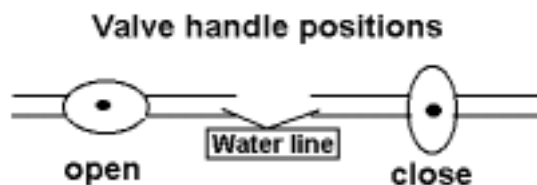
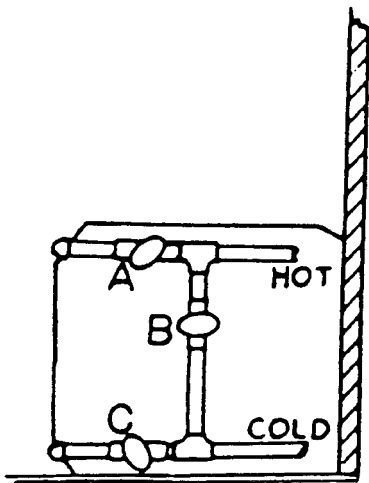

Valves may be on top of water heater.

AIRSTREAM INTERNATIONAL TRAILER OWNERS MANUAL

22 Ft International AS Fresh Water Layout

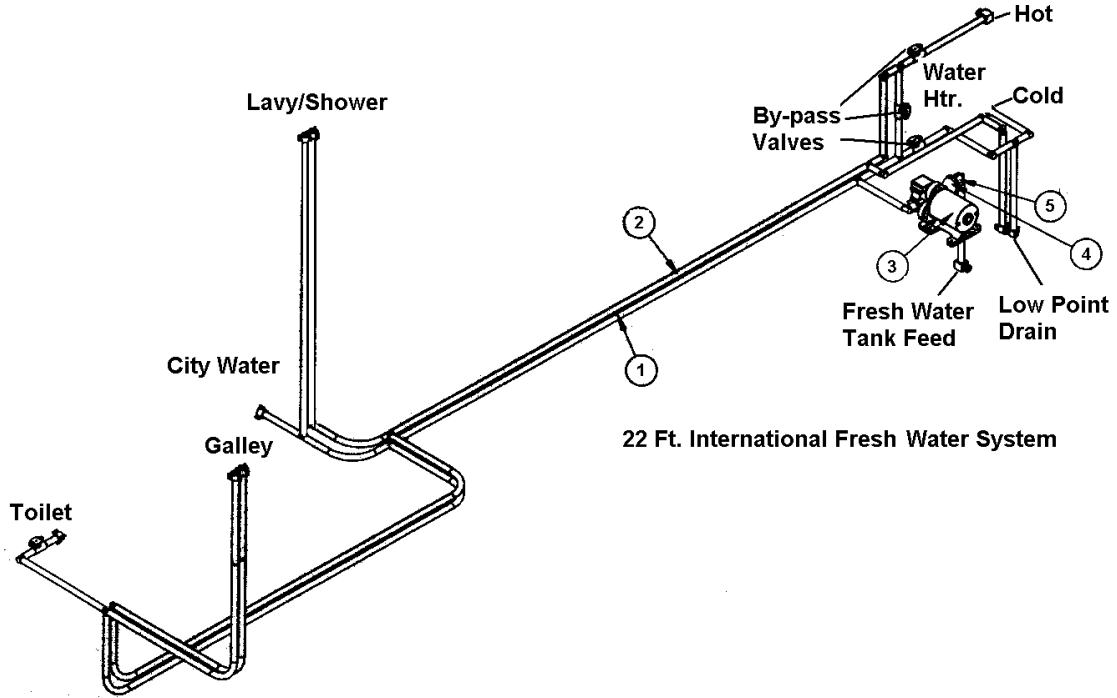

22 Ft International CCD Fresh Water Layout

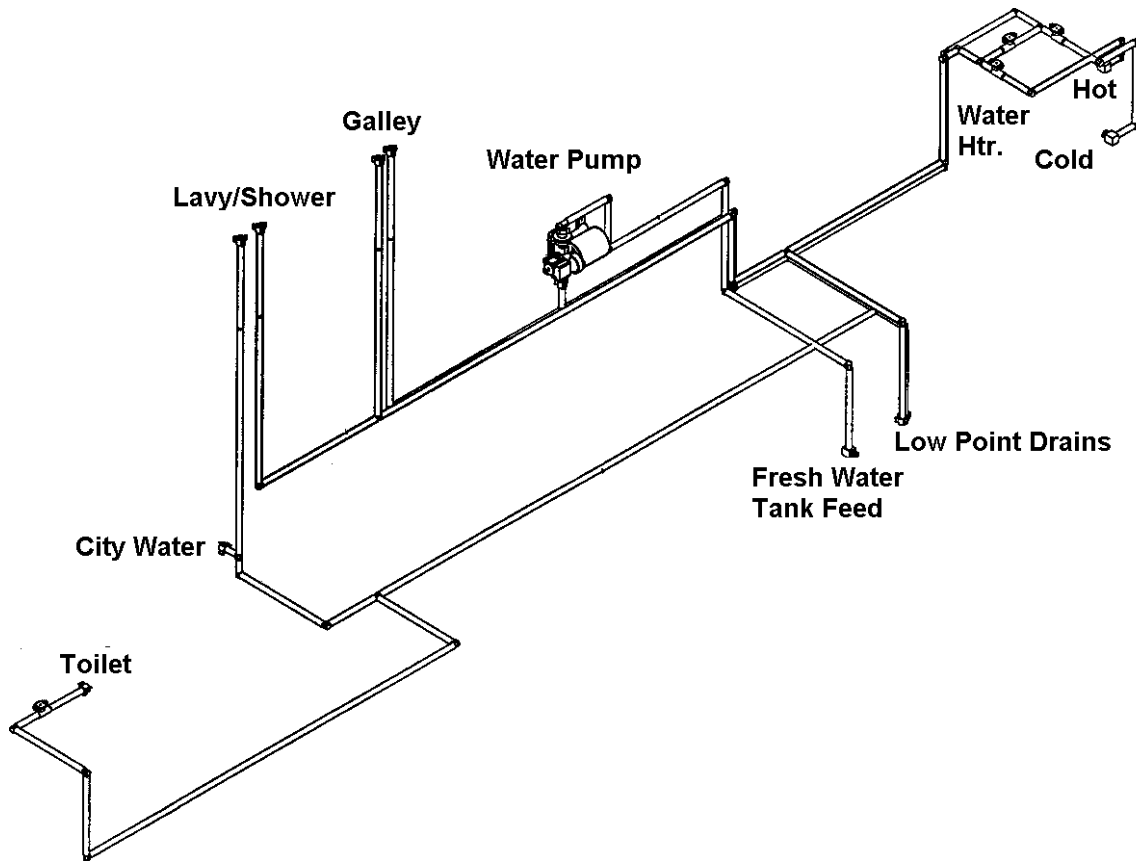

AIRSTREAM INTERNATIONAL TRAILER OWNERS MANUAL

DRAIN AND WASTE SYSTEM

Your trailer has a drain and waste system that includes waste-holding tanks made from molded plastic, free from corrosion problems, with trouble-free dump valves.

The MAIN (BLACK) HOLDING TANK enables you to use the toilet for several days away from disposal facilities. The wastewater from the sink, shower, bath and lavatory drains in the AUXILIARY (GRAY) HOLDING TANK. Each tank has its own dump valve, however, both tanks drain through a common outlet. Therefore, you need to make only one connection when hooking up in a trailer park with sewer facilities.

CAUTION: Never put wet strength paper towels or tissues in your holding tank since they won't dissolve and can "catch" in the mechanism of the dump valve. Colored toilet tissue is slower to dissolve than white. Most RV accessory stores offer tissue designed for RVs that will completely dissolve.

Deodorizers

There are many deodorizers on the market in tablet, liquid and powder form. These not only combat odor, but also stimulate the bacteria that works to dissolve the solids in your tank.

Monitor Panel

Check your monitor panel frequently. When the MAIN HOLDING TANK, (BLACK) is completely full, sewage cannot be emptied from the toilet bowl. If the AUXILIARY HOLDING TANK (GREY) is overfilled, drain water will "backup" into the tub and cause an unpleasant cleaning job. Never drain the tanks at any place other than an approved dumping station. For complete instructions on this panel see section G.

Emptying Tanks

Almost all campgrounds will have dumping facilities. Park directories such as Woodalls and Rand McNally also list dumping stations.

To empty one or both tanks attach the sewer hose by pressing the bayonet fitting onto the dump valve outlet and rotate clockwise until it feels solid and secure. Attach the outlet end of the hose to the sewage outlet; making sure that the hose is placed so it will drain completely.

Pull the dump valve handle as far as it will go and wait until the tank is drained. When dumping, the main holding tank should be dumped first; then the auxiliary holding tank. This will help to rinse out the sewer line with auxiliary holding tank water.

The main holding tank must be flushed out until all paper and waste material is removed. Close the dump valve and refill the tank with clean water and repeat until clean. Replace the cap prior to traveling.

AIRSTREAM INTERNATIONAL TRAILER OWNERS MANUAL

When Parked and Connected to Sewer Outlet

When you are in a park and connected to a sewer outlet keep the main holding tank dump valve closed, and empty the tank every few days or whenever it becomes almost full. **ONLY BY SENDING A LARGE VOLUME OF LIQUID THROUGH THE MAIN HOLDING TANK AT A TIME WILL TOILET PAPER AND OTHER SOLIDS COMPLETELY WASH AWAY.**

This practice will avoid the accumulation of solids in the main holding tank, which could lead to an unpleasant cleaning job. Should solids accumulate, close the dump valve; fill the tank about half full with water, then tow the trailer for a few miles. The turbulence and surging of the water will usually dissolve the solids into suspension so the tank can be drained. Keep the auxiliary tank valve open when connected to a sewer outlet.

Draining the tanks as described will protect them from freezing during storage. When traveling in sub-freezing temperatures use a winterizing solution designed for RV use. Follow the directions on the container.

Drain Systems Cleaning

The only cleaning agents that can be used without causing harm to the system are household ammonia and tri-sodium phosphate in small quantities. Do not use any product that contains any portion of petroleum distillates. This attacks the rubber seats of your toilet and dump valve. Also, do not use any dish detergent or abrasive cleaners. All products should be marked approved for ABS drainage systems.

When winterizing drains use only trailer plumbing system type antifreeze. These are sold through your dealer.

AIRSTREAM INTERNATIONAL TRAILER OWNERS MANUAL

Drain Diagrams

22 Ft. International AS & CCD Trailer

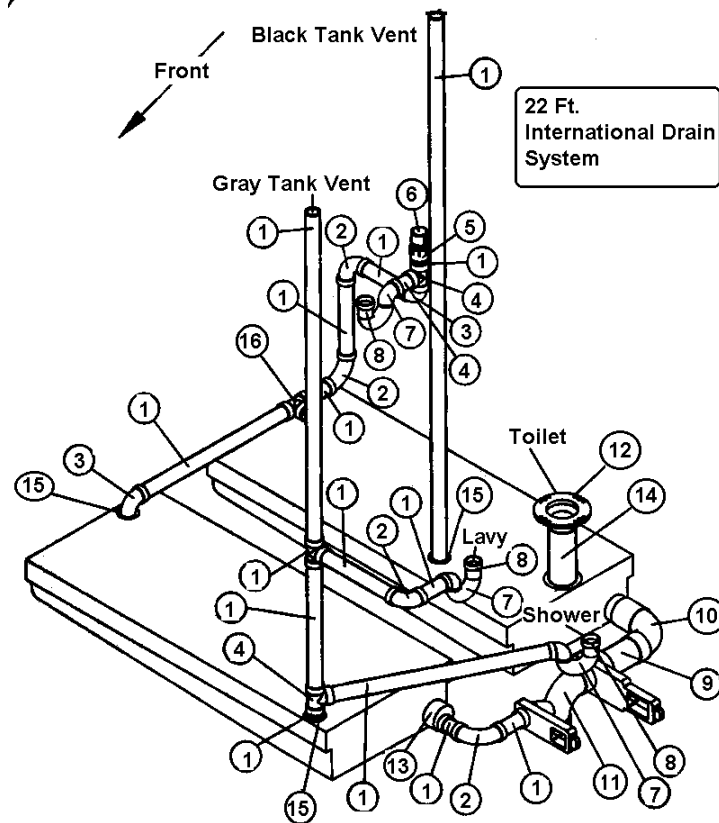

943577 Above/Below Floor Drain Diagram & Part Numbers

- | | | |
|-----|------------|---------------------------------------|
| 1. | 601160-02 | Pipe, ABS DVW, 1 1/2" |
| 2. | 600035 | Ell, ABS long sweep, 1 1/2" |
| 3. | 600431 | Elbow, 90 degree, 1 1/2" |
| 4. | 600156 | Tee Sanitary |
| 5. | 600308 | Adapter, ABS female Sloan |
| 6. | 600538 | Vent, V-200 automatic |
| 7. | 600144 | P-trap, ABS 1 1/2" |
| 8. | 600822 | Adapter P-trap |
| 9. | 600160-04 | Pipe, ABS DVW, 3" |
| 10. | 600820 | 3" single socket, 90 degree |
| 11. | 601482 | Dump valve, rotating assembly |
| 12. | 601266 | Flange, closet, 3 x 4, slip fit |
| 13. | 195329-229 | Reducer adapter, 3" to 1 1/2" |
| 14. | 601267-04 | Nipple, 3" diameter, threaded one end |
| 15. | 340084-20 | Clamp, hose, .81"-1.75" |
| 16. | 601318 | Tee, bi-directional cleanout, 1 1/2" |

AIRSTREAM INTERNATIONAL TRAILER OWNERS MANUAL

TOILET

Manufacturer: Sealand Technology
13128 State Route 226
P.O. Box 38
Big Prairie, Ohio. 44611
Phone: 1-800-321-9866

The RV toilet in your Airstream is a design that has been used for many years.

In normal use simply depress the pedal and this dumps the sewage while fresh water flushes down the side of the bowl. Water will continue to run into the bowl for a short time after the pedal is released.

CAUTION: When you dump the bowl of the toilet make sure all paper and solids have cleared the mechanism before you allow it to close. Failure to do so can cause the mechanism to become jammed and it will no longer close completely.

The Owner's Manual supplied with the toilet has several maintenance and cleaning instructions. Please read and follow all instructions.

AIRSTREAM INTERNATIONAL TRAILER OWNERS MANUAL

ELECTRICAL

OPERATION

The major portion of electrical power in your Airstream is 12-volt. The 12-volt current powers the fans, furnaces, water pump, and water heater ignition. The exception would be the air conditioner and microwave oven.

All 12-volt current comes through the battery system in the front of your trailer. The battery is accessible in the battery box on the A-frame of your trailer. Power from the battery goes to a set of four Type 2 thermal breakers located under the front bed and riveted to the inside skin front plate. The breakers are tied together by a brass bus bar. One breaker (30 Amp.) protects the 12-volt tow vehicle charge line coming from the 7-way cord. Another breaker (20 Amp.) feeds the trailer brakes breakaway switch located near the hitch coupler. A 50 amp. breaker feeds the Battery Disconnect relay. The current leaves the relay and goes to the 12-volt distribution panel located in the converter and then to the rest of the trailer. Open the brown decorative door on the front of the converter under the dinette to access the panel and its fuses. A 12-volt layout diagram is shown later in this section.

BATTERY DISCONNECT SWITCH

The disconnect switch is used to separate the battery from the 12-volt distribution panel and converter charging system.

When the switch is turned **“use”** (on) and the trailer is plugged into a 110-volt shoreline, the 12-volt distribution panel will receive power from the converter and the battery will be charged through the converter charging system.

When the switch is turned to **“store”** (off) and the trailer is plugged into a 110-volt shoreline, the 12-volt distribution panel will still receive power from the converter, but the battery is disconnected from the system. The battery will not be drained with the switch in the store position. The converter will not charge the battery with the switch in this position.

The charge in the 12-volt batteries is replenished when towing from the tow vehicle alternator through the 7-way cord. This charge will go to the battery no matter which position the Battery Disconnect Switch is in.

AIRSTREAM INTERNATIONAL TRAILER OWNERS MANUAL

BATTERY



WARNING: Before inspecting or servicing storage battery, read and follow battery manufacturers cautions and directions.

CAUTION: A normal battery can discharge by itself in 30 to 40 days when not in use, therefore, IT IS NECESSARY TO PERIODICALLY CHECK THE BATTERY AND CHARGE IT AS IS NECESSARY.

We suggest checking the battery at least every two weeks in freezing weather. The temperature at which a battery will freeze depends on the condition of its charge. As an example: a fully charged battery with a specific gravity of 1.265 will not freeze until the electrolyte temperature drops to - 71.3 degrees F, while a discharged battery will freeze at +19 degrees F. The following table shows the freezing points of batteries at various specific gravity readings, temperature corrected 80 degrees F.

1.265	-71.3 F
1.250	-62 F
1.200	-16 F
1.100	+5 F
1.150	+19 F

Do not add water to a battery in freezing temperatures unless the vehicle will be put to use at once, otherwise the added water may freeze. Neglect is expensive. Care costs little. Check your batteries regularly.

MAINTAIN A CLEAN BATTERY TOP AND CHECK TERMINALS AND CABLES FOR TIGHTNESS AND CLEANLINESS. A dirty battery will dissipate its charge through surface contamination. Clean battery top with a damp cloth and dry thoroughly.

The terminals should be tight and free of corrosion. To clean terminals, neutralize with a solution of baking soda, rinse in clear water, and dry.

Note: Care must be used to make sure soda is not allowed to enter battery cells.

To insure maximum battery capacity on the charge and the discharge, the battery terminals and the inside portion of the cable connector should be scraped or brushed until both of these surfaces are shiny bright. The cable connectors should then be reconnected to the battery and tightened. The complete assembly, battery post and cable connector should be coated with heavy body mineral grease, petroleum grease or petroleum jell.

CAUTION: RECONNECT THE BATTERY CABLES TO THE CORRECT BATTERY POSTS. The black cable should be connected to the negative (-) post and the red cable to the (+) post. The polarity of your tow vehicle must also be negative (-) ground since it must always match the trailer. Most tow vehicles are negative grounded, but always check your vehicle owner's manual to be sure.

ADD WATER TO CELLS AS NECESSARY. Check the electrolyte level at least once a month. When you are traveling steadily and for an extended period of time, or if you are in climates above 90 degrees F, check the electrolyte level about every two weeks.

CAUTION: Do not fill battery above the split ring in filler opening. DO NOT MEASURE SPECIFIC GRAVITY IMMEDIATELY after adding water. The water must mix with the electrolyte by charging or by driving a few miles.

AIRSTREAM INTERNATIONAL TRAILER OWNERS MANUAL

Some situations, which may indicate a need for battery replacement, are:

1. Loss of more water in one cell than others.
2. Continuous loss of water in all cells-perhaps accompanied by overheating or extreme gassing and bubbling.
3. A marked difference in the specific gravity reading between cells.



WARNING: The gases generated within a storage battery cell may be ignited by an open flame or spark in the vicinity of the battery. Do not use a match or flame to provide light for checking the level of the water.

During the winter the battery should be removed from the trailer and stored in a cool, dry place, where there is no danger of freezing. It should be kept full of water, cleaned and charged monthly. A battery that is allowed to completely lose its charge will never regain its original power or a full charge.

Remove the battery from its container.

For battery service or replacement, go to any service station or dealer who sells and services the make battery installed in your trailer.

When being towed, the 12-volt battery in your trailer is receiving a constant charge from the car's generator or alternator through the seven-way connector.

Your automobile's voltage regulator controls the charge rate. It is important to keep the seven-way connector clean. One method is to use "Spra-Kleen".

Whenever possible use the automatic built in charge of the converter system for charging. The charging circuit automatically controls the current, reducing it as the battery increases in charge.

At service stations make certain they give your battery a slow charge because quick charges will drastically shorten the life of the battery, as will allowing repeated complete discharges.

POWER CENTER (Converter, 12-Volt Distribution, 110Volt Distribution) MagneTec 7300

Manufacturer:

MagneTec
102 North Main Street
Goodland, Indiana 47948
Phone: (800) 443 4859
Fax: (219) 297 2305

The converter/charging system is the interior low voltage electrical system that enables you to use the interior lights, fans, pumps and 12-volt appliances whether operating on self-contained battery power or 120-volt city power. The 12-volt light bulbs give off the same light as regular household bulbs, so that when operating on self-contained battery power, everything works normally except the 110-volt convenience outlets and 110-volt appliances. The converter system is designed to maintain constant output voltages regardless of the variances that occur in city power systems.

AIRSTREAM INTERNATIONAL TRAILER OWNERS MANUAL

12V POWER CIRCUITS

The current in the converter system is 12 volts direct current (12VDC) negative grounded.

Power sources that supply 12VDC current to the system are as follows:

- A. Main charge line from tow vehicle
- B. Trailer Battery
- C. Converter

The power sources above are all electrically connected to the 12-volt distribution fuse panel that distributes current to interior branch circuits. The circuits provide power to operate all 12-volt DC lights, pumps, motors and appliances.

The 7300 series power converter is a solid-state electronic power supply and is maintenance free. It is so self-sufficient and quiet that you will probably not know it is working except for the fact that your batteries are always charged, and your 12-volt lights and appliances always work. If any 12-volt appliance fails to operate, first check your recreational vehicles 12-volt distribution fuse block located behind the decorative front door in the front right hand corner of the converter and inspect all fuses. If a fuse is opened or blown replace it with the same size fuse (never install a larger use). If the fuse opens again, have an electrician or certified RV technician locate the circuit trouble. Replace blown fuses with Littelfuse type 257 fuses only.

If the 7300 series power converter is not working, first confirm the RV supply or shoreline cord is plugged into a live circuit. Then check all the 120-volt breakers in your RV distribution panel to make sure they are on. If the breaker is tripped, follow the instructions to reset the breakers. If the breaker trips again, consult an electrician or certified RV technician.

CONVERTER OPERATION

The MagneTec 7300 series electronic power converter is designed to supply the nominal 12-volt filtered D.C. power for all 12 volt operated devices encountered in RV service. Although the converter is an excellent battery charger, the converter does not require a battery to be connected to it for proper operation.

CAUTION: When installing a battery (s) always observe polarity. Connecting a battery reverse polarity will blow the power converter main fuses located on the 12 volt D.C. distribution fuse block.

120 VOLT AC PANEL BOARD

The AC panel board section of the series 7300 is located behind the decorative door in the upper left-hand corner. This panel contains the 120 Vac branch circuit breakers for your RV. One of the breakers controls the 120 volt power to the 12 volt converter section located in the lower half of the 7300. This breaker may also control another branch circuit. Check the label next to each breaker for what each branch circuit breaker controls.

The 120 volt circuits may be turned “on” by putting their breaker handle up to the on position or “off” by flipping the handle down to the off position. To reset the tripped breaker move handle to off then on.

AIRSTREAM INTERNATIONAL TRAILER OWNERS MANUAL

CONVERTER COOLING SYSTEM

The 7300 electronic fan cooling system is the key to long life and trouble-free operation. The fan is never on more than required to cool electronic components in the converter. You may never hear the fan operate.

Converter

The converter transforms 120-volt alternating current (AC) into 12-volt direct current (DC). This provides power to charge the trailer battery and to operate the 12 volt interior lighting, fans, and appliances.

The converter is energized only when the trailer is hooked up to 120-volt city power.

Converter Testing

- A. Confirm 120 volt power is going into converter.
- B. Disconnect the 12+ wire from the master switch.
- C. Using a voltmeter check voltage output between heavy positive and negative wires coming out of converter.
- D. The voltage must be within 13.8 and 14.0 volts. (The meter of the tester should be calibrated periodically.)
- E. If converter is not within these voltages, have it serviced by a qualified technician or replace it.

Converter Removal

- 1. Disconnect power cord for 120-volt supply.
- 2. Switch circuit breakers to off position.
- 3. Open brown decorative Power Center door.
- 4. Remove 4 screws holding the assembly in place and pull Power Center out. Be careful not to pull too far and damage wiring.
- 5. Mark all wiring positions.
- 6. Remove 110-volt power feed and other wiring.
- 7. To reinstall, reverse the removal procedures.

AIRSTREAM INTERNATIONAL TRAILER OWNERS MANUAL

TROUBLE SHOOTING

The most common failure in the exterior electrical system is an open circuit. An open circuit is an interruption in the current flow, which may be in either the wire to the component or in the ground return. Check the following areas for open circuits:

1. Light bulb (filament open.)
2. Loose or corroded connections at lighting device.
3. Loose or corroded connections at 7 way connectors.
4. Improper grounding at the lighting device.

A continuity light or an ohmmeter will help you isolate the point of the "open" on the circuit. Another cause of failure is a short circuit usually resulting in a blown fuse or cycling circuit breaker at the power source. The wire coming in contact with a sharp edge usually causes a short. The sharp edge wears the wire's insulation away until the "hot" wire short to ground.

Locating Shorts and Opens

The key in locating shorts and opens is isolation. The first step is to isolate the circuit with the short or open and then isolate the section of the circuit with the fault. Once the section is identified, the specific problem can be located. The cause may be a loose or corroded connection, cut wire, worn insulation, defective component, etc. The following paragraphs describe methods of isolating shorts and opens. There are several other approaches that may be used; however, these may be used as a guide.

Shorts

1. Locate circuit that has short by noting fuse blown or cycling breaker.
2. Remove fuses or wire from breaker, and open all switches. Check for continuity between (+) 12-volt wire or shorted circuit and ground. (If it cannot be determined if the switch is in the open position, remove the lead from the switch.) Continuity to ground indicates there is a short.
3. Remove leads of shorted circuits from converter and components one at a time. After disconnecting each component, check continuity of the (+) 12-volt wire to ground. If there is no continuity the short is in the component removed. If continuity still exists, continue with the following steps.
4. Inspect leads carefully where they pass through the skin or near sharp edges.
5. Note objects attached to skin after manufacturing. The mounting screws or rivets may be causing the short.
6. Remove multi-dome to expose main body of harness. Inspect harness for cause of short, such as rivets or screws in harness or evidence of drilling.
7. If short cannot be found, cut circuit into sections, checking each section for continuity. Shorts can be isolated by this method.
8. Examples of shorts are:
 - The (+) 12-volt wire contacting (-) negative wire or grounded surface.
 - Internal short in a 12-volt component or appliance.

AIRSTREAM INTERNATIONAL TRAILER OWNERS MANUAL

Opens

1. Check all components on circuit that has open. If all components are without power, begin to look for open on distribution panel.
2. Check for voltage on each side of the breaker. Check for tightness of crimp on connector and nut.
3. After inspecting all accessible wire on a circuit for opens, further inspection requires removal of interior skin to find the short or the installation of replacement wire. A qualified service center should be contacted for this repair.
4. Examples of open are:
 - Wire is cut.
 - Connector falls off component's terminal.
 - Loose or corroded connection.
 - Contacts in switch do not touch

COMMON ELECTRICAL PROBLEMS

PROBLEM: No 12-volt power, (Lights and appliances do not work.)

CAUSE & REMEDY:

1. Input line and/or battery not connected. Make necessary connections.
2. Master (Kill) switch not turned on,
3. Discharged trailer battery. Charge battery.
4. Trailer battery on wrong polarity. Make proper connections to battery terminals.

PROBLEM: Tripping Breaker

CAUSE & REMEDY:

1. Overloaded circuit. Turn off switches to reduce load.
2. Electrical short. Find tripping breaker distribution panel and identify circuit. Check the circuit for defective wiring, lamps or motors.
3. Shorted battery. Replace battery.
4. Battery terminals not properly connected to converter. Make proper connections.

PROBLEM: Dim lights or sluggish fan motor.

CAUSE & REMEDY:

1. 25-cycle or 50-cycle power (some foreign countries). Use 60-cycle power.
2. Discharged battery (when operating without 110 volt line) Charge battery.
3. Battery is low on water. Add distilled water to battery.

PROBLEM: Converter will not charge battery.

CAUSE & REMEDY:

1. Input line not connected. Connect.
2. Battery not connected or polarity reversed. Connect battery to converter (Check polarity).
3. Bad Battery. Replace.
4. Too many lights and appliances. Reduce electrical load

AIRSTREAM INTERNATIONAL TRAILER OWNERS MANUAL

12-VOLT WIRING DIAGRAMS

The main harness leaves the 12-volt distribution panel and runs around the roadside wall INSIDE the trailer. In the area of the credenza table and going cross car between the water tanks the harness is under the floor in protective covers.

About halfway back the trailer, the main body interior harness goes up the wall and plugs into the ceiling harness. The ceiling harness runs at the corner junction of the sidewall and ceiling on the curbside with branches running straight out to the lights and fans. All models are pre-wired for solar panel. The following diagrams list the circuits and show the location of the harness and give the wire color and gauge for each function.

DIAGRAMS:

12-volt exterior and 7-way plug, all

22 Ft. International AS & CCD 12-volt Layout

22 Ft International AS & CCD 12-volt Distribution Panel

22 Ft. International AS 12-volt Circuit chart

22 Ft. International CCD 12-volt Circuit chart

22 ft. International- Tail light Harness

22 ft. International – Front Clearance Light Harness

22 ft. International – Interior Body Harness

22 ft. International – Ceiling Harness

AIRSTREAM INTERNATIONAL TRAILER OWNERS MANUAL

12-VOLT EXTERIOR

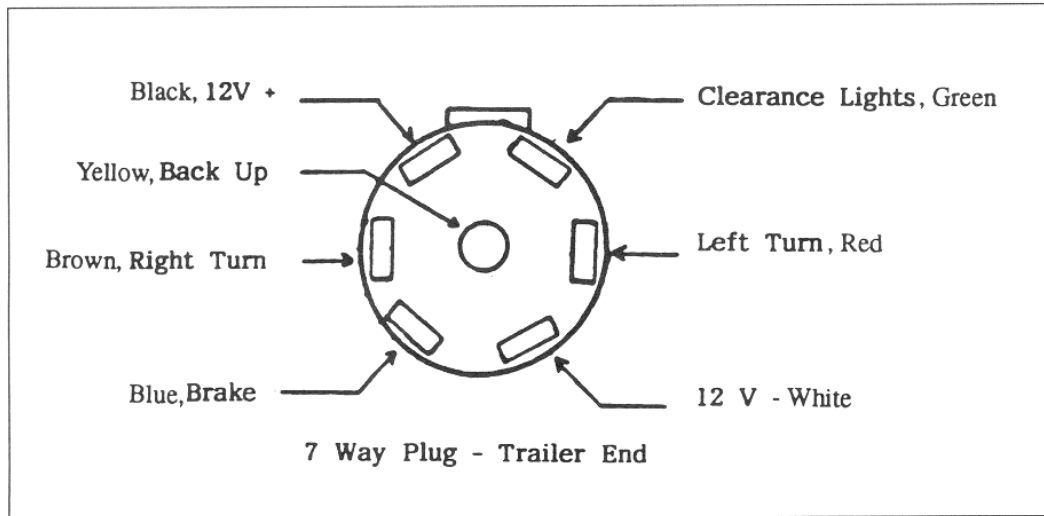
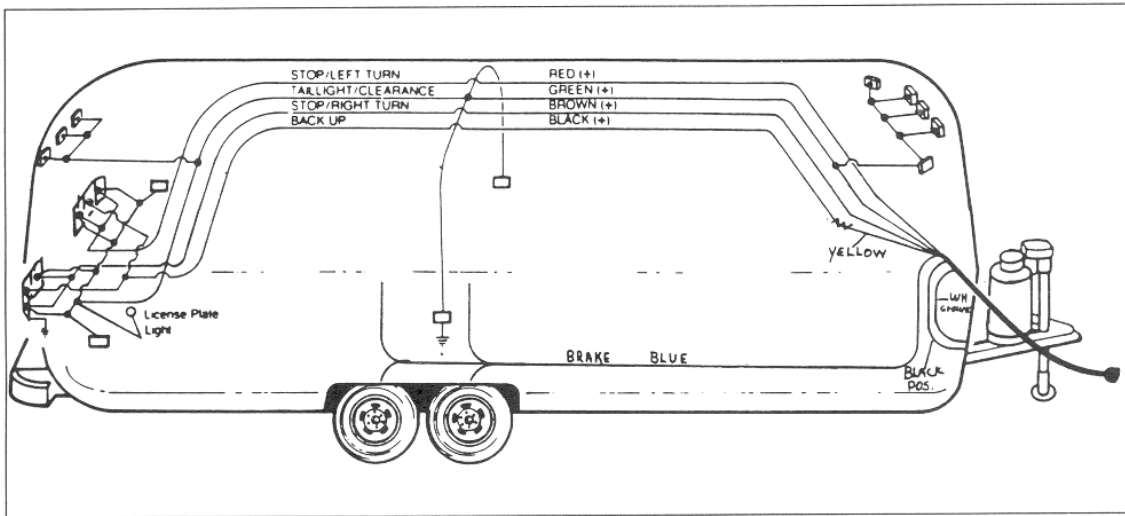

Note: The 7 way wire is spliced to the main harness in the front of the trailer.

One of these wires is not spliced onto a wire of the same color. It is the back up wire that is yellow in the cable and black in the harness.

22 Ft. International 12-Volt Layout

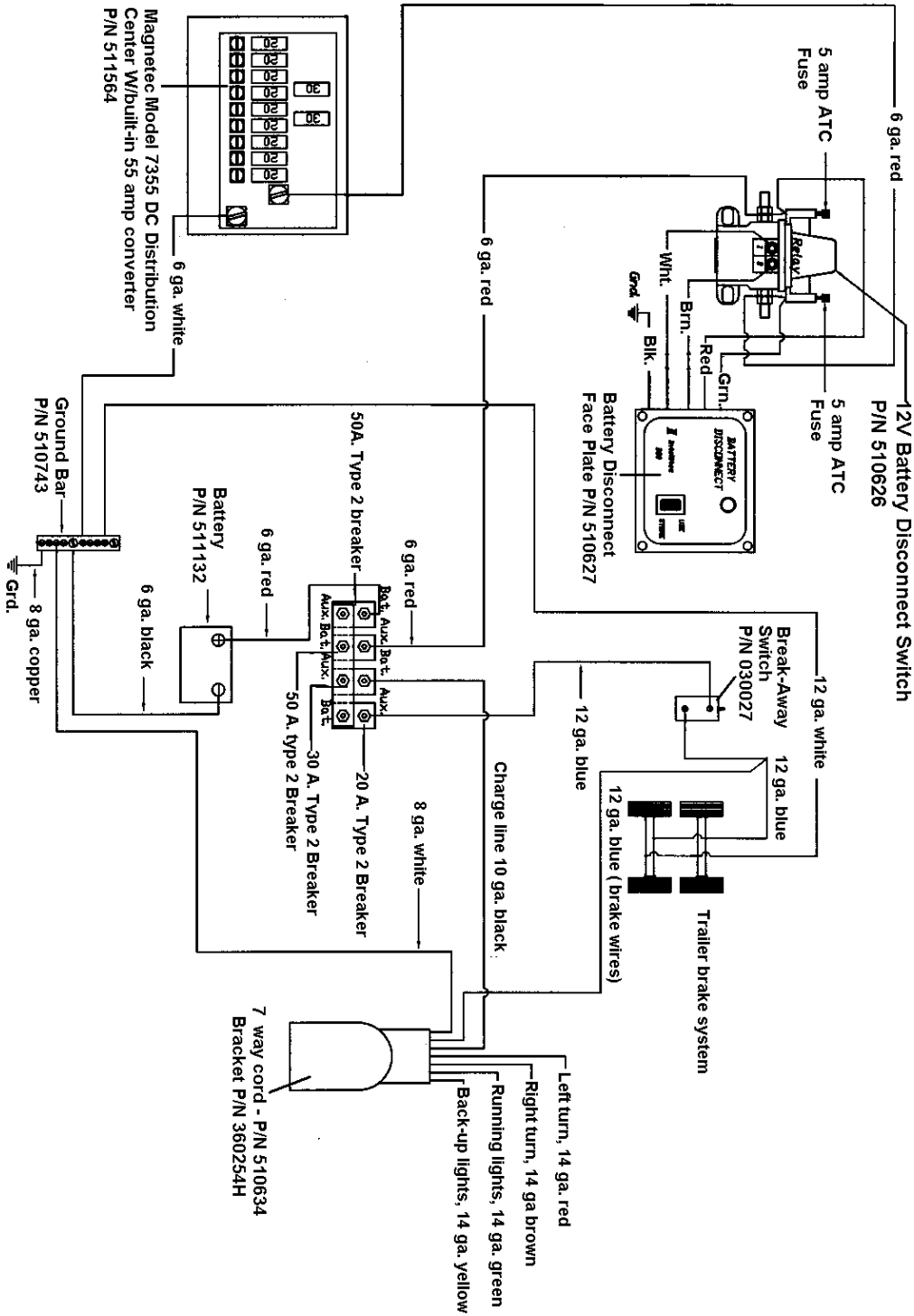

AIRSTREAM INTERNATIONAL TRAILER OWNERS MANUAL

12-VOLT INTERIOR

Distribution Panel, USA

The low voltage distribution panel is located in the MagneTec Series 7300 Power Center. Open the brown door to access the panel.

International & CCD Models

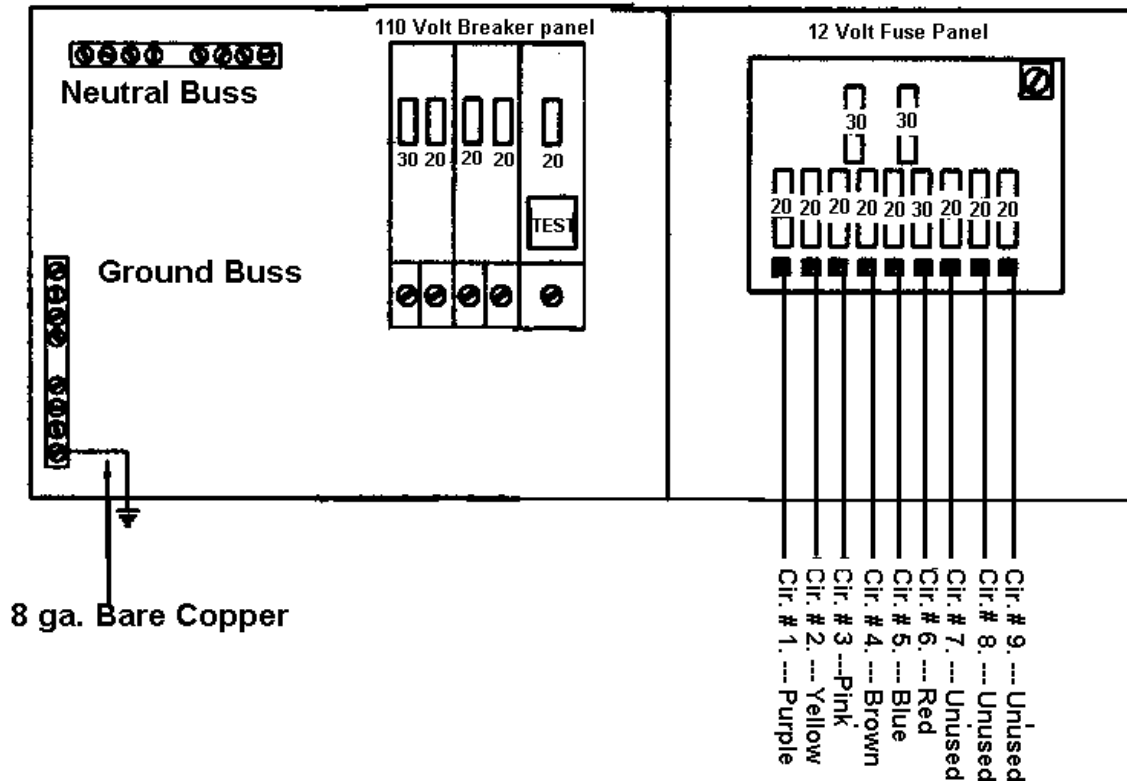

See 12-volt circuit assignments on next page.

AIRSTREAM INTERNATIONAL TRAILER OWNERS MANUAL

22 Ft. AIRSTREAM INTERNATIONAL CIRCUIT CHART & 12V. CALCULATIONS

CIRCUIT 1, 20 AMP. 12 GA. PURPLE

REAR GALLEY LOCKER LIGHT	02.88
BATH FAN	01.10
RADIO	05.00
1-BULB SHOWER LIGHT	01.44
REAR FANTASTIC FAN	<u>03.00</u>
TOTAL AMPS.	13.42

CIRCUIT 2, 20 AMP. 12 GA. YELLOW

SEWER LIGHT	01.00
(3) HALOGEN BEDROOM READING LIGHTS	02.70
STEP LIGHT	01.00
BEDROOM TV JACK	05.00
BEDROOM CEILING LIGHT	02.88
R.S. FORWARD COMP. LT.	<u>01.44</u>
TOTAL AMPS.	14.02

CIRCUIT 3, 20 AMP. 12 GA PINK

CS GALLEY LOCKER LIGHT	02.88
FURNACE	03.40
REFER LIGHT	01.00
RANGE HOOD LIGHT	00.70
RANGE HOOD FAN	01.10
#1,2, AND 3 CEILING LIGHTS	<u>08.64</u>
TOTAL AMPS.	17.72

CIRCUIT 4, 20 AMP. 12 GA. BROWN

FRONT FANTASTIC FAN	03.00
FRONT TV JACK/BOOSTER	05.00
WARDROBE LIGHT	<u>01.44</u>
TOTAL AMPS.	09.44

CIRCUIT 5, 20 AMP. 12 GA. BLUE

WATER HEATER IGNITION	01.00
MONITOR PANEL	00.00
WATER PUMP	07.00
2 BULB DINETTE LIGHT	02.88
2 HALOGEN READING LIGHTS	<u>01.80</u>
TOTAL AMPS.	12.68

CIRCUIT 6, 30 AMP. 10 GA. RED

POWER HITCH JACK (MOMENTARY DRAW)	20.00
HITCH LIGHT	<u>00.50</u>
TOTAL AMPS.	20.50

.5 AMP. BATTERY CHARGER
TOTAL AMP. DRAW 88.28

1ST 20 AMPS. @ 100% = 20.00 AMPS.
2ND 20 AMPS. @ 50% = 10.00 AMPS.
48.28 AMPS. @ 25% = 12.07 AMP.

GRAND TOTAL AMPS. 42.07

AIRSTREAM INTERNATIONAL TRAILER OWNERS MANUAL

22' INTERNATIONAL CCD TRAVEL TRAILER CIRCUIT CHART & 12V. CALCULATIONS

CIRCUIT 1, 20 AMP. 12 GA. PURPLE

DESK AREA SPOT LT.	00.90
BATH FAN	01.10
RADIO	05.00
1-BULB SHOWER LIGHT	01.44
REAR FANTASTIC FAN	03.00
GALLEY SPOT LT.	<u>00.90</u>
TOTAL AMPS	12.34

CIRCUIT 2, 20 AMP. 12 GA. YELLOW

SEWER LIGHT	01.00
(4) HALOGEN BEDROOM	
READING LIGHTS	03.60
PATIO LIGHT	01.00
BEDROOM TV JACK	<u>05.00</u>
TOTAL AMPS.	10.60

CIRCUIT 3, 20 AMP. 12 GA PINK

2 HALOGEN GALLEY	
LOCKER LIGHTS	01.80
FURNACE	03.40
REFER LIGHT	01.00
RANGE HOOD LIGHT	00.70
RANGE HOOD FAN	01.10
3 HALOGEN GALLEY	
LOCKER INDIRECT LTS.	02.70
3 HALOGEN DINETTE	
LOCKER READING LTS.	02.70
3 HALOGEN DINETTE	
LOCKER INDIRECT LTS.	<u>02.70</u>
TOTAL AMPS.	16.10

CIRCUIT 4, 20 AMP. 12 GA. BROWN

FRONT FANTASTIC FAN	03.00
TV JACK/BOOSTER	05.00
WARDROBE LIGHT	<u>01.44</u>
TOTAL AMPS.	09.44

CIRCUIT 5, 20 AMP. 12 GA. BLUE

WATER HEATER IGNITION	01.00
MONITOR PANEL	00.00
WATER PUMP	<u>07.00</u>
TOTAL AMPS	08.00

CIRCUIT 6, 30 AMP. 10 GA. RED

POWER HITCH JACK (MOMENTARY)	20.00
HITCH LIGHT	<u>00.50</u>
TOTAL AMPS.	20.50

.5 AMP. BATTERY CHARGER
TOTAL AMP. DRAW 77.48

1ST 20 AMPS. @ 100% = 20.00 AMPS.
2ND 20 AMPS. @ 50% = 10.00 AMPS.
37.48 AMPS. @ 25% = 09.37 AMPS.

Total 39.37 AMPS.

AIRSTREAM INTERNATIONAL TRAILER OWNERS MANUAL

22 Ft. International 510907-05 Tail light harness

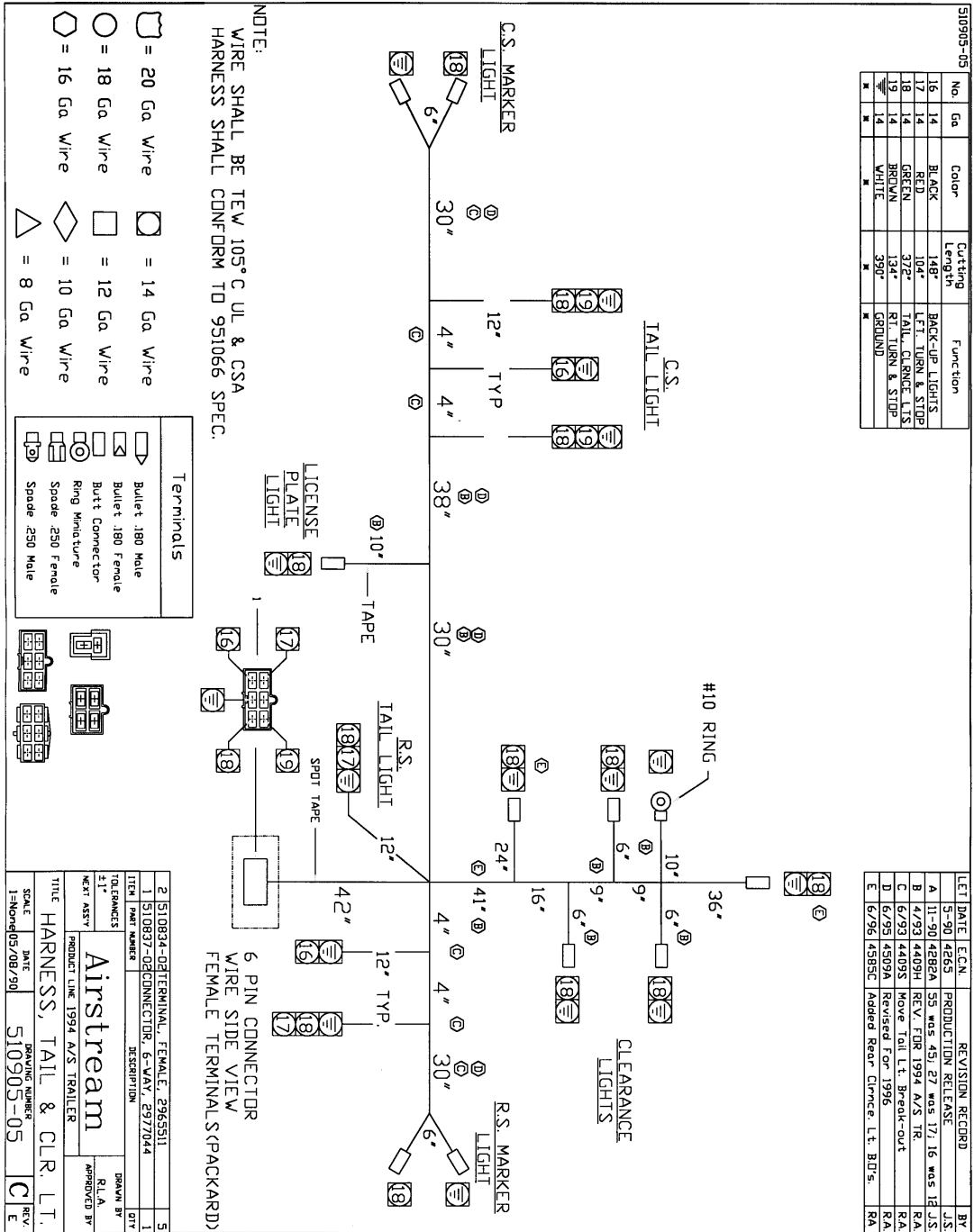

22 Ft. International
510907-01 Harness, Front Clearance Lights

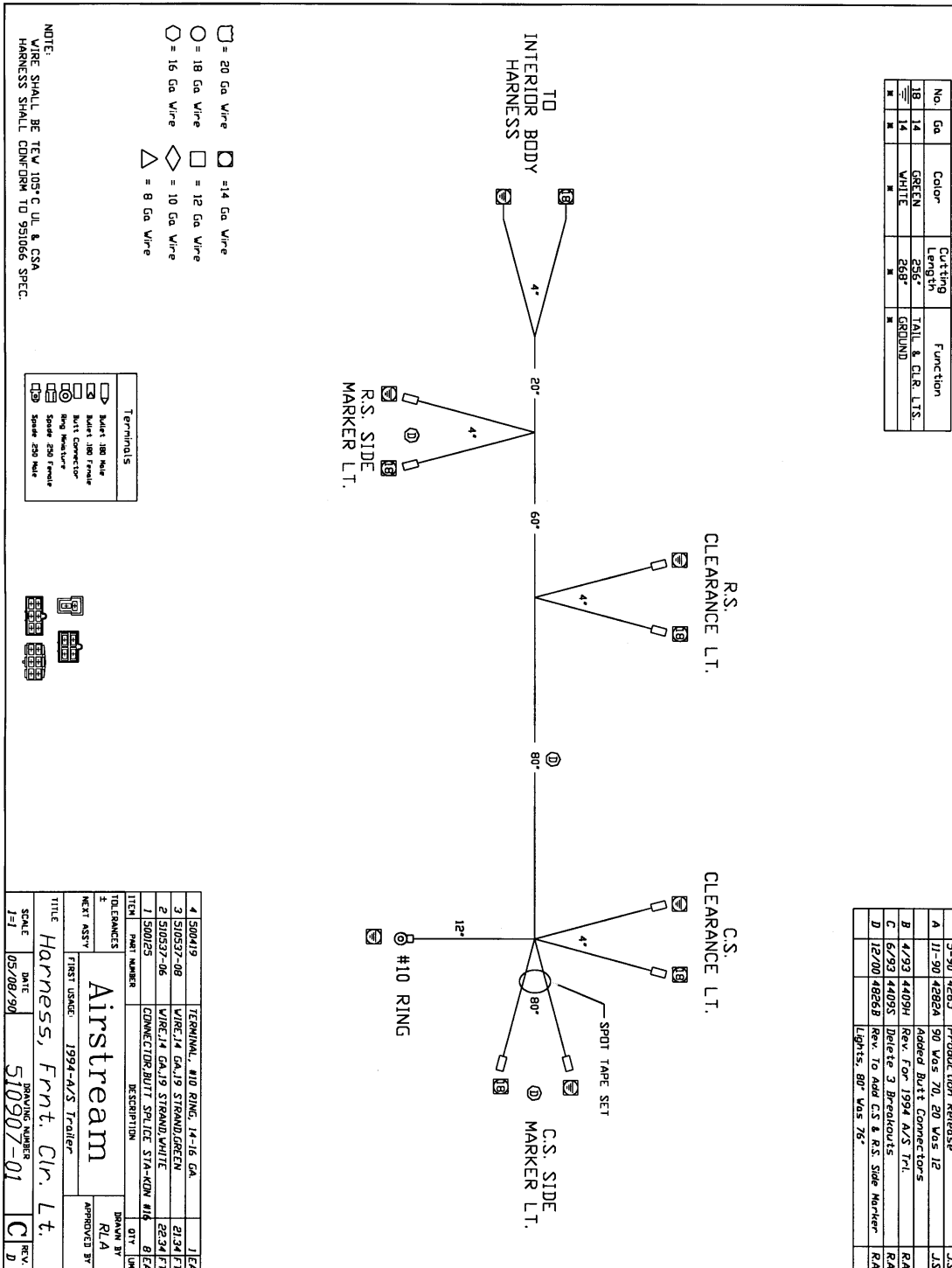

AIRSTREAM INTERNATIONAL TRAILER OWNERS MANUAL

22 Ft. International 511562 Interior Body Harness

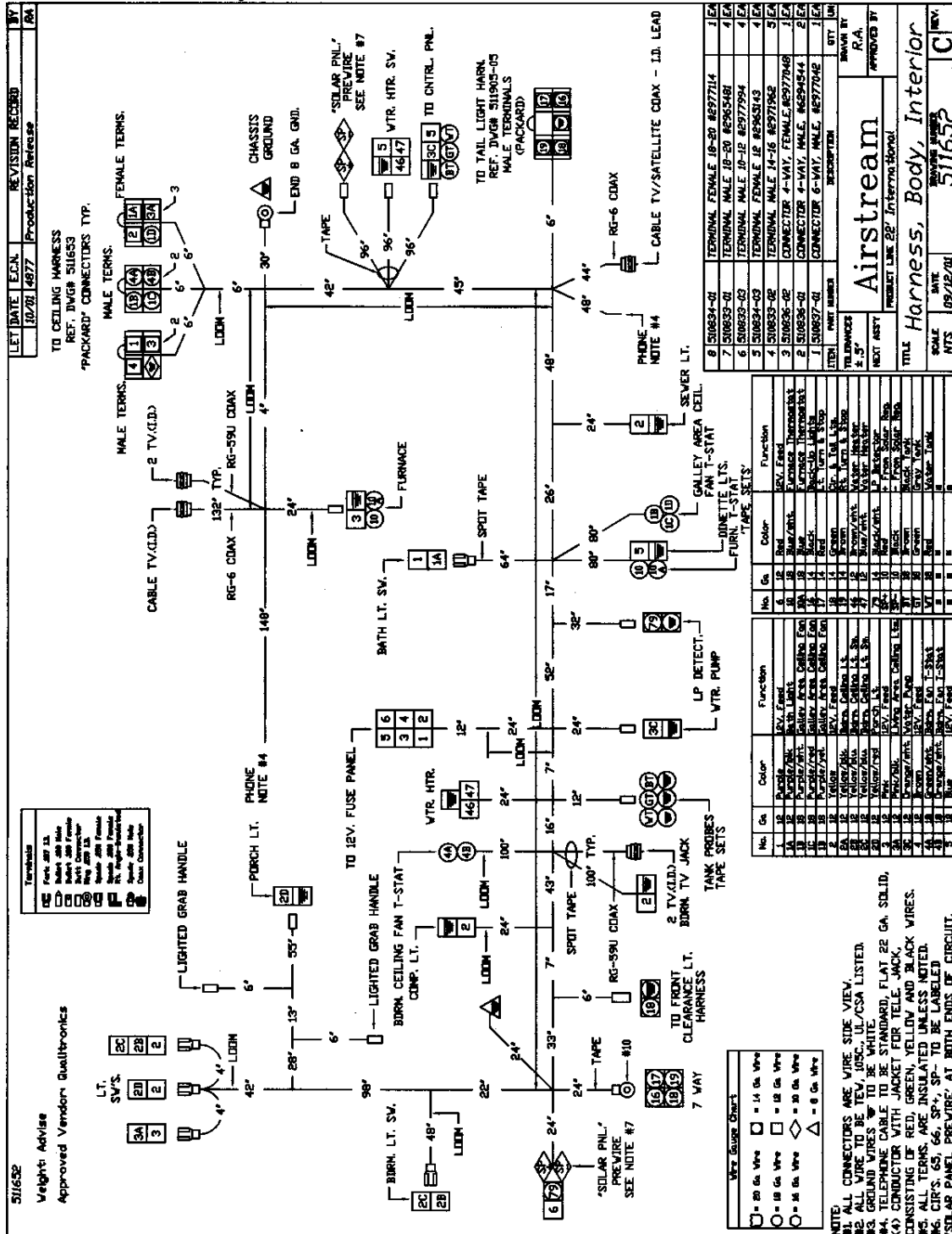

AIRSTREAM INTERNATIONAL TRAILER OWNERS MANUAL

22 Ft. International 511653 Ceiling Harness

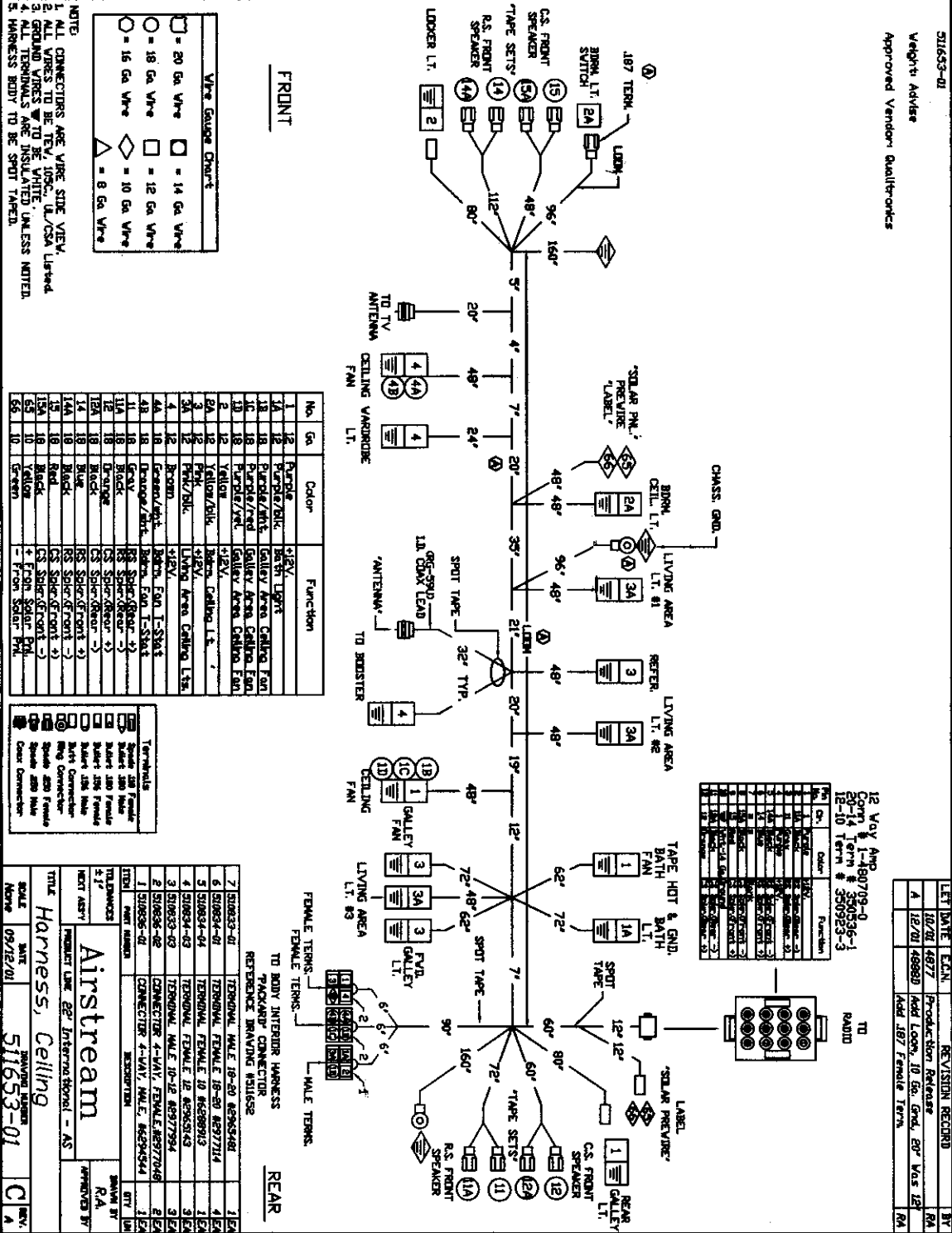

511653-01
 Weighted Advice
 Approved Vendor: Qualtronics

12 Volt Amp
 C-14 Term # 350536-1
 12-10 Term # 350523-3

No.	Color	Function
1	Black	SPK. LIGHT
2	Black	SPK. LIGHT
3	Black	SPK. LIGHT
4	Black	SPK. LIGHT
5	Black	SPK. LIGHT
6	Black	SPK. LIGHT
7	Black	SPK. LIGHT
8	Black	SPK. LIGHT
9	Black	SPK. LIGHT
10	Black	SPK. LIGHT
11	Black	SPK. LIGHT
12	Black	SPK. LIGHT
13	Black	SPK. LIGHT
14	Black	SPK. LIGHT
15	Black	SPK. LIGHT
16	Black	SPK. LIGHT
17	Black	SPK. LIGHT
18	Black	SPK. LIGHT
19	Black	SPK. LIGHT
20	Black	SPK. LIGHT
21	Black	SPK. LIGHT
22	Black	SPK. LIGHT
23	Black	SPK. LIGHT
24	Black	SPK. LIGHT
25	Black	SPK. LIGHT
26	Black	SPK. LIGHT
27	Black	SPK. LIGHT
28	Black	SPK. LIGHT
29	Black	SPK. LIGHT
30	Black	SPK. LIGHT
31	Black	SPK. LIGHT
32	Black	SPK. LIGHT
33	Black	SPK. LIGHT
34	Black	SPK. LIGHT
35	Black	SPK. LIGHT
36	Black	SPK. LIGHT
37	Black	SPK. LIGHT
38	Black	SPK. LIGHT
39	Black	SPK. LIGHT
40	Black	SPK. LIGHT

LET DATE	CLN.	REVISION	RECORDED
10/01/87	4872	Production Release	RA
12/01/88	4898B	Add Lamps, 10 Ga. Ground, 80' Was 12'	RA
		Add 187 Female Term.	RA

AIRSTREAM INTERNATIONAL TRAILER OWNERS MANUAL

TV ANTENNA

Manufacturer:
Winegard Company
3000 Kirkwood Street
Burlington, Iowa 52601
Phone: 800-843-4741

Raising Antenna to Operating Position

Turn elevating crank in "UP" direction until some resistance to turning is noted. Antenna is now in operating position. Check to make sure switch on front TV jack is on.

Rotating Antenna

Make sure antenna is in "UP" position. Pull down on directional handle with both hands until it disengages ceiling plate and rotate for best picture and sound on television set.

Lowering Antenna to Travel Position

Rotate antenna until pointer on directional handle aligns with pointer on ceiling plate.

 **WARNING:** Antenna must be in "down" position while traveling to prevent damage.

Turn elevating crank in the "Down" direction until resistance is noted. Antenna is now locked in travel position.

Checking Operation

1. Tune TV receiver to nearest station and rotate antenna for best picture and sound.
2. Turn off switch on power supply. Picture on TV receiver should be considerably degraded with the power off.

DO'S

1. Do check parking location for obstructions before raising antenna.
2. Do carefully raise, lower and rotate - if difficult, check for cause.
3. Do rotate slowly when selecting station and check fine-tuning on TV set to make sure it is properly adjusted.
4. Do lower antenna before moving vehicle.

DON'TS

1. Don't force elevating crank up or down. Check for cause of trouble.
2. Don't rotate directional handle hard against stops.
3. Don't travel with lift in up position.
4. Don't leave lift part way up or down.
5. Don't apply sealing compound or paint over top of base plate or anywhere on lift.

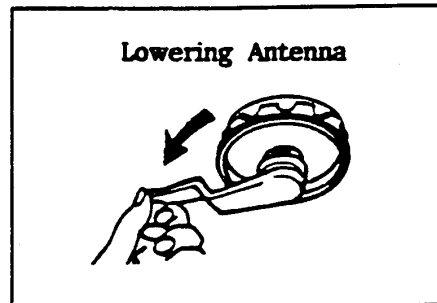
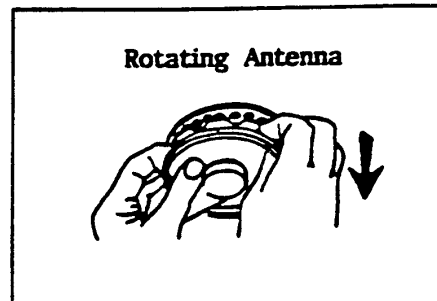
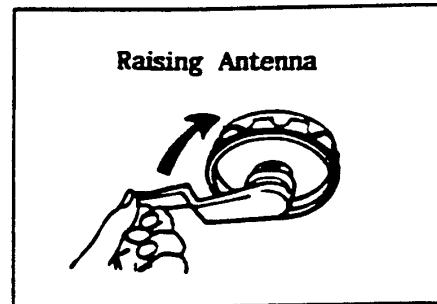

AIRSTREAM INTERNATIONAL TRAILER OWNERS MANUAL

Maintenance

Lubrication

To lubricate the elevating gear apply a liberal amount of silicone spray lubricant to the elevating gear with the lift in the down position, then run the lift up and down a few times to distribute lubricant over gears.

Lubricating Rotating Gear Housing

In the event that rotating the antenna becomes difficult, lubricating the bearing surface between the rotating gear housing and the base plate can restore normal operation. Any spray type silicone lubricant may be used.

Elevate antenna and remove setscrew from rotating gear housing as shown. Spray lubricant into hole and around edges of gear housing. Rotate gear housing until lubricant coats bearing surfaces and antenna rotates freely.

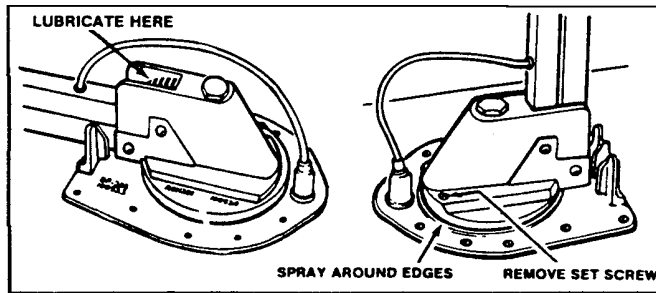

Elevating Shaft Worm Gear Assembly Replacement Procedure

NOTE: It is not necessary to remove the rotating gear housing (11) from the base plate (14) or remove the antenna from the roof to replace the shaft and gear assembly.

STEP 1: Lower antenna to travel position. Loosen set - screw on elevating crank (23); remove crank, spring (20), and directional handle (19).

STEP 2: Remove top retaining ring (5) from top pin (4) holding **top** elevating tube in rotating gear housing and remove pin.

STEP 3: Remove plug from top of rotating gear housing elevating gear (8) and remove elevating shaft assembly (10).

STEP 4: Cut new shaft to same length as one removed.

STEP 5: Lubricate worm gear on new elevating shaft assembly with spray silicone lubricant, make sure wave washer, flat washer and quad ring are on lower bearing and insert assembly in housing.

STEP 6: Install plastic plug in top of housing, re-engage elevating gear in worm gear, replace pin and retaining ring.

STEP 7: Replace directional handle, spring and elevating crank. Make sure setscrew contacts flat on shaft before tightening.

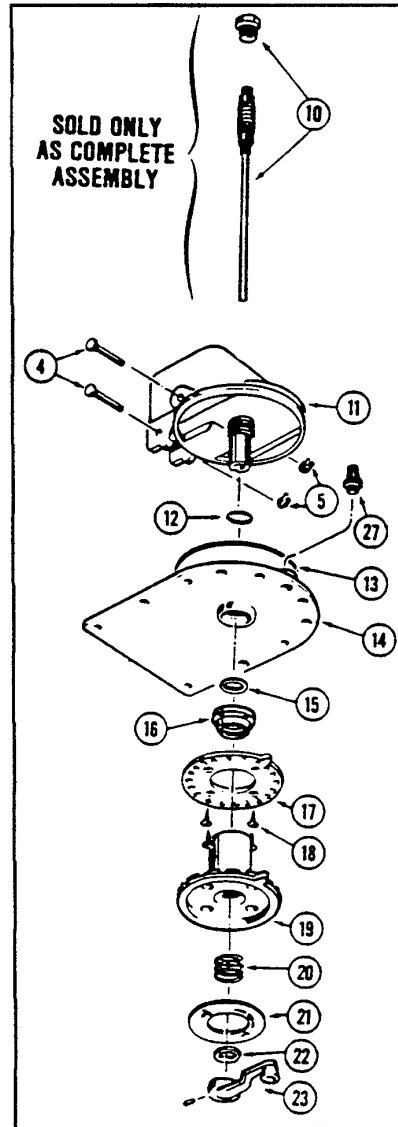

AIRSTREAM INTERNATIONAL TRAILER OWNERS MANUAL

PARTS DESCRIPTION

1. Antenna Head
2. LM-300 Leveling Mount
3. Boot, Coax Cable
4. Pin, Headed/Grooved
5. Ring, Retaining Snap
6. Spacer, Plastic
7. Grommet, Plastic
8. EG-87 Elevating Gear
9. Tube, Square Elevator
10. Elevating Shaft Assy
11. Housing, Rotating Gear
12. Ring Quad Seal
13. Bearing, Nylon
14. Housing, Base Plate
15. Bearing, Nylon
17. Plate, Ceiling
18. Screw
19. Handle, Directional
20. Spring, Handle
21. Decal, Crank Cover
22. Bearing, Nylon
23. Elevating Crank/Set Screw
27. Boot, Gear Housing
30. Bumper, Rubber
31. Screw

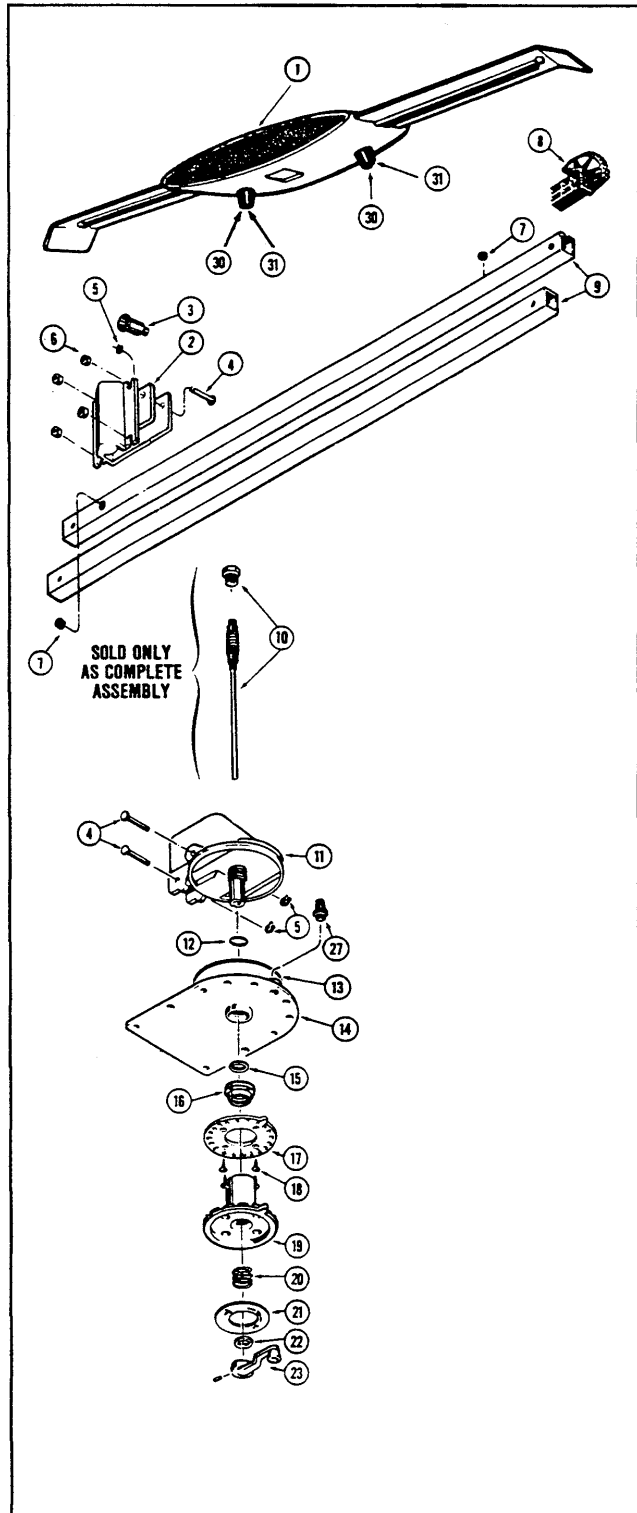

AIRSTREAM INTERNATIONAL TRAILER OWNERS MANUAL

COAXIAL CABLE WITH CABLE HOOK-UP

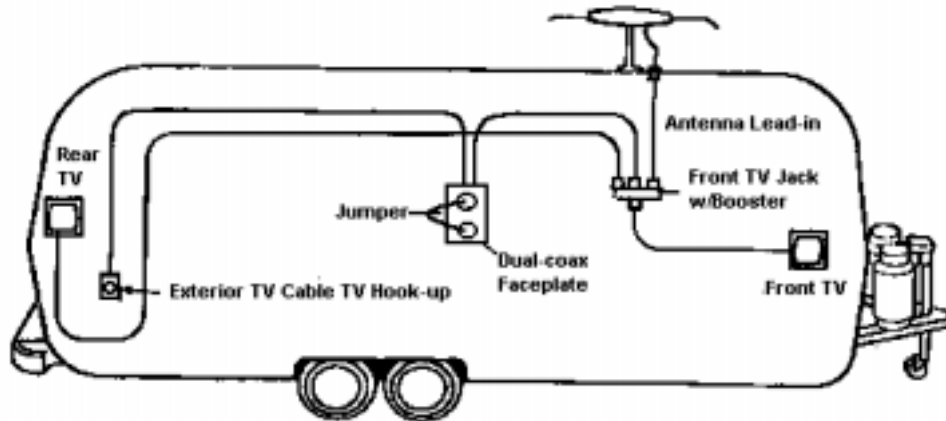

COAXIAL CABLE WITH SATELLITE ANTENNA

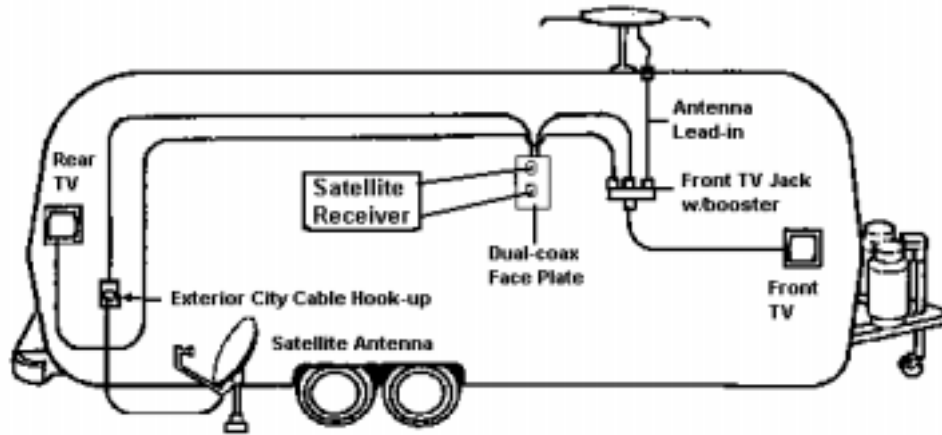

SATELLITE ANTENNA WIRING

If you compare the two previous drawings you'll see wiring for a satellite dish antenna is relatively simple.

Units have a faceplate with two coax cable hook-ups. It is located above the refrigerator cabinet on the AS model and under the desk on the 22 FT. CCD model. The faceplate has a small coax cable jumper running between the hook-ups to complete the cable TV circuit when in use. To install a satellite system use the following procedure:

1. Remove the jumper wire from the coax faceplate.
2. Hook a portable dish into the Cable TV receptacle in the roadside rear underbelly compartment. This feeds the dish signal to the input side of the faceplate.
3. Install the satellite receiver input and output into the dual coax faceplate.

To return to a cable TV system, remove the satellite receiver from the faceplate and reinstall the jumper cable.

AIRSTREAM INTERNATIONAL TRAILER OWNERS MANUAL

SOLAR PANEL PRE-WIRE

WIRE SIZE: 10 Ga.

WIRE COLOR:

1. Positive lead from battery to solar meter/charge controller is RED.
2. Negative lead from battery to solar meter/charge controller is BLACK.
3. Positive lead from solar meter/charge to solar panel is YELLOW (like the sun).
4. Negative lead from solar meter/charge to solar panel is GREEN (like the earth).

WIRE LOCATIONS

1. The positive (red) and negative (black) leads that connect to the battery are located under the bed. The red wire goes to the 12-volt + bus bar and the black to the battery 12-volt ground upon installation.

CAUTION: The red wire must be fused with a 10-amp in-line fuse at the 12-volt positive.

2. The positive (red) and negative (black) leads from the battery that connect to the solar meter/charge controller are located in the galley roof locker behind the radio.

3. The positive (yellow) and negative (green) leads that connect to the solar, meter/charge controllers are located in the galley roof locker behind the radio. These wires are in the same bundle as the red and black battery leads.

4. On the AS model the positive (yellow) and negative (green) leads for the solar panel are found above the bedroom ceiling light taped to the bottom of the roof skin. On the CCD they are located beside the bedroom roof vent taped to the bottom of the roof skin.

NOTE: All wires are identified at all locations.

BATHROOM EXHAUST FAN ASSEMBLY

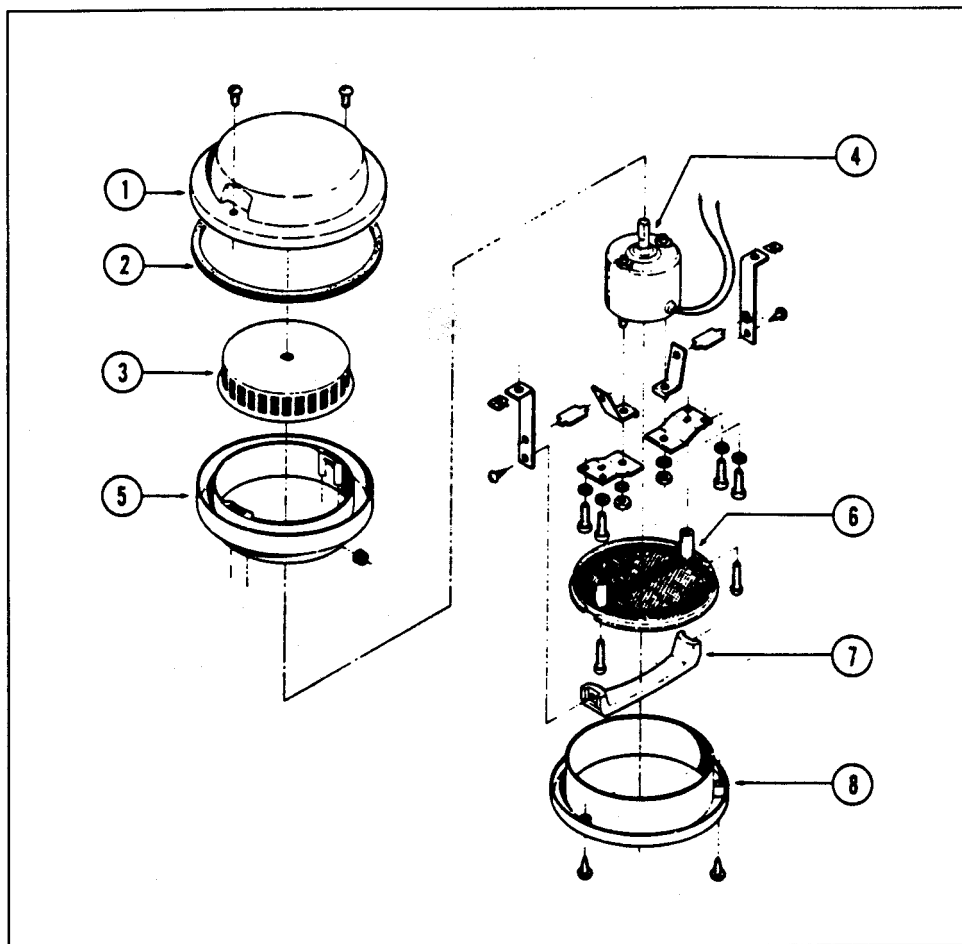

1. Cover Assy w/gaskets
2. Gasket Assy
3. Blower wheel Assy
4. Motor Assy
5. Ring Body Assy
6. Grille Assy
7. Handle Assy
8. Trim Ring Assy

Removal and Replacement

1. Working from the outside top of trailer, remove the screws holding the fan protective cap, and remove the cap.
2. Remove the 6 screws securing the fan flange to the outer skin.
3. Pull the fan out to the extent of the wiring harness and unplug the harness.
4. Remove the fan assembly,
5. To install, reverse the removal procedures

AIRSTREAM INTERNATIONAL TRAILER OWNERS MANUAL

MONITOR PANEL

SeeLevel RV Gauge

Garnet Instruments LTD.
284 Kaska Road
Sherwood Park, Alberta
Canada T8A 4G7
Toll Free North America: 1-877-RVGAUGE (784-2843)
Email: service@rvgauge.com

SYSTEM DESCRIPTION

The **SeeLevel II** Tank Monitor represents a massive leap forward in level measurement technology for the Recreational Vehicle industry. The SeeLevel has a combination of features, accuracy, reliability, and diagnostic capability that have never been available before.

The **SeeLevel II** Version A will monitor RV battery voltage, fresh water holding tank level, grey and black sewer tank levels, one LPG tank, and the inside temperature. The information is displayed on a 3 digit alpha-numeric LED display. In addition, the system can display the operating characteristics of each of the tank sending units, giving it unsurpassed diagnostic capability.

Version A also provides control for the water pump and water heater via front Panel rocker switches.

The **SeeLevel II** consists of a display unit that mounts inside the RV where it can be easily viewed, and a sender panel that sticks to the side of the holding tank. Two-conductor wiring is used to connect each sender panel to the display.

The Sender. Each sender panel is a flexible self-adhesive printed circuit board that is adhered to the side of the holding tank. The sender panel can be cut to length to match the height of the tank, and it auto calibrates itself so that it can read from Empty to Full regardless of the height of the tank. The sender scans the water level through the tank wall using advanced digital techniques programmed into the sender microprocessor. When the sender transmits the water or sewer level information to the display, it sends a digital code that has built in error detection, making it highly unlikely for the display to read an incorrect level, even if the wiring is marginal. In addition to the level, the sender also transmits diagnostic information about its operation. This information can be used to determine if there is buildup of sludge on the inside of the tank, or to determine if the sender is damaged or delaminating from the side of the tank. If sludge buildup in the tank becomes extreme, the gauge will cease to operate (the tank will always read empty), so by monitoring the signal power the tank can be cleaned before the buildup gets excessive.

The Display. The display receives the information from the three sender panels via two wire cables. When the front panel button for a particular tank is pressed, the display powers up and displays the level for that tank. If the button is pressed and released, the display will show the level for about 5 seconds and then shut down automatically. If another button is pressed before the display shuts down, then the new level will immediately be shown. If the same button is pressed twice, the display will hold on that tank and continue to show updated levels for 5 minutes before shutting off. This allows the user to monitor the filling or draining of a tank. By pressing two buttons at once, the diagnostic functions can be accessed. If the wiring is disconnected, cut, or if the sender panel is damaged, then the display will indicate the appropriate fault condition.

AIRSTREAM INTERNATIONAL TRAILER OWNERS MANUAL

A rocker switch on the front panel can control the fresh water pump, and an LED indicates when the pump is on.

The system also shows the RV battery voltage by measuring the voltage, which powers the display.

The inside temperature is measured with a digital temperature sensor mounted to the inside of the display panel. It reads in degrees Fahrenheit and is accurate to within 3 degrees. Any sensor failure will be shown on the display.

With these diagnostic features and the digital nature of the tank level sensing technology, it is almost impossible for the system to indicate an incorrect water level, and in the very unlikely event it does occur, the user can verify what is happening with the diagnostic information.

OPERATING INSTRUCTIONS

The display is the only system component that is accessed by the user. All user input to the display is done using the six buttons along the bottom of the display. Operation of the display is as follows:

To read a tank level:

1. Press the button corresponding to the tank to be checked and release it, the display will turn on and show the level in percent on the LED display. If no other button is pressed, then the display will shut itself off after about 5 seconds.
2. If another button is pressed before the 5 second time is up for the first button, the display will immediately switch to showing the new level. The 5 second timeout is restarted every time a button is pressed.
3. To continuously display a reading, press and release the desired button, and then press the same button a second time. While the button is held down for the second time, the display will show "hid". When the button is released, the display will be in hold mode, which is indicated by the decimal point on the right hand side turning on. While the display is in the hold mode it will recheck the level once per second so the user can watch the level change while the tank is being filled or drained. The display will automatically shut off after 5 minutes in hold mode. To end the hold mode before the 5 minutes is up, press the same button again, while the button is held down the display will show "OFF". When the button is released the display will turn off.
4. If a sender or its wiring is not operating properly, the following codes are shown on the display:
 - a. If a sender is unresponsive or there is an open circuit in the wiring so that the sender is not connected, the display will indicate an open circuit by showing "OPn" on the LED display.
 - b. If a sender is shorted or there is a short circuit in the wiring, the display will indicate an short circuit by showing "Sht" on the LED display.
 - c. If a sender is sending bad data, there is damaged wiring, or if there is electrical interference, the display will indicate a data error by showing "Err" on the LED display.

AIRSTREAM INTERNATIONAL TRAILER OWNERS MANUAL

d. If the display has been programmed for a single sender, and the sender has been programmed as a bottom sender, the display will show "bot". If the sender has been programmed as a top sender, the display will show "toP".

e. If the display has been programmed for 2 stacked senders for tall tanks, and only the bottom sender is working and the top one is not, then the display will show "ntP" indicating that no top sender is being received. If the top is working but no bottom sender is being received, then the display will show "nbo". If neither sender is working, then the display will show "OPn". If a sender has not been programmed for top or bottom operation, the display will show "sin" indicating that a single sender is connected.

f. For the LPG tank, "Opn" indicates an open circuit in the wiring or a bad resistance sender in the LPG tank. If there is a short in the wiring, the display will read zero all the time.

To read the battery voltage:

1. Press the BATTERY button and release it, the display will turn on and show the battery voltage on the LED display.
2. If no other button is pressed, then the display will shut itself off after about 5 seconds. If the BATTERY button is held down, the display will continuously recheck the voltage and show the updated value. The reading may flicker back and forth between two values, for example, 12.6 and 12.7 volts. This is normal behavior for a digital voltage display.
3. If another button is pressed before the 5 second time is up for the BATTERY button, the display will immediately switch to showing the value for the new button. The 5 second timeout is restarted every time a button is pressed.

To read the inside temperature:

1. Press the TEMP button and release it, the display will turn on and show the temperature in degrees Fahrenheit on the LED display. The temperature sensor is mounted just behind the display panel and will read the temperature at that point. If no other button is pressed, then the display will shut itself off after about 5 seconds.
2. If another button is pressed before the 5 second time is up for the TEMP button, the display will immediately switch to showing the value for the new button. The 5 second timeout is restarted every time a button is pressed.
3. To continuously display the temperature, press and release the TEMP button, and then press the TEMP button a second time. While the button is held down for the second time, the display will show "hld". When the button is released, the display will be in hold mode, which is indicated by the decimal point on the right hand side turning on. While the display is in the hold mode, it will recheck the temperature once per second. The display will automatically shut off after 5 minutes in hold mode. To end the hold mode before the 5 minutes is up, press the TEMP button again, while the button is held down the display will show "OFF". When the button is released, the display will turn off.
4. If the temperature sensor fails so that it cannot communicate with the display microprocessor, the display will indicate this by showing "Err" on the LED display.

AIRSTREAM INTERNATIONAL TRAILER OWNERS MANUAL

To review the sender diagnostics:

1. The sender diagnostics can be reviewed periodically to check for any degradation of the tank senders. If a sender appears to be malfunctioning, reviewing the diagnostics should be the first step. Note that there are no diagnostics for the LPG, battery voltage, or temperature.
2. There are two diagnostics for the senders: the signal power, and the sender height.
 - a. The signal power is an indication of how much signal is being transmitted through the tank wall and picked up by the receive part of the sender. If the signal power is too low, it can indicate a sender which is detached from the tank, excessive buildup on the inside of the tank, bad wiring to the sender, low battery voltage, or a defective sender. The minimum signal power for proper operation is 5%.
 - b. The sender height is simply the length of the sender(s) in inches. The senders auto calibrate to the length that they are cut, so this diagnostic allows the user to confirm the length and to make sure that the auto calibration is working properly.
3. To check the diagnostics, press and hold the button for the tank to be checked, the display will show the level for that tank.
4. While continuing to hold down the button for the tank, press the **BATTERY/DIAGNOSTICS** button, the display will show "dIA" while the buttons are held down, then release both buttons. The display will change to showing the signal power diagnostic. This is indicated by a "P" showing on the left digit, for example "P26" indicates a 26% signal power.
5. Press the tank button again (the display will show "dIA" while the button is held down), the display will change to showing the sender height. This is indicated by a small "h" showing on the left digit, for example "h23" indicates that the senders are 23 inches high.
6. Press the tank button again to turn off the display (the display will show "OFF" while the button is held down). If at any time a button is not pressed then the display will automatically shut off after 5 seconds.

Monitor Wire Color	Function
Red	+ 12V power input to gauge, can be also source of power for the pump
Black	Ground
Yellow	Pump +12V power
Green	LPG Sender
Brown	Black water tank sender
Gray	Gray water tank sender
Blue	Fresh water tank sender

AIRSTREAM INTERNATIONAL TRAILER OWNERS MANUAL

DISPLAY CALIBRATION

To calibrate the temperature readout to degrees F or degrees C:

1. Turn off the 12V RV power to the display. Hold down the BATTERY and the TEMP button and turn on the 12V power to the display.
2. The display will turn on and will show "F-C" to indicate the choice between Fahrenheit and Celsius. When this occurs release the buttons.
3. The display will now show "°C" or "°F", based on what is currently programmed into the display.
4. To alternate between Fahrenheit and Celsius, press the TEMP button, each time the button is pressed the display will switch to the other temperature.
5. When the display shows the correct temperature mode, turn off the 12V power, the calibration is complete.

To calibrate the number of senders for each tank:

1. This should only be done at the time of installation; there is no reason to change this afterward. Turn off the 12V RV power to the display. Hold down the BATTERY and the tank button (FRESH, GREY, or BLACK) and turn on the 12V power to the display.
2. The display will turn on and will show "FrS" if doing the number of senders for the fresh tank, "GrS" if doing the grey tank, or "bLS" if doing the black tank. When this occurs release the buttons.
3. The display will now show "1SE" or "2SE", based on what is currently programmed into the display. These are the only two options; the display will not work with more than two senders per tank.
4. To change the number of senders, press the tank button, each time the button is pressed the display will switch to the other number.
5. When the display shows the correct number of senders, turn off the 12V power, the calibration is complete for that tank. Each tank will need to be calibrated individually using this procedure.

The battery voltage is calibrated at the factory; this should never need to be changed.

TANK WIRING COLORS

FRESH WATER TANK: Ground wire color WHITE connected to BLACK wire of sender.
Sender wire color RED connected to YELLOW wire of sender.

BLACK WATER TANK: Ground wire color WHITE connected to BLACK wire of sender.
Sender wire color BROWN connected to YELLOW wire of sender.

GRAY WATER TANK: Ground wire color WHITE connected to BLACK wire of sender.
Sender wire color GREEN connected to YELLOW wire of sender.

AIRSTREAM INTERNATIONAL TRAILER OWNERS MANUAL

110-VOLT ELECTRICAL SYSTEM

City Power

The 110-volt electrical system provides power to operate the air conditioner, converter and 110-volt receptacles for portable appliances. The power is routed through the 110-volt city power flexible cord to the 110-volt distribution panel inside the power converter door, and then is distributed to each appliance or receptacle. 110-volt layout diagrams are shown later in this section.

A 110-volt exterior outlet for is located on the curbside exterior wall behind the wheels.

CAUTION: When operating with city power make very certain that the service is 110 volt and not 220 volt.



WARNING: When the three-pronged plug can be used there will be no problems with proper polarity or grounding.

In some older parks and other locations where three pronged outlets are not available, certain precautions to insure proper grounding and polarity must be taken. These precautions are listed below:

1. Attach the three-pronged plug to a two-pronged adapter. The third conductor line of this adapter has a short wire lead, which must be grounded.
2. For proper grounding connect the short ground lead to a grounded outlet box or to a cold water pipe. When no water pipe is available drive a metal rod two feet into the ground and attach the ground lug to it, thus providing the unit with proper grounding.

To operate self-contained, simply disconnect the power supply cable.

When your trailer is hooked up to 110 volt AC, the converter system automatically charges the trailer batteries with the battery disconnect switch in the “use” (on) position and, if the 7-way cord is hooked up, your automobile battery as well. The speed and degree of charge depends on how much power is used for lights and appliances, as only the surplus goes to charging the battery. If you are making an extended stay, then you should keep your trailer hooked up to a 110 volt current if it is available.

While you are connected to the 110-volt receptacle the wiring is protected by circuit breakers in the breaker panel. The circuit breaker panel for the 110-volt system is located in the converter. Open the brown decorative converter door under the dinette. **In the event of a failure of a 110-volt circuit, first check your trailer circuit breakers and the breaker for the outlet your trailer shoreline cord is plugged into.** If a breaker continues to trip after you have reset it several times, your circuit may be overloaded with appliances or there may be a short in the circuit. Try lessening the load on the circuit. Perhaps an electric griddle, hair dryer, or an electric heater can be turned off. If that does not solve the problem consult an Airstream Service Center.

All wire, components, and wiring methods conform to federal and state requirements.

AIRSTREAM INTERNATIONAL TRAILER OWNERS MANUAL

GROUND FAULT CIRCUIT INTERRUPTER (GFCI)

Many states require trailers which are sold in their state, and which have exterior 110 volt receptacles, to have a ground fault circuit interrupter.

Trailers manufactured for sale in these states have type THQL 15 amp GFCI breakers installed on the general circuit, since the exterior breaker is on this circuit. The breaker replaced the standard TQL-15 amp breaker.

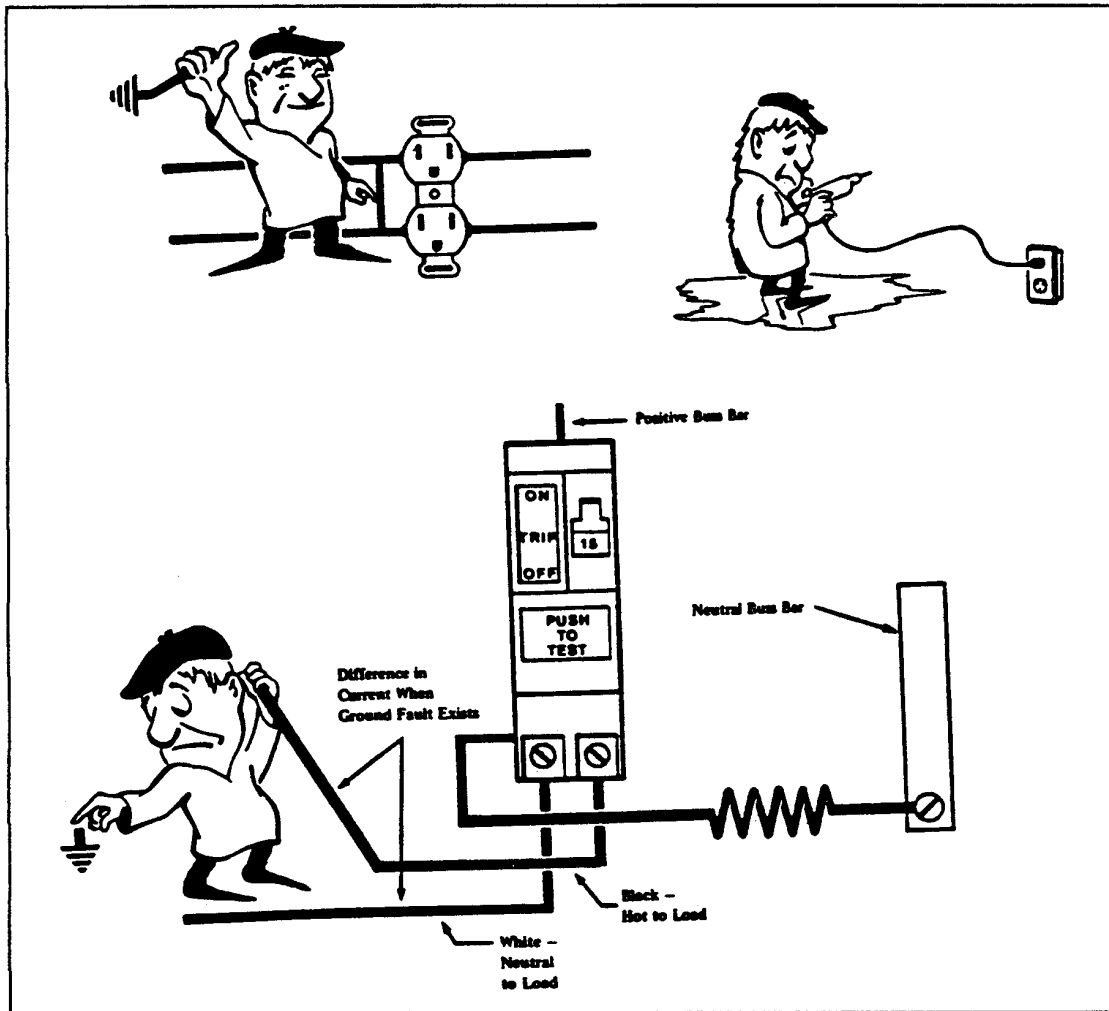

When properly installed, the GFCI circuit breaker provides reliable overload and short circuit protection PLUS protection from Ground Faults that might result from contact with a "HOT" load wire and ground.

IMPORTANT NOTE: The GFCI circuit breaker will NOT reduce shock hazard if contact is made between a "HOT" load wire and a neutral wire or 2 "HOT" load wires.

Each GFCI circuit breaker is calibrated to trip with a ground current of 5 milliamperes or more. Since most persons can feel as little as 2 milliamperes, a distinct shock may be felt if the need for protection exists. However, the shock should be of such short duration that the effects would be reduced to less than the normally dangerous level. However, persons with acute heart problems or other conditions that can make a person particularly susceptible to electric shock may still be seriously injured.

AIRSTREAM INTERNATIONAL TRAILER OWNERS MANUAL

While the GFCI circuit breaker affords a high degree of protection, there is no substitute for the knowledge that electricity can be dangerous when carelessly handled or used without reasonable caution.



WARNING: The GFCI circuit breaker provides protection only to the circuit to which it is connected. It does NOT provide protection to any other circuit.

OCCUPANT:

Make this test each month and record the date on the chart.

1. With handle B in "ON" position, press PUSH TO TEST button A.
2. Handle B should move to TRIP position, indicating that GFCI breaker has opened the circuit.
3. To restore power move handle B to "OFF" and the to "ON"

Important: If handle B does not move to TRIP position when test button is pressed, the GFCI breaker protection is not complete. If this happens, replace GFCI breaker.

	JAN	FEB	MAR	APR	MAY	JUN	JUL	AUG	SEP	OCT	NOV	DEC
2002												
2003												
2004												
2005												

110-Volt Wiring Diagrams

22 Ft. International AS 110-Volt Layout

22 Ft. CCD 110-Volt Layout

22 Ft. International AS & CCD 110-volt Breaker assignments

AIRSTREAM INTERNATIONAL TRAILER OWNERS MANUAL

22 FT. International AS 110-Volt Layout

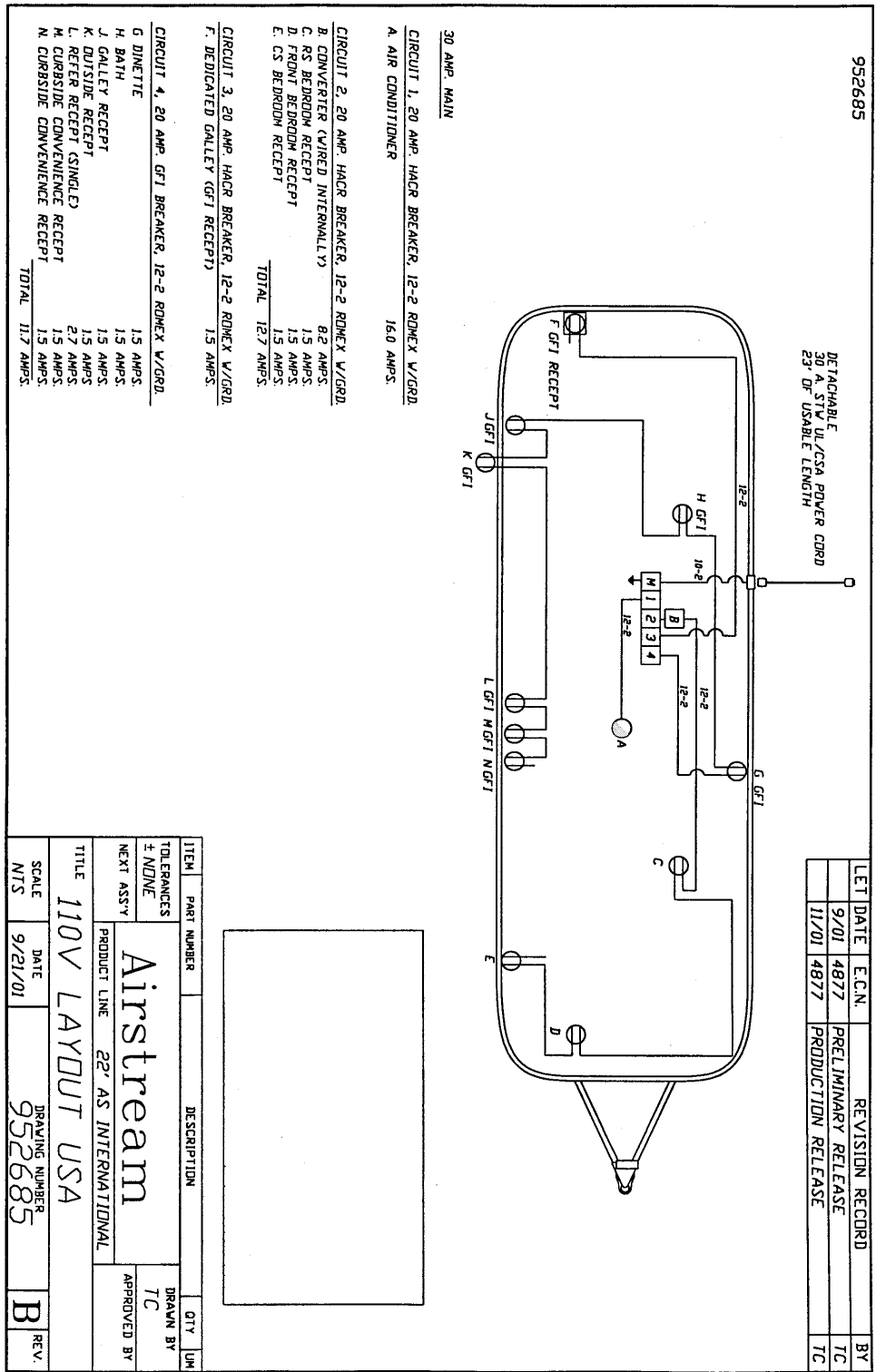

ITEM	PART NUMBER	DESCRIPTION	QTY	U/M
TOLERANCES ± NONE				
NEXT ASSY				
TITLE		DRAWN BY		
110V LAYOUT USA		TC		
SCALE		APPROVED BY		
9/21/01		B		
DATE		REV.		
9/21/01		B		
DRAWING NUMBER		REV.		
952685		B		

22 FT. International CCD 110-Volt Layout

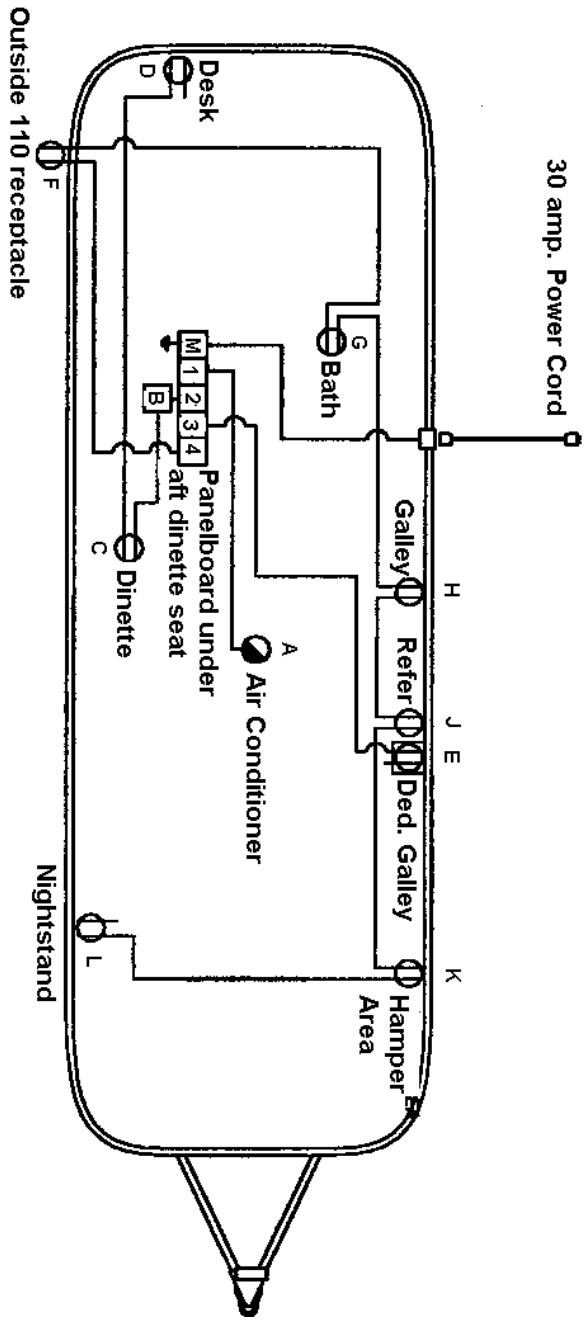

22' CCD 110-Volt Layout
952687

30 Amp. Main

Circuit 1, 20 amp, HACR Breaker, 12-2 Romex w/ground		Circuit 4, 15 Amp, GFI Breaker, 12-2 w/Ground	
A. Air Conditioner	16.0 Amps.	F. Outside Recept	1.5 Amps.
Circuit 2, 15 Amp, HACR Breaker, 12-2 Romex w/Ground		G. Bath Recept	1.5 Amps.
B. Converter (Wired Internally)	8.2 Amps.	H. Galley Recept	1.5 Amps.
C. Dinette Recept	1.5 Amps.	J. Refer Recept (Single)	2.7 Amps.
D. Rear Desk Recept	1.5 Amps.	K. Hamper Area Recept	1.5 Amps.
	Total	L. Nightstand Recept	1.5 Amps.
	11.2 Amps.	Total	10.2 Amps.
Circuit 3, 15 amps, HACR Breaker, 12-2 Romex w/Ground			
E. Dedicated Galley (GFI Recept)	1.5 amps.		

AIRSTREAM INTERNATIONAL TRAILER OWNERS MANUAL

22 ft. International AS & CCD

110-Volt Breaker Assignment

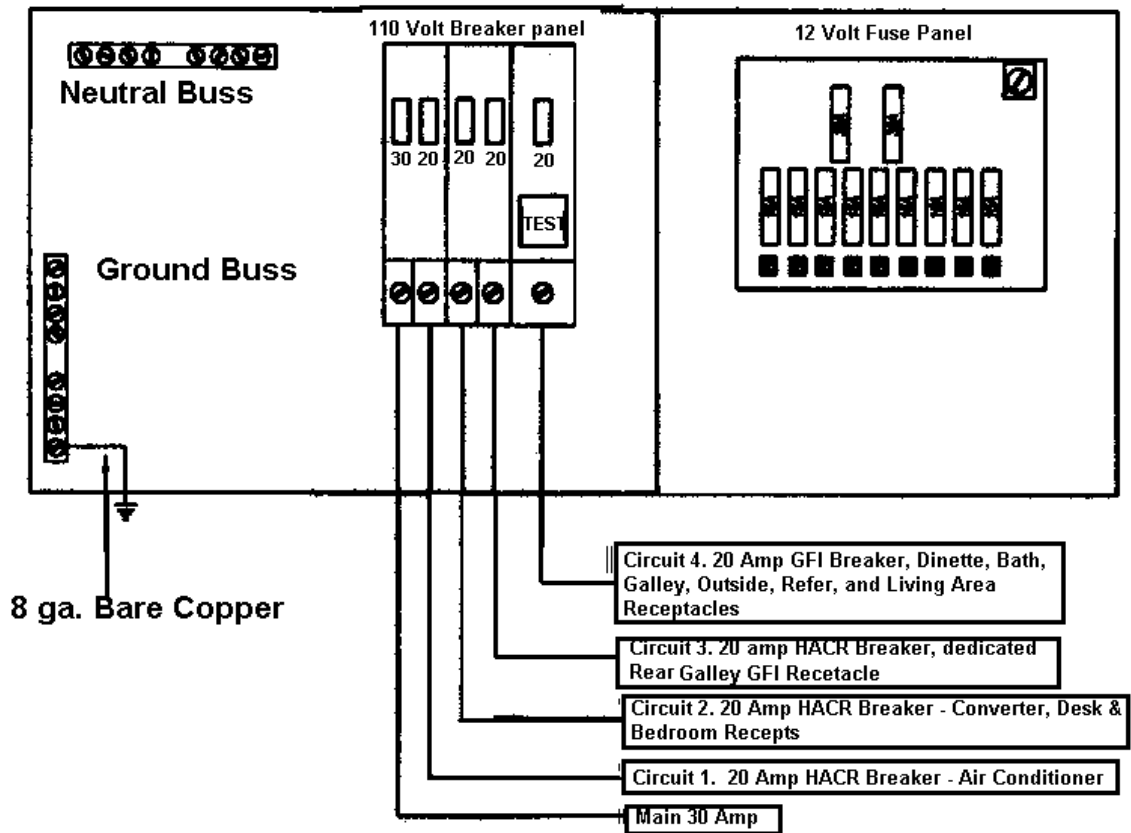

AIRSTREAM INTERNATIONAL TRAILER OWNERS MANUAL

APPLIANCES



WARNING: The operation manual for all appliances are included with the owners packet. Their manuals may contain specialized warnings and cautions specific to your appliances that should be reviewed prior to operating the appliance. If a manual is missing and has not been provided with your trailer, contact the appliance manufacturer, your Airstream Dealer, or Airstream Customer Service to obtain it.



WARNING: Most LP gas appliances used in recreational vehicles are vented to the outside of the vehicle. When parked close to a gasoline pump, it is possible that gasoline fumes could enter this type of appliance and ignite the burner flame, CAUSING A FIRE OR AN EXPLOSION.

AIR CONDITIONER

Manufacturer:

Dometic Sales Corporation
2320 Industrial Parkway P.O. Box 490
Elkhart, IN 46515
Phone: 219-295-5228

Note: Review the air conditioning literature supplied in your Owner's Packet before proceeding,

The roof air conditioner used on Airstream trailers is one of the most popular on the market today. In your Owner's Packet is a set of literature covering all operating and maintenance instructions. If the literature is misplaced please contact the air conditioner manufacturer or your Airstream dealer for replacement.

The voltage to the air conditioner is critical. We commonly refer to 110 or 120 volts, but a check with a voltmeter may find voltage much lower. Your air conditioner will probably not function if the current drops below 105 volts. Low voltage is usually associated with older or poorly maintained trailer parks, but many people have found their homes, built only twenty or thirty years ago, may not be capable of operating the air conditioner on some receptacles, Parking your trailer so the power cord can be plugged into a receptacle close to the fuse or circuit breaker box can alleviate the problem. Avoid extension cords and adapters whenever possible. If an extension cord must be used it should be as short and heavy as possible to provide the most current to the air conditioner.

If high temperatures are expected, you should make an effort to park in a shaded area. Starting the air conditioner early in the morning also helps. It is much easier to hold a comfortable temperature than it is to lower the temperature after the interior of the trailer is already hot.

AIRSTREAM INTERNATIONAL TRAILER OWNERS MANUAL

FURNACE

Manufacturer:

Hydro Flame Corporation 1874
South Pioneer Road
Salt Lake City, UT 84104
Phone: 801-972-4621

The manufacturer of the furnace in your trailer has been well known in the RV industry for many years. The furnace burns LP gas, and is powered by 12 volt current from the battery or power converter when plugged into city power. Operating instructions are located in your Owners Packet. If they should become misplaced new literature can be ordered direct from the manufacturer or your Airstream dealer. The manufacturer also offers a detailed service guide for your furnace.

If warranty service is required contact your Airstream dealer or a service location recommended by the furnace manufacturer.



WARNING: Carefully read all the manufacturer's instructions prior to operating. NEVER store flammable material next to the furnace or it's exterior vents.

AIRSTREAM INTERNATIONAL TRAILER OWNERS MANUAL

RANGE

Princess Range Top
CCD Model

Manufacturer:

Seaward Products
3721 Capitol Avenue
Whittier, CA. 90601-1732
562-699-7997

Full Oven

Manufacturer:

Magic Chef
28812 Phillips Street
Elkhart, Indiana 46514
219-264-9578

People using gas ranges in their home will find little difference in the operation of the range in a recreation vehicle. Other customers, used to electric ranges may be a little apprehensive at first; but will quickly gain confidence. The basic operation of the gas ranges have been the same for many years, but please be sure to read all the directions furnished by the manufacturer and located in the Owner's Packet. Excellent service and parts manuals are available from the manufacturer.

AIRSTREAM INTERNATIONAL TRAILER OWNERS MANUAL

REFRIGERATOR

Manufacturer:

Dometic Sales Corporation 2320
Industrial Parkway P.O. Box 490
Elkhart, Indiana 46514
Phone: 219-295-5228

Review all Dometic Literature supplied in your Owner's Packet or stored in the refrigerator prior to operating.

In an absorption refrigerant system ammonia is liquefied in the finned condenser coil at the top rear of the refrigerator. The liquid ammonia then flows into the evaporator (inside the freezer section) and is exposed to a circulating flow of hydrogen gas, which causes the ammonia to evaporate, creating a cold condition in the freezer.

The tubing in the evaporator section is specifically sloped to provide a continuous movement of liquid ammonia, flowing downward by gravity, through this section. If the refrigerator is operated out-of-level when the vehicle is not moving, liquid ammonia will accumulate in portions of the evaporator tubing. This will slow the circulation of hydrogen and ammonia gas, or in severe cases, completely block it, resulting in a loss of cooling.

Any time the vehicle is parked for several hours with the refrigerator operating the vehicle should be leveled to prevent this loss of cooling. The vehicle needs to be leveled only so it is **comfortable to live in** (no noticeable sloping of floor or walls).

When the vehicle is moving the leveling is not critical, as the rolling and pitching movement of the vehicle will pass to either side of level, keeping the liquid ammonia from accumulating in the evaporator tubing.

OPERATION

The refrigerator requires 12-volt current to operate its electronic board even if running on LP or 110-volt modes. The 12-volt is used to power the circuit board that directs the refrigerator functions. When running in a mode such as LP, it means the heat source, by far the largest power requirement; to evaporate the ammonia is being provided by an LP Gas burner.

AIRSTREAM INTERNATIONAL TRAILER OWNERS MANUAL

WATER HEATER

Manufacturer:

Atwood Mobile Products 4750
Hiawatha Drive P.O. Box 1205
Rockford, Illinois 61105
Phone: 815-877-7461

Note: Review the water heater literature supplied in your Owner's Packet before proceeding,

CAUTION: Hydrogen gas can be produced in a hot water system served by this heater that has not been used for a long period of time (generally two weeks or more). Hydrogen gas is extremely flammable. To reduce the risk of injury under these conditions, it is recommended that the hot water faucet be opened for several minutes at the kitchen sink before using any electrical appliance connected to the hot water system. If hydrogen is present there will probably be an unusual sound such as air escaping through the pipe as the water begins to flow. There should be no smoking or open flame near the faucet at the time it is open.

SAFETY

If your water system is full and cold and the water heater is ignited the system can see pressures as high as 120 psi before the relief valve starts to open. Since the water system normally operates in the 40-psi range the water expanding does put unusual stress on the system. This normally does not cause any problems, but the stress is easily alleviated. As the water is heating just open any faucet and run as little as a cup of water. Just removing this small amount of water reduces the pressure build up significantly.

For fun, watch the sequence of events your family goes through when you park the trailer **and ignite the water heater. More than likely someone will run water and relieve the pressure without even realizing it.**

AIRSTREAM INTERNATIONAL TRAILER OWNERS MANUAL

HIGH VOLUME ROOF VENT

Manufacturer:

FAN-TASTIC VENT CORP. 4349 S. Dort Hwy.
Burton, MI 48529
1-313-742-0330
1-800-521-0298

The optional High-volume roof vent system is designed to quickly exhaust stale, hot air and draw in fresh air. It's great to use when the outside temperature really doesn't call for air conditioning, but heat has built up in your coach.

OPERATING INSTRUCTIONS:

- 1) Open dome approx. 3" or more (ceiling fan has a built in safety switch that will not allow motor to operate unless dome is partially open).
- 2) Turn 3- speed knob to desired performance lever (3-Low, 2-Medium, 1-High, O-Off)
- 3) Open a window or door for airflow,
- 4) Source of airflow is determined by the window(s) or door(s) opened. For best results, close all roof vents and open 1 (one) window the greatest distance from your Fan-Tastic Vent ceiling fan,

CAUTION: Never place Lindeen™ or a like cover over ceiling fan. Greatly restricted airflow & increased sound levels will occur.

WHEN EQUIPPED WITH REVERSE SWITCH

- 1) Turn fan motor off by:
 - a) Setting 3-speed switch to "O" - OFF.
 - b) Closing Dome.
 - c) Selecting center position on IN/OUT rocker switch
- 2) Wait for fan blade to stop.
- 3) Select IN position brings air from the roof area into your coach (pressurizes inside).
- 4) Or select OUT position, brings air in through any or all openings in coach and exhausts through the roof.
- 5) Turn fan motor On.

WHEN EQUIPPED WITH THERMOSTAT:

- 1) Follow "Operating Instructions: 1 thru 4
- 2) Select desired temperature or comfort level on thermostat. Fan motor will now start & stop automatically as interior temperature of coach exceeds or drops below selected level.

NOTE: Fan motor will not start if temperature selected is warmer than interior temperature of coach.

CLEANING INSTRUCTIONS:

- 1) Turn fan motor Off.
- 2) Remove 8 painted flathead Phillips screws around perimeter of screen insert only.
- 3) Clean screen with soap & water solution and reinstall.

AIRSTREAM INTERNATIONAL TRAILER OWNERS MANUAL

HIGH VOLUME ROOF VENT

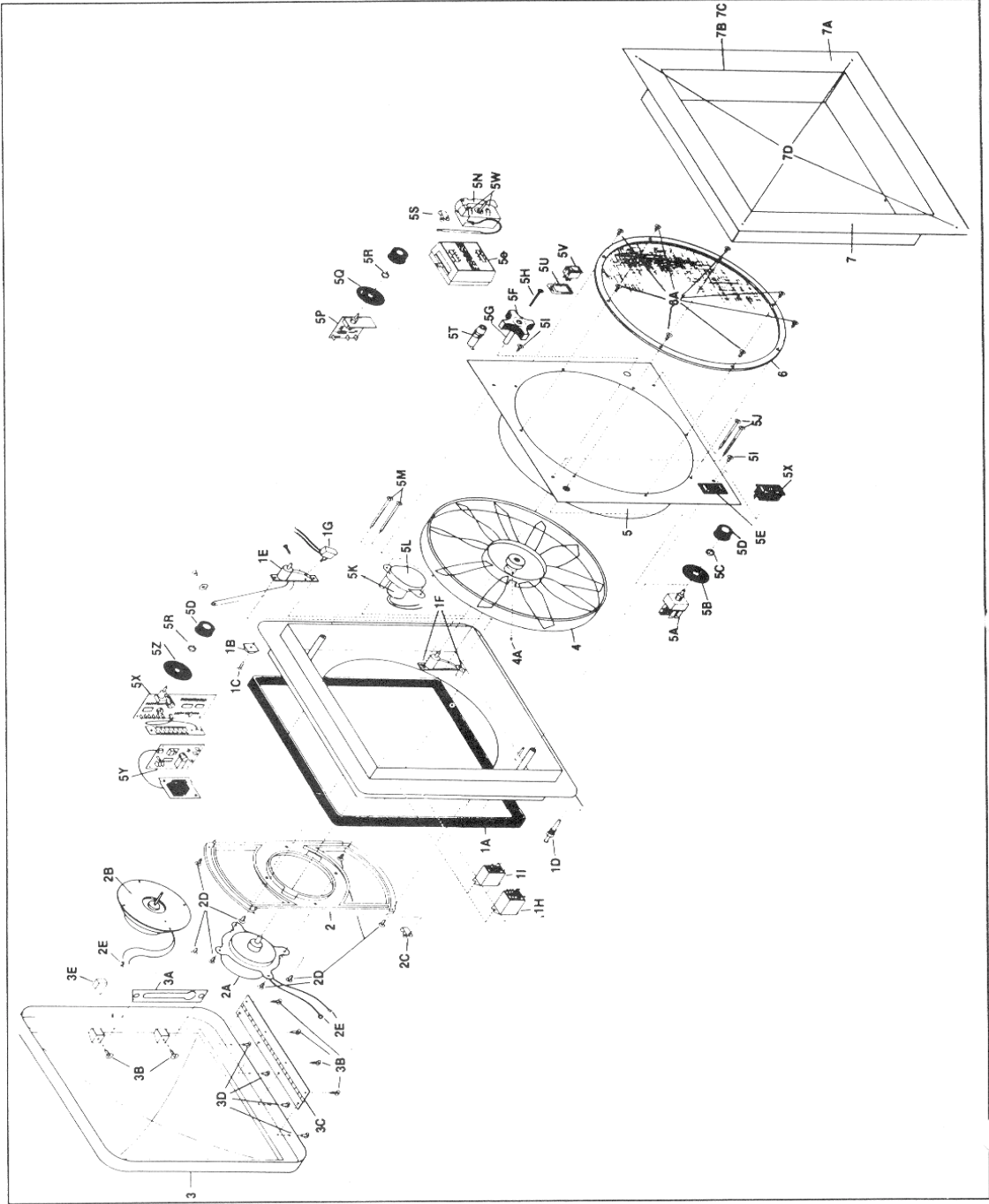

AIRSTREAM INTERNATIONAL TRAILER OWNERS MANUAL

HIGH VOLUME ROOF VENT

Parts List

#1	#1010-81 MAIN BASE
(4.5)	#1 #1144-09 EPDM BULB SEAL
	#IB #1024-81 ALIGNMENT SPACER
	#IC #1025-05 #8 x 5/8 F.H. PH. t/s ZINC
	#ID #1122-05 JAMB SWITCH #9251 - C.H.
	#IE #2011-05 6" LIFT ARM -w/RIV. & BUSHING
(2)	#IF #1012-05 #10 x 1/2" P.H. PH. p/s - ZINC
(2)	#IG #2053-09 P-267T-IA-RD CARLING LIMIT
	#IH #2052-00 LYZF - DC - 12 - OMRON
	#11 #9002-09 G4W -1 1123 - 95 - TVB - DC - 12 OMRON
#2	#1015-00 "H" MOTOR MOUNT
#2A	#4017-09 MOTOR - PM3491x - BLK - 1600 RPM
#2B	#1017-03 MOTOR-#31153-140ORPM-CSA
#2C	#1019-81 HEYCO - CCL 1/8 - #3302 CLAMP
(8)	#2D #1016-05 #8 x 1/2 P.H. PH. t/s -ZINC
#2E	#1121-05 B3R - 56 - RING CONNECTOR
	#3 #1020-19 DOME-SMOKE
#3A	#1023-05 DOME SLIDE - GALVANIZED
(6)	#3B #1016-05 #8 x 1/2 P.H. PH. t/s - ZINC
#3C	#1021-05 #1260A - HINGE - ALUMINUM
#3D	#1022-05 5/32 x 1/4 x 5/16 "o" RIVET ZINC
#3E	#2018-81 DOME WEDGE - WHITE NYLON
#4	#1138-00 FAN BLADE - 12" CLR.
#4A	FAN BLADE SET SCREW
#5	#1030- SCREEN ASSEMBLY COLORED
#5A	#1031-05 3-SPEED SWITCH #3K754
#5B	#1033-09 DIAL LABEL - BLK. POLY
#5C	#1032-05 NUT - 7/16 x 28 UNEF - ZINC
#5D	#1034-09 KNOB - SOFT TOUCH #PT-6-P
#5E	#9001-09 DPDT - HOT STAMPED w/CROSS KNOB
#5F	#1140-09 1741Z - BLACK
#5G	#2143-05 EXTENSION 1 1/8 - ZINC
#5H	#1142-05 8-32 x 1 3/4 P.H. PH. m/s ZINC
(2)	#51 #1038-#88 x 3/8" F.H. PH t/s - COLOR
(2)	#5J #1039-#8 x 2 3/4" F.H. PH. w/s - COLOR
#5K	#6050-05 DOME LIFT MOTOR - #200.0262A
#5L	#6035-MOTOR CAP - COLORED
(2)	#5M #1039-#8 x 2 3/4 F.1-1. PH. w/s - COLOR
#5N	#9006-05 BT THERMO #3301B
#5P	#9015-90 SST THERMO #00-00127-000
#5Q	#9009-09 LABEL-COOLER-BLACK
#5R	#1032-05 NUT - 7/16 x 28 UNEF- ZINC
#5S	#1018-81 BT CLAMP - CCL 1/4 - #3304
#5T	#9017-00 FUSE #312010 - 10A - FLTW*
#5T	#9018-09 FUSE HOLDER #345602 - FLTW*
#5U	LABEL OVERRIDE/NORMAL
#5V	B-2-1 8 GOLD - SPST-SGMA
(2)	#5W #9008-05 6 - 32 x 1/4 F. H. PH. m/s - ZINC
#5X	SPSTw/ON/OFF LABEL
#5e-	#9005-39 RBT. SHW w/OFF WALL THERMO
#6	#1035-SCREEN RING w/ALUM. WIRE - COLOR
(8)	#6A #1038-8B x 3/8" F.H. PH. t/s -COLORED
#7	#1040-INTERIOR GARNISH - 3" MAX. - COLOR
#7A	#9024-81 INTERIOR GARNISH - 4" MAX. - COLOR
#7B	#9019-00 OAK STYLE - FINISHED
#7C	#9020-00 OAK RETURN PANEL - ANY SIZE
#7D	#9010-#6 x 3/4 F.H. PH. t/s - COLORED

AIRSTREAM INTERNATIONAL TRAILER OWNERS MANUAL

NOTES

AIRSTREAM INTERNATIONAL TRAILER OWNERS MANUAL

SPECIFICATIONS

Note: All weights were made on prototype vehicles. Your production trailer may vary. For the weight specifications of your trailer read the weight label (see location information under "Loading" section of this manual) and check the manufacturing tag on the side of your trailer.

MODEL	22' AS	22' CCD
Exterior Length	22' 4"	22' 4"
Exterior Width	8'	8'
Interior Width	7' 7"	7' 7"
Exterior Height W / AC	9' 4"	9' 4"
Exterior Height W/O AC	8' 8"	8' 8"
Interior Height W/AC	6' 4 1/2"	6' 4 1/2"
Interior Height W/O AC	6' 7"	6' 7"
*Hitch Ball Height	18 "	18 "
**Hitch Wt. (lbs.)	600	590
GVWR (lbs.)	5,000	5,000
CCC (lbs.) w/o options	360	511
UVW (lbs.)	4,240	4,043
LPG (lbs.) 2 Bottles	20 ea.	20 ea.
Tire Size (LRC)	ST 215/75R14	ST 215/75R14
Fresh water (gal.)	30	30
Gray water (gal.)	21	21
Black water (gal.)	21	21

Gross Vehicular Weight Rating (GVWR): is the maximum permissible weight of the motorhome when fully. It includes all weight at all vehicle axles.

Unloaded Vehicle Weight (UVW) of a motorhome is the weight of a motorhome as manufactured at the factory. It includes all weight at the axles with full generator fluids, including fuel, engine oil, and coolants.

Cargo Carrying Capacity (CCC) is equal to GVWR minus each of the following: UVW, full fresh (potable) water weight (including water heater), and full LP-Gas weight.

Gross Axle Weight Rating (GAWR): is the value specified as the load carrying capacity of a single axle system, as measured at the tire-ground interfaces.

GAWR (Gross Axle Weight rating are located on the manufacturing tag that is positioned on the roadside side sheet of your travel trailer.

*Hitch Ball Height

The proper height will vary according to the weight you carry and the tires you use. However, checking the height on your trailer is relatively easy:

1. With trailer on fairly level ground measure from ground to bottom of frame, front and rear.
2. Adjust front jack until measurements are equal
3. Now measure from ground to the inside top of ball coupler. This figure is the hitch height. The hitch ball is then usually set 1/2" to 1" higher, according to the spring weight of your tow vehicle, to allow for it to settle when the trailer is hitched up.

** Without options or variable weight.