

2001 XC 360 DIESEL PUSHER

Table of Contents

SECTION I A through C

Appliances

Air conditioner	I-1
Furnace	I-1
Microwave	I-1
Range	I-2
Refrigerator	I-2
Water heater	I-3

Body

CS wall	I-4
RS wall	I-6
Slide out extrusion	I-8
Slide out gaskets	I-9
Front end	I-10
Aft end	I-12
Roof	I-14

Chassis

Hitch	I-15
Power Jacks	I-15
Step	I-15
Exhaust extension	I-15
Automotive air conditioner	I-16

2001 360 XC DIESEL PUSHER
TABLE OF CONTENTS

SECTION II
D through E

Dash

[Dash parts](#) II-1
[Dash Instrument Panel](#)..... II-2

[Decals \(reference\)](#)..... II-3

Doors/Windows/Awnings

[RS wall](#) II-4
[CS wall](#) II-6
[Main and screen door](#)..... II-8
[Awnings](#)..... II-10

[Drapes/Blinds/Valances](#)..... II-11

Electrical

[110 Volt](#)..... II-12
[12 Volt chassis](#)..... II-14
[Driver-passenger armrest, center console, switches](#) II-16
[12 volt dash](#) II-17
[12 Volt interior switches](#)..... II-17
[12 Volt interior lights](#) II-18
[12 Volt exterior lights](#) II-19
[12 Volt Misc. equipment](#) II-20
[Battery compartment](#)..... II-21
[Windshield wiper](#)..... II-22

Entertainment

[Televisions](#) II-24
[Radio](#) II-24
[Antennas](#) II-24
[CD changer](#) II-24
[Rear view monitor](#) II-25

2001 XC 360 DIESEL PUSHER

Table of Contents

SECTION III

F through H

FASTENERS

Rivets	III-1
Screws	III-3

FLOOR COVERING

Carpet	III-4
Tile	III-4
Floor mats	III-4

FURNITURE

Interior & Misc. doors	III-5
Mirrors	III-6
Drawer faces & boxes	III-7
Bed room	III-8
Bath	III-9
Galley	III-10
Lounge	III-12
Cab	III-13

HARDWARE

Exterior, main & screen door	III-14
Exterior compartments	III-17
Slide out	III-18
Awning	III-21
Interior	III-22
Window	III-26

2001 360 XC DIESEL PUSHER
TABLE OF CONTENTS
SECTION IV
L through Z

LABELS and TAGS	IV-1
OPTIONS	IV-3
PLUMBING	
LPG	IV-5
Fresh water	IV-6
Includes: Tank, fittings, and faucets	
Drain	IV-12
Includes: Tanks, fittings, and toilet	
SAFETY EQUIPMENT	IV-17
SEALS/SEALER/GASKETS	
Gaskets	IV-18
Window gaskets	IV-19
Sealer	IV-20
Adhesives, paint, under coat, stain	IV-21
UPHOLSTERY/FOAM/MATTRESS	
Mattress	IV-22
Sofa	IV-22
Chair	IV-22
Bed spread	IV-22
Pillow kits	IV-23
Dinette seat	IV-26
VENTS/FANS/SKY LIGHTS	IV-27
WOOD/INTERIOR TRIM	IV-28

Table of Contents

SECTION I A through C

Appliances

Air conditioner	I-1
Furnace	I-1
Microwave.....	I-1
Range.....	I-2
Refrigerator.....	I-2
Water heater	I-3

Body

CS wall	I-4
RS wall	I-6
Slide out extrusion	I-8
Slide out gaskets.....	I-9
Front end	I-10
Aft end	I-12
Roof	I-14

Chassis

Hitch	I-15
Power Jacks.....	I-15
Step	I-15
Exhaust extension	I-15
Automotive air conditioner	I-16

2001 360XC DIESEL PUSHER

APPLIANCES

DUO THERM AIR CONDITIONER-PENQUIN

690323-33	Air conditioner, Penquin 13,500 BTU
690323-34	Electronic kit, Penquin
690323-31	Thermostat, Duo Therm
690323-100	Shroud, exterior, Penquin
385582-01	Decal, Airstream w/bar, gray
203069	Register, white, 4" x 8"
690323-12	Cover, return grill

FURNACE, HYDROFLAME (800-825-4328)-dealer only

690274	Furnace, Hydroflame, #8535-IV, 34,000 BTU
690244-06	Mounting flange
690274-06	Door exterior, Hydroflame
601244-03	Register, rotaire, black
600969-01	Grille, 6"x4", col. white
600247	4" duct hose, flexible
601244-02	Register, rotaire, 4", white

MICROWAVE

690368-01	Microwave/convection oven, Sharp
-----------	----------------------------------

2001 360XC DIESEL PUSHER

APPLIANCES

RANGE

690396-06 Range top, 3 burners, Magic Chef
690396-03 Range cover, bi-fold
964383-01 Range covers, Corian, set

DOMETIC REFRIGERATOR, RM 3862R (800-366-3842)

690370-01 Refrigerator, 2-way, RH, RM 3862R
801225-014 Door panel, upper, oak, 15.5" x 20.38"
801225-034 Door panel, lower, oak, 38.38" x 20.38"
690370-100 Cooling unit, RM 3862
381207-03 Vent, roof, Dometic, polar white
690340-03 Refrigerator door, exterior

2001 360XC DIESEL PUSHER

ATWOOD WATER HEATER

690417-01	Water heater, 10 gal. elec. ignition, 110 volt/gas
690259-05	Access cover, white
690259-06	Mounting flange, white, 10gal.
500933	Switch, water heater, electronic

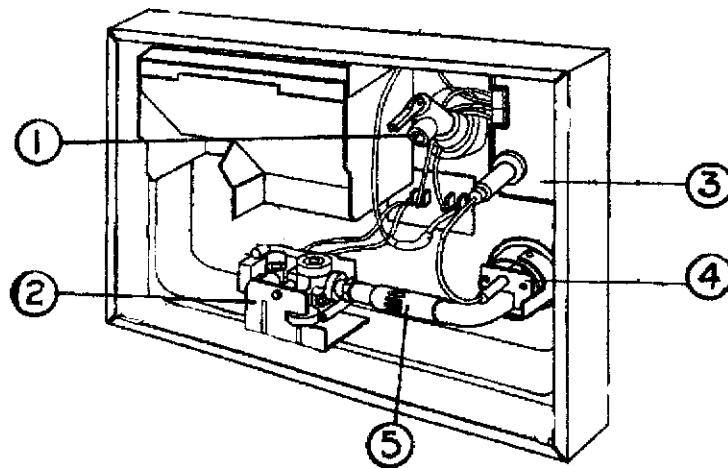

Front of water heater

1) 091604	Relief valve, pressure/temperature
2) 093870	Solenoid valve
3) 093865	Circuit board
4) 093868	Spark probe
5) 093221	Main burner, 10 gallon

Back of water heater

091160	Heating element, 110volt
091873	ECO thermostat
091092	On/off switch, 110Volt

2001 360XC DIESEL PUSHER

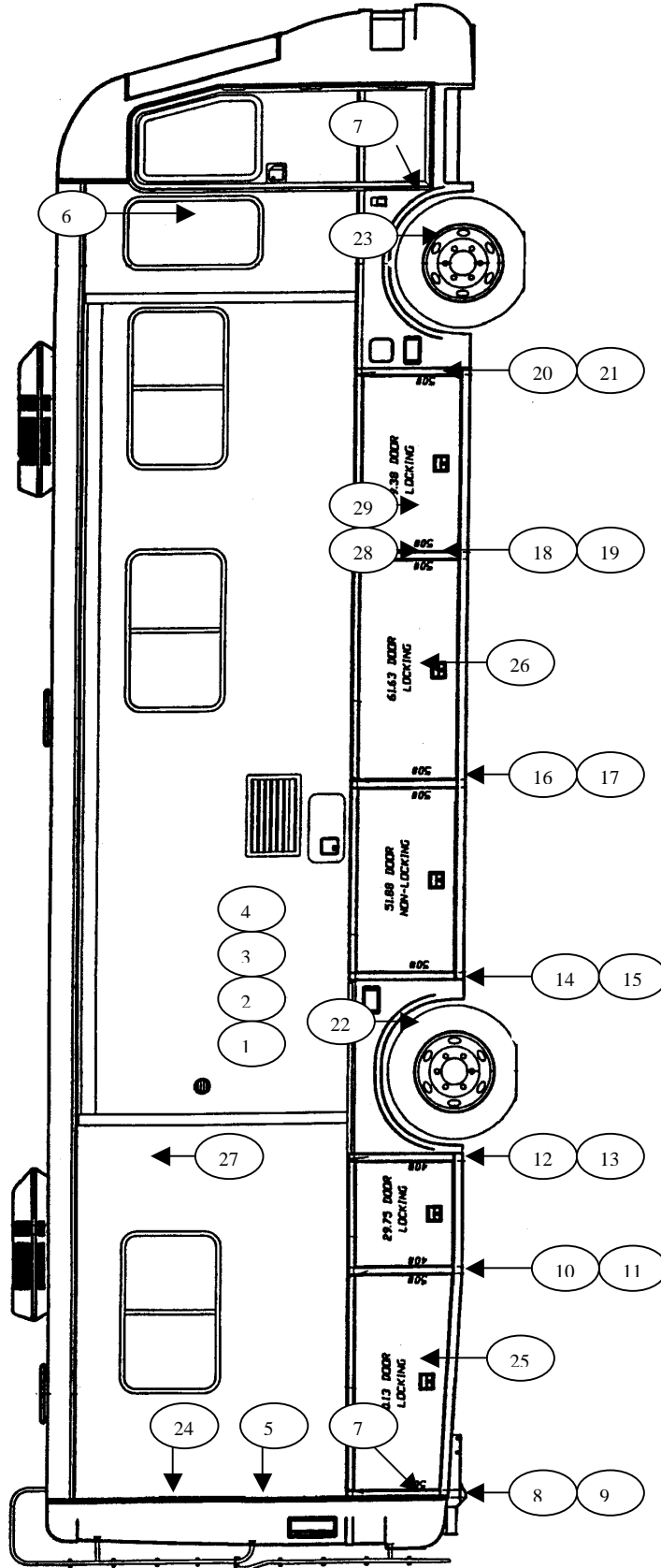

2001 360XC DIESEL PUSHER

CURBSIDE WALL

1) 801002-17	Fiberglass sheet, white, 77.5" x 408"
2) 915568	Weldment, CS wall
3) 203075	Styrofoam sheet, 1 ½" thick
4) 801261-01	Paneling, interior, 1/8" x 4' x 7', G1S, Ant. Buff
5) 114005-02	Extrusion, trim, cap to sidewall, white
6) 114808-04	Drip cap, cab window, CS
7) 385983-01	End cap casting, white
8) 115015-02	Panel, skirt, CS rear angled
9) 115021-02	Panel, skirt back, flange CS, 24.31"
10) 115016	Panel, skirt DBL. flange, 29.94"
11) 115017	Panel, skirt back, 27.50
12) 115011	Panel, skirt, LH flange, 29.25"
13) 115019-01	Panel, skirt back flange, 27.50"
14) 115012	Panel, skirt RH flange, 29.94"
15) 115019-02	Panel, skirt back, RH flange, 27.50"
16) 115016	Panel, skirt DBL. flange, 29.94"
17) 115017	Panel, skirt back, 27.50"
18) 115016	Panel, skirt DBL. flange, 29.94"
19) 115017	Panel, skirt back, 27.50"
20) 115011	Panel, skirt, LH flange, 29.25"
21) 115019-01	Panel, skirt back flange, 27.50"
22) 203259	Fender, CS rear
23) 203260	Fender, CS front
24) 320124-06	Screw, #6x1", CS head, stainless, white
25) 114836-01	Rocker panel, Angled, CS rear
26) 114708-01	Rocker panel, straight
27) 114570	Awning rail
28) 114831	Extrusion, rub-rail carrier
29) 203080-01	Molding, rub-rail, white

Not shown

386067-03	Medallion, 70th anniversary, 4.3/8"
114070-02	J-trim, compartment skirt to plastic fender

2001 360XC DIESEL PUSHER

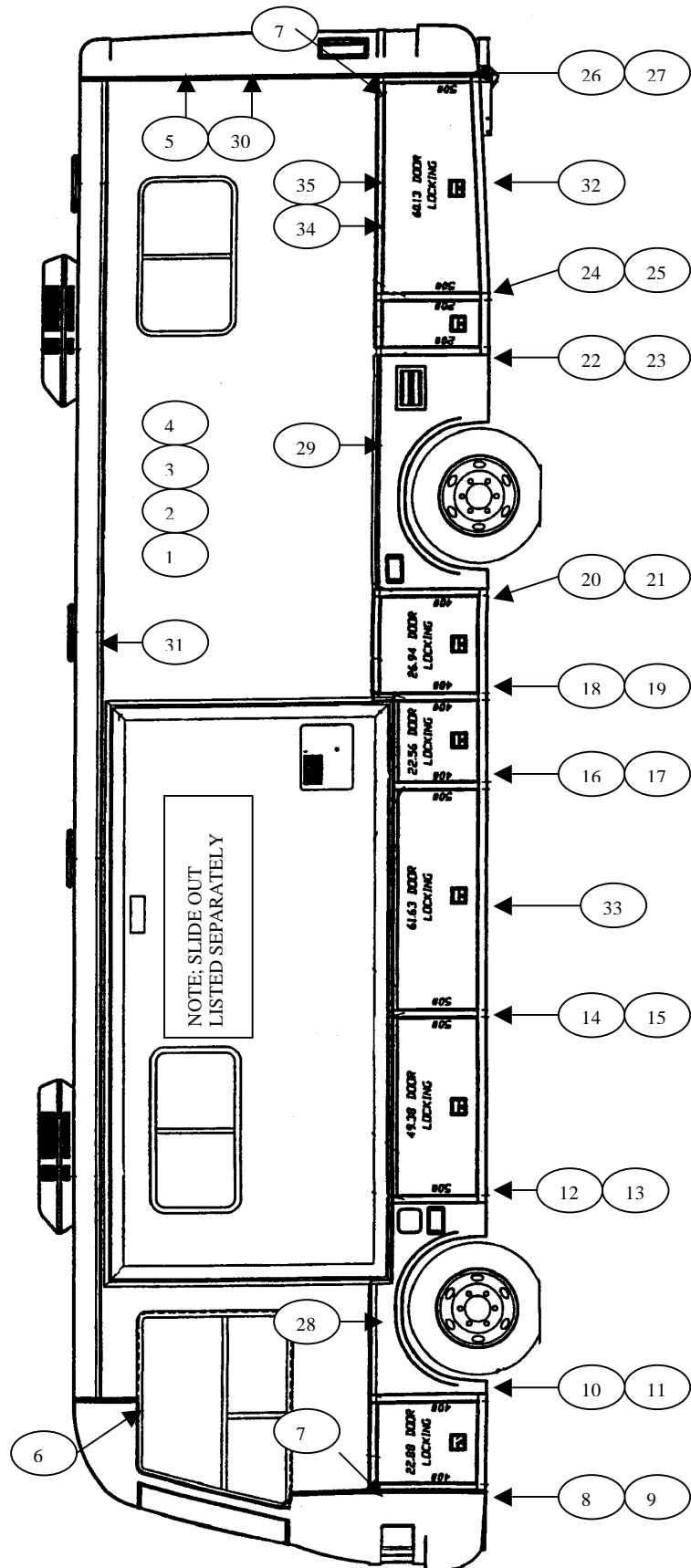

2001 360XC DIESEL PUSHER

ROADSIDE WALL

Note: slide-out on separate page

- | | |
|---------------|---|
| 1) 801002-07 | Fiberglass sheet, white, 77.5"x408" |
| 2) 203075 | Styrofoam sheet, 1 ½" thick |
| 3) 915569 | Weldment, RS wall |
| 4) 801261-01 | Paneling, interior 1/8" x 4' x 7' G1S, Anti. Buff |
| 5) 114005-02 | Extrusion, trim, end cap to sidewall, white |
| 6) 114808-03 | Drip cap, cab window, RS |
| 7) 385983-01 | End cap casting, rub-rail, white |
| 8) 115012 | Panel, skirt, RH flange, 29.94" |
| 9) 115019-02 | Panel, skirt back, RH flange, 27.50" |
| 10) 115011 | Panel, skirt LH flange, 29.25" |
| 11) 115019-01 | Skirt back, LH flange, 27.50" |
| 12) 115014 | Panel, skirt slide, RH flange, 24.44" |
| 13) 115020 | Panel, skirt back, flange slide, 22.25" |
| 14) 115013 | Panel, slide DBL. flange, 24.44" |
| 15) 115018 | Panel, skirt back slide, 22.50" |
| 16) 115013 | Panel, slide DBL. flange, 24.44" |
| 17) 115018 | Panel, skirt back slide, 22.50" |
| 18) 115016 | Panel, skirt DBL. flange, 29.94" |
| 19) 115017 | Panel, skirt back, 27.50" |
| 20) 115011 | Panel, skirt LH flange, 29.25" |
| 21) 115019-01 | Skirt back, LH flange, 27.50" |
| 22) 115012 | Panel, skirt, RH flange, 29.94" |
| 23) 115019-02 | Panel, skirt back, RH flange, 27.50" |
| 24) 115016 | Panel, skirt DBL. flange, 29.94" |
| 25) 115017 | Panel, skirt back, 27.50" |
| 26) 115015-01 | Panel, skirt angled rear RS |
| 27) 115021-01 | Panel, skirt back flange RS angled 24.31" |
| 28) 203262 | Fender RS front |
| 29) 203261 | Fender, RS rear |
| 30) 320125-06 | Screw, #6x1", CS head, stainless white |
| 31) 114570 | Awning rail |
| 32) 114836-01 | Rocker panel, angled RS rear |
| 33) 114708-01 | Rocker panel, straight |
| 34) 203080-01 | Molding, rub-rail, white |
| 35) 114831 | Extrusion, rub-rail carrier |

2001 360XC DIESEL PUSHER

SLIDE OUT EXTRUSION

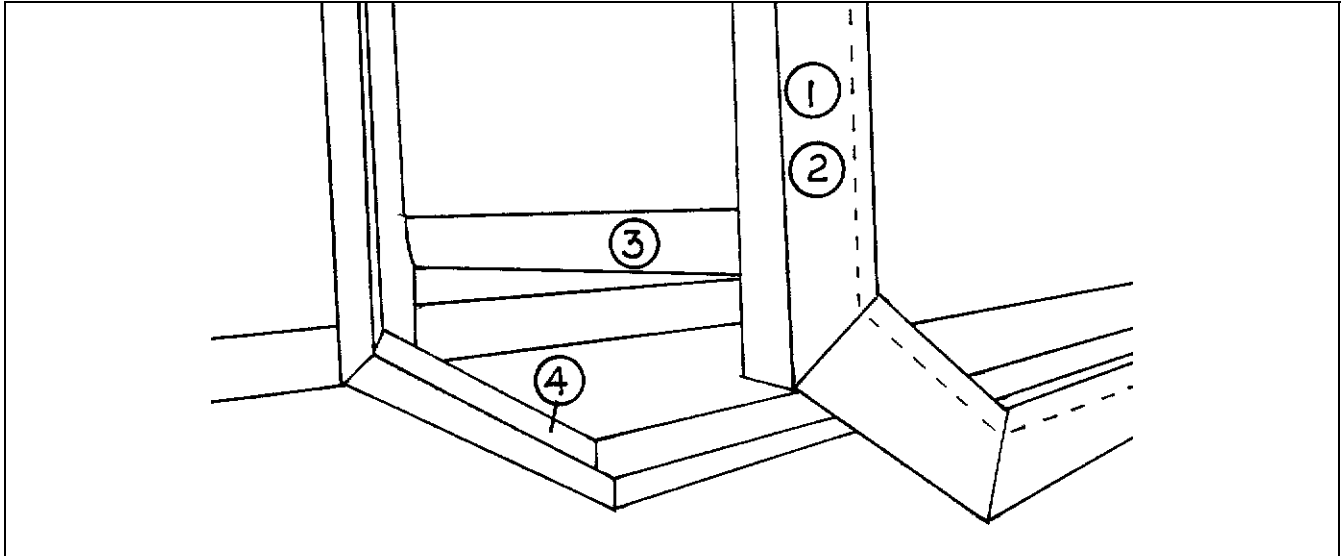

Lower front corner, extended

*1) 114771

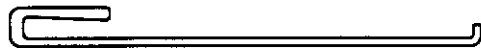

Extrusion, slide out trim

2)

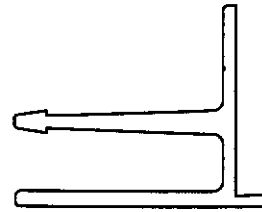

114770 Extrusion, slide out box (fits behind 1)

3)

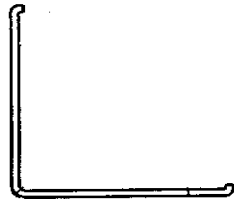

114768 Extrusion, slide out corner trim

4)

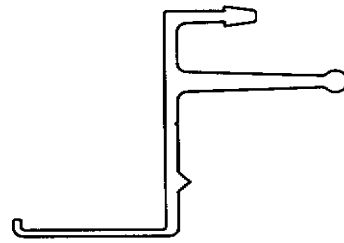

114726 Extrusion, slide out frame

*This trim is slotted to allow adjustment to the sidewall cutout. Fitting will be required.

2001 360XC DIESEL PUSHER

* SLIDE OUT GASKETS

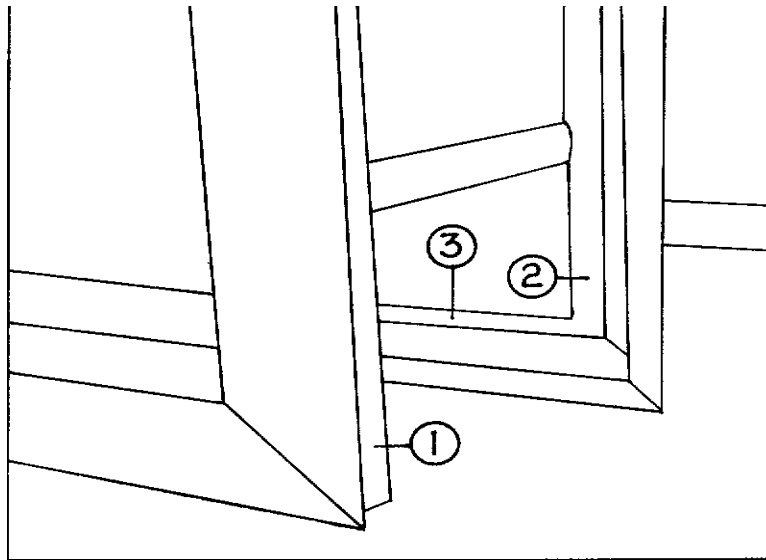

Lower rear corner, extended

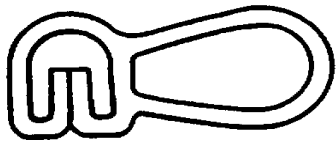

- 1) 381594 Rubber extrusion
Bulb type, black

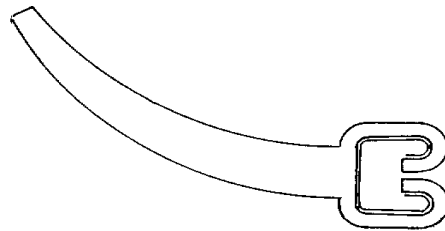

- 2) 381587 rubber extrusion, wiper

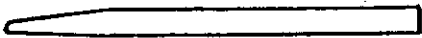

- 3) 381589 Rubber extrusion
floor wiper



- 381663 (not shown)
Rubber extrusion, bulb
w/tape-used on inside
wall

*Note: Mounting brackets can be found in hardware.

2001 360XC DIESEL PUSHER

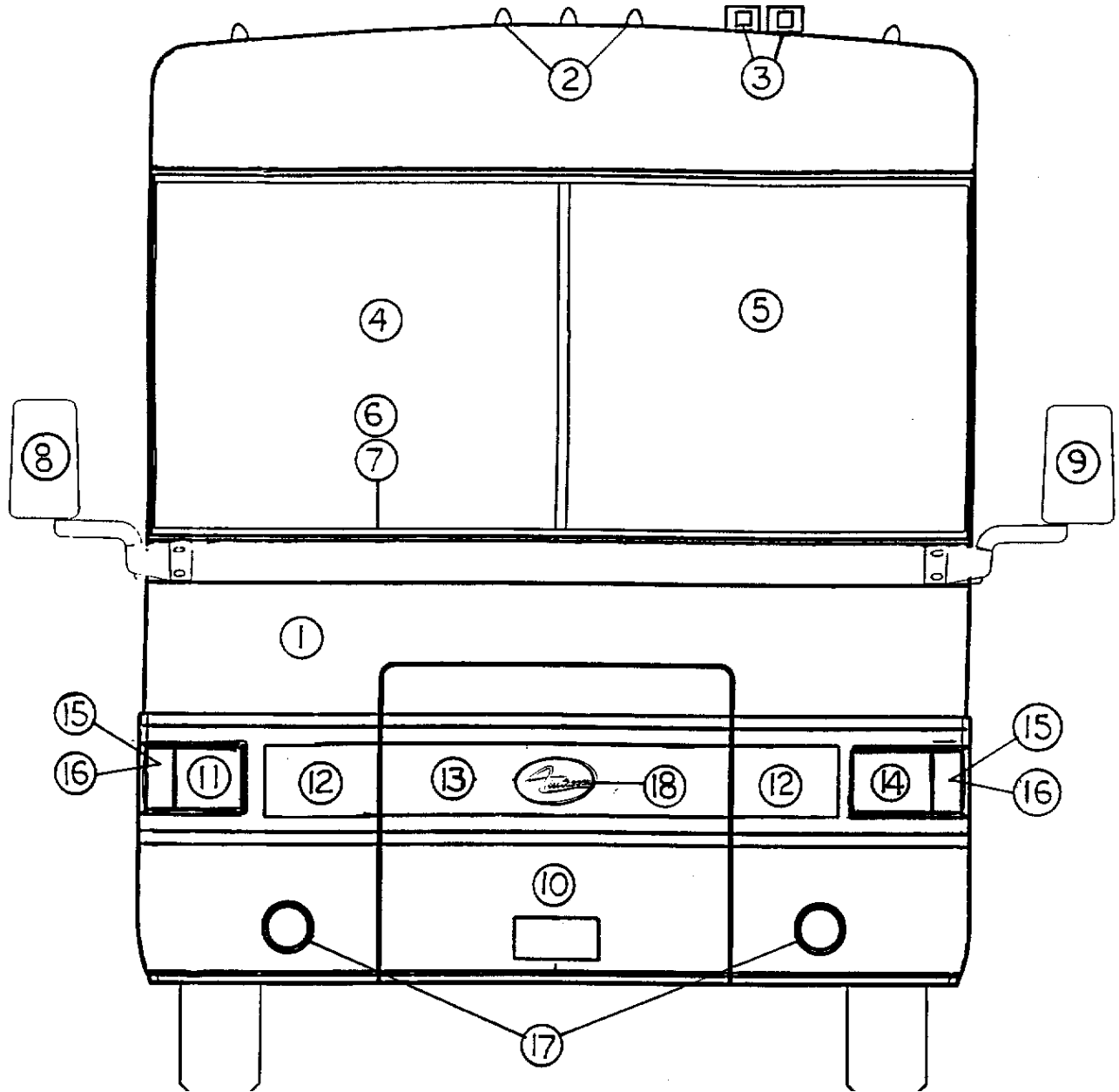

2001 360XC DIESEL PUSHER

FRONT

- | | |
|---------------|---|
| 1) 203255 | Nose, XC 360 diesel |
| 2) 511400-02 | Light, marker, teardrop |
| 3) 510804 | Horn, air, chrome |
| 4) 371339 | Windshield, CS |
| 5) 371338 | Windshield, RS |
| 6) 381524 | Gasket, windshield (one piece for both sides) |
| 7) 201260 | Insert rubber, windshield gaskets |
| 8) 511512-02 | Mirror, CS, remote, heated, black |
| 9) 511512-01 | Mirror, RS, remote, heated, black |
| 10) 203256 | Door, generator |
| 11) 511550-01 | Head light assembly, CS |
| 12) 453828-01 | Panel nose, SS, side panel |
| 13) 453828-02 | Panel nose, SS, center |
| 14) 511550-02 | Head light assembly, RS |
| 15) 511562-01 | Socket, park/turn light |
| 16) 511562-02 | Bulb, dual filament, park/turn light |
| 17) 511514 | Auxiliary head light kit |
| 18) 386043-03 | Medallion, Airstream, black |

2001 360XC DIESEL PUSHER

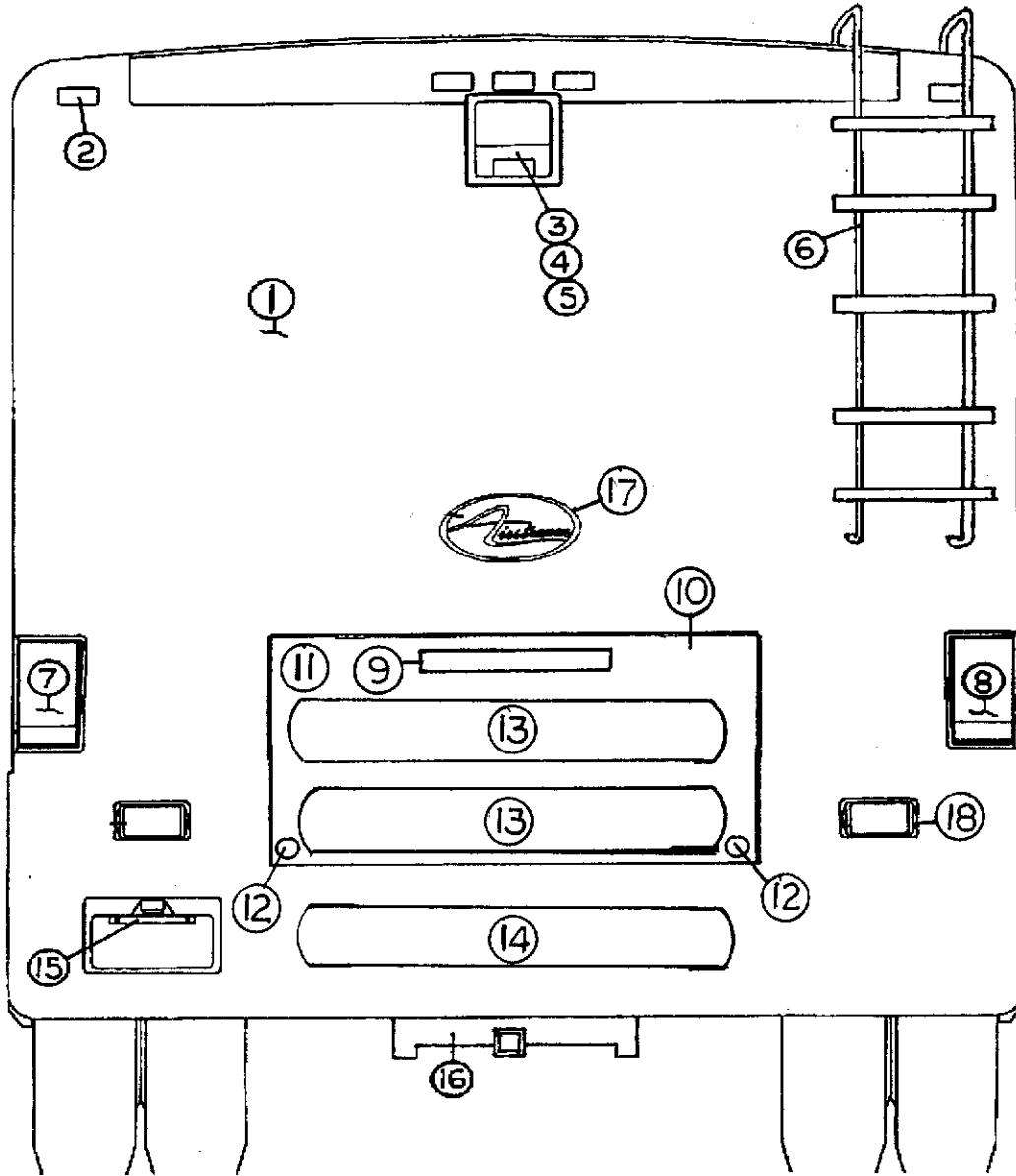

2001 360XC DIESEL PUSHER

AFT END

- | | |
|---------------|--|
| 1) 203257 | Rear Cap, Diesel Pusher |
| 2) 510984-01 | Clearance light, red |
| 3) 510918-01 | Monitor, Sony Watchman |
| 4) 203181 | Cover, Back-up camera |
| 5) 511044-03 | Actuator, Two position, push/pull |
| 6) 381639-01 | Ladder, rear cap, 2pc, (bottom not shown) |
| 7) 511589-01 | Tail lamp, L.H., Assy, w/bulbs & sockets |
| 8) 511589-02 | Tail lamp, R.H., Assy., w/bulbs & sockets |
| a) 511584 | Socket, turn signal, Ford |
| b) 511585 | Socket, Stop/tail light, Ford |
| c) 511586 | Socket, Back-up light, Ford |
| d) 511587 | Bulb, 3357, stop/tail |
| e) 511588 | Bulb, 3156, turn/back-up |
| f) 511589 | Taillight assy, Ford w/o sockets and bulbs |
| 9) 511154-02 | Light strip, 3rd brake light, 10" x 1" |
| 10) NPN | Rear engine door assy. |
| 11) 203258 | Rear engine door, Fiberglass only |
| 12) 381227-01 | Latch, vise action, engine door |
| 13) 453820-04 | Screen, rear cap, Door, 18.50" x 47" |
| 14) 453820-03 | Screen, rear cap, Bumper, 10" x 47" |
| 15) 511407 | License plate light w/holder |
| 16) 400868 | Hitch, Reese XL 360 |
| 17) 386043-03 | Medallion, Airstream, Black |
| 18) 511101-01 | Docking light, S.S. |

Not shown

- | | |
|-----------|---------------------------------------|
| 381396 | Gasket, clearance light, neoprene |
| 511361 | Light, courtesy, flush-mount, Black |
| 381434 | Hinge, S.S., 3"x8', door |
| 385587 | Bumper, adjustable, rubber, rear door |
| 381310 | Gas prop, door |
| 381569-05 | 17" spring, 17 lbs., door |

2001 360XC DIESEL PUSHER

ROOF

203024	Fiberglass sheet, roof exterior, 106"wide
114568	Extrusion, roof corner cap
114570	Extrusion, awning rail
702482	Ceiling liner, Spectra Opal
800507-01	Paneling, luan, ceiling liner backing
201728-01	Extrusion, ceiling trim retainer
201728-03	Extrusion, ceiling trim
203069	Registers, ceiling vents

2001 360XC DIESEL PUSHER

CHASSIS

410830	Reese hitch, Land Yacht XC
453547	Bracket, L.P. tank
961001	Step assembly, roof ladder KWIKEE STEP
511577	Switch body W/rocker switches, 3-gang, by door
511578	Switch cover, 3 gang, printed
511484	Step, electric, double, Kwikiee #904006
511486	Switch, magnetic, round, in doorjamb
511022-100	Motor, double step
511022-101	Control box, main, Kwikiee #909508
511022-100	Motor, double step
203133	Step trim, plastic
451811	Extender, tire valve
203280	Mud flap, behind rear wheels
203281	Mud flap, in front of rear wheels
203280-01	Mud flap, behind front wheels
203282	Mud flap, forward of front wheels
410829	Exhaust extension 5" x 18", chrome
410773	Hose, fuel fill, 2" I.D.

2001 360XC DIESEL PUSHER

CHASSIS

DASH A/C

Acme

(800-552-2263)

690382-01	Heater, air conditioner evaporator
690356	Kit heater/ac accessory, Freightliner
690355	Condenser tri-pack
511112	Pump, vacuum #4570568
600214-03	Heater hose, 5/8"
601556	Hose, AC #6 5/16
601557	Hose, AC #8 13/32
601558	Hose, AC #12 5/8
690382-07	Plenum kit, short, w/Acme rotary control
453740	Bracket, condenser mtg.
453515	Angle, condenser mtg.
690356-100	Dryer, Acme air conditioner, Freightliner
690356-101	Resistor, blower speed control
511452	Fuse holder, ATC, weather proof, blower motor

POWER GEAR LEVELING JACK SYSTEM

410825-04 Semi-automatic

500584 (Vendor P/N complete kit)

800-334-4712 For warranty or retail parts replacement

VENDOR #	DESCRIPTION
500082	9000LB LEG, 22.5, 15, 17.38, 10 (2)
500070	16,000LB LEG, 3 16 20 10 WD LS (2)
500091	KIT, LEG MOUNTING (4)
500507	POWER UNIT ASS'Y
5014-342	HARNESS, PUMP, 342"
5018-280	HARNESS, COACH INTERCONNECT(280")
5017-351	HARNESS, 'B' SYSTEM T.P. TO C.B.
500536	CONTROL BOX 'B'
500535	TOUCH PAD, SYS. 'B'
81-1310	VIDEO, AIRSTREAM - 4 JACK
82-L0100-00	MANUAL, SEMI-AUTO LEVELING
07-1059	FITTING, LEG, 90° (4)
08-A031	31' HOSE (RS REAR)
08-A092	92' HOSE (CS REAR)
08-A264	264' HOSE (RS FRT)
08-A287	287' HOSE (CS FRT)

2001 360XC DIESEL PUSHER

SECTION II D through E

Dash	
Dash parts.....	II-1
Dash Instrument Panel.....	II-2
Decals (reference)	II-3
Doors/Windows/Awnings	
RS wall	II-4
CS wall	II-6
Main and screen door	II-8
Awnings	II-10
Drapes/Blinds/Valances	II-11
Electrical	
110 Volt	II-12
12 Volt chassis	II-14
Driver-passenger armrest, center console, switches.....	II-16
12 volt dash	II-17
12 Volt interior switches	II-17
12 Volt interior lights	II-18
12 Volt exterior lights.....	II-19
12 Volt Misc. equipment	II-20
Battery compartment	II-21
Windshield wiper	II-22
Entertainment	
Televisions	II-24
Radio.....	II-24
Antennas.....	II-24
CD changer	II-24
Rear view monitor	II-25

2001 360XC DIESEL PUSHER

DASH

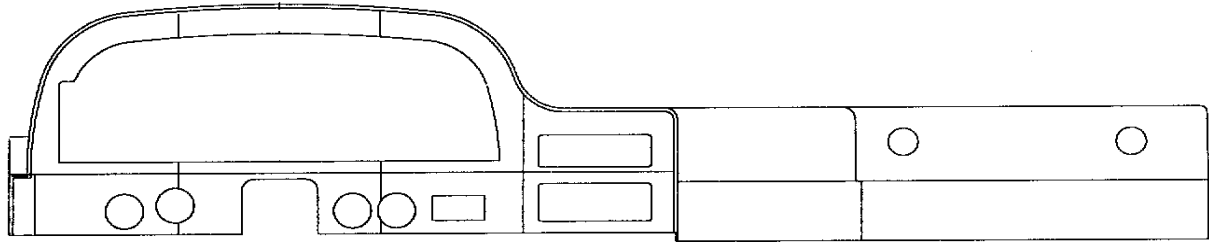

203268 Dash base, fiberglass

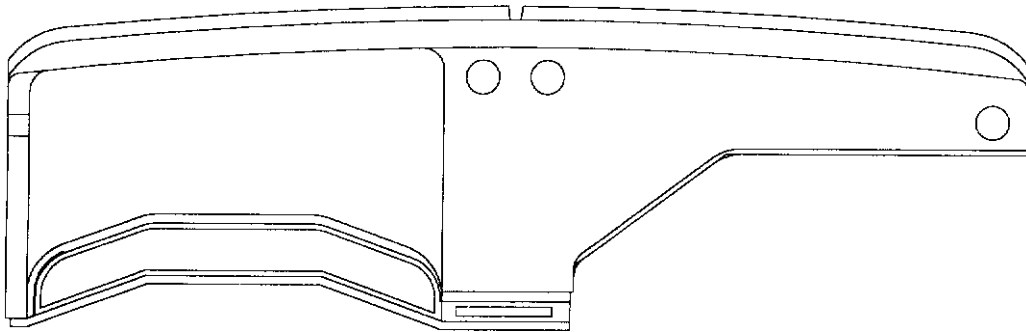

203269 Dash, vinyl wrapped

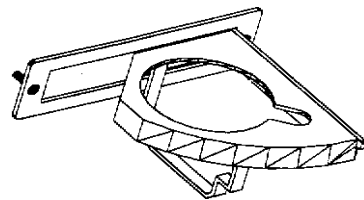
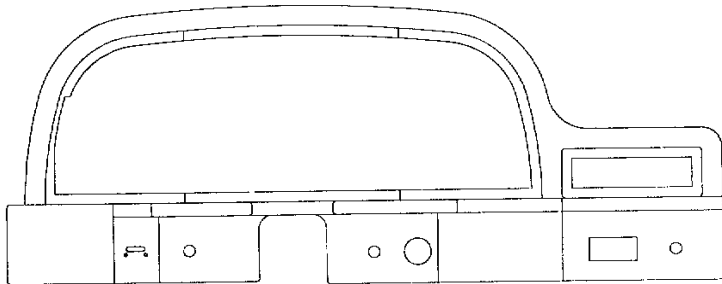

203248 Trim ring, instrument panel, vinyl

203234 Pop out cup holder

Not shown
386064-03 Medallion, black, 3"

2001 360XC DIESEL PUSHER

DASH INSTRUMENT PANEL

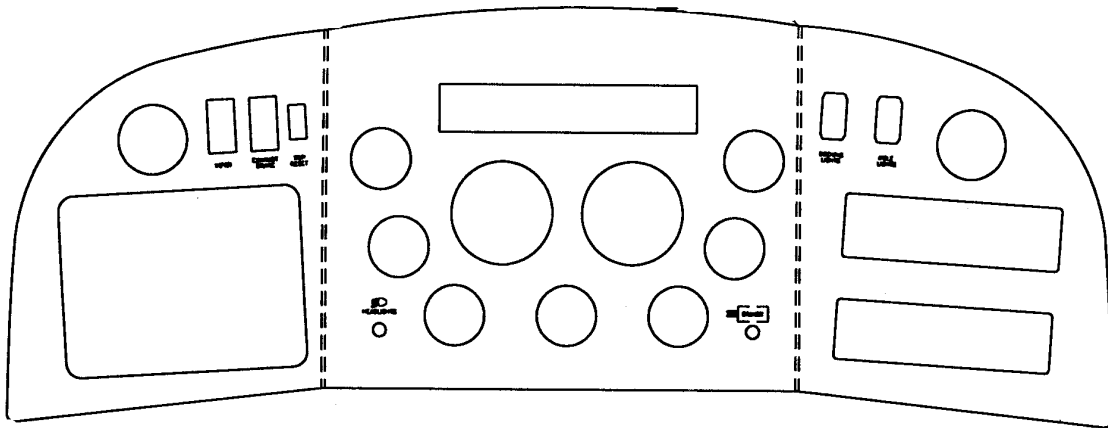

511575

Includes Docking & Aisle Switches only

511579-101	Switch, Docking & Aisle
511419-06	Switch, Wiper
510918-01	Monitor, Sony Watchman
511383-01	Radio, w/cassette/changer XRC 6100
690429	Louver, dash vent center console, 2.5", black
690430	Louver, dash vent, top & side, 2", black
601762	Adapter, 2.5"-2.0", dash vent

A/C control available from Acme (800-552-2263)

Exhaust brake, trip reset, headlight, and dimmer switches as well as gauges are Freightliner parts.

See entertainment section for Sony Watchman assy.

2001 360XC DIESEL PUSHER

DECALS

For reference only

There are no decals on the exterior of the 2000 Land Yacht 35ft. diesels.

Many places, especially the logos, will appear to be decals but are actually painted.

Each vehicle has been provided with a sheet which lists the color codes on that particular motorhome.

Also, each motorhome is shipped with touch-up paint for each color.

A back-up color chart for each motorhome is kept in Airstream's files. If calling Airstream for this information ask for "Sales" and have the serial number available for them.

2001 360XC DIESEL PUSHER

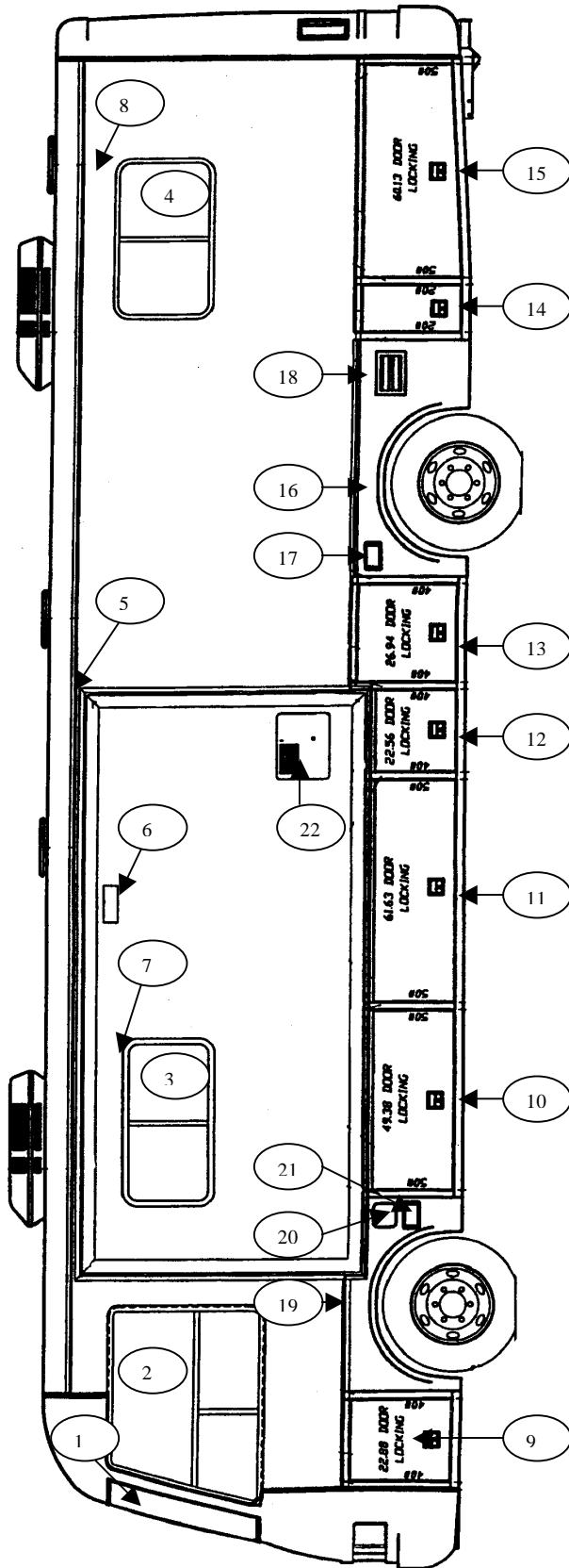

2001 360XC DIESEL PUSHER

DOORS/WINDOWS/AWNINGS, RS

(Hardware such as hinges, locks and latches are located in the **hardware** section of this book)

1) 371388	Windshield, RS
2) 371365-01	Cab window, RS
3) 371366-25	Window, RS slider, 22"x43"
4) 371366-24	Window, RS slider, 26"x43"
5) 702949-04	Cover, roll-up slide out
6) 511152-01	Vent cover, range hood
7)**	Awning, window 6'
8)**	Awning, window, 5'
9)* 922584-06	Compartment door, Assy.-locking, 22.88"
10) 922582-01	Compartment door, Assy.-locking, 49.38"
11) 922582-02	Compartment door, Assy.-locking, slide, 61.63"
12)922582-03	Compartment door, Assy.-locking, 22.56"
13)922584-05	Compartment door, Assy.-locking, 26.94"
14)922584-04	Compartment door, Assy.-non-locking, 13.13
15)922585-01	Compartment door, Assy.-locking, angled, 60.13
16)203261	Fender, rear RS
17)511101-01	Light, docking, Halogen
18)921177	Grille, air intake
19)203262	Fender, RS front
20)201865-02	Fuel fill housing, Polar white
21)511101-01	Light, docking, Halogen
22)690259-05	Access door, water heater
22a)690259-06	Mounting flange, water heater

Doors 10, 11, and 15 require gas spring	381569-01, 50#
Doors 9,12 and 13 require gas spring	381569-03, 40#
Door 14 requires gas spring	381596-04, 20#

* 702949-01 Hardware, slide out cover

** See awning chart page II-10

Not shown

381641

Door fuel fill access

114808-03

Drip cap, RS cab window

2001 360XC DIESEL PUSHER

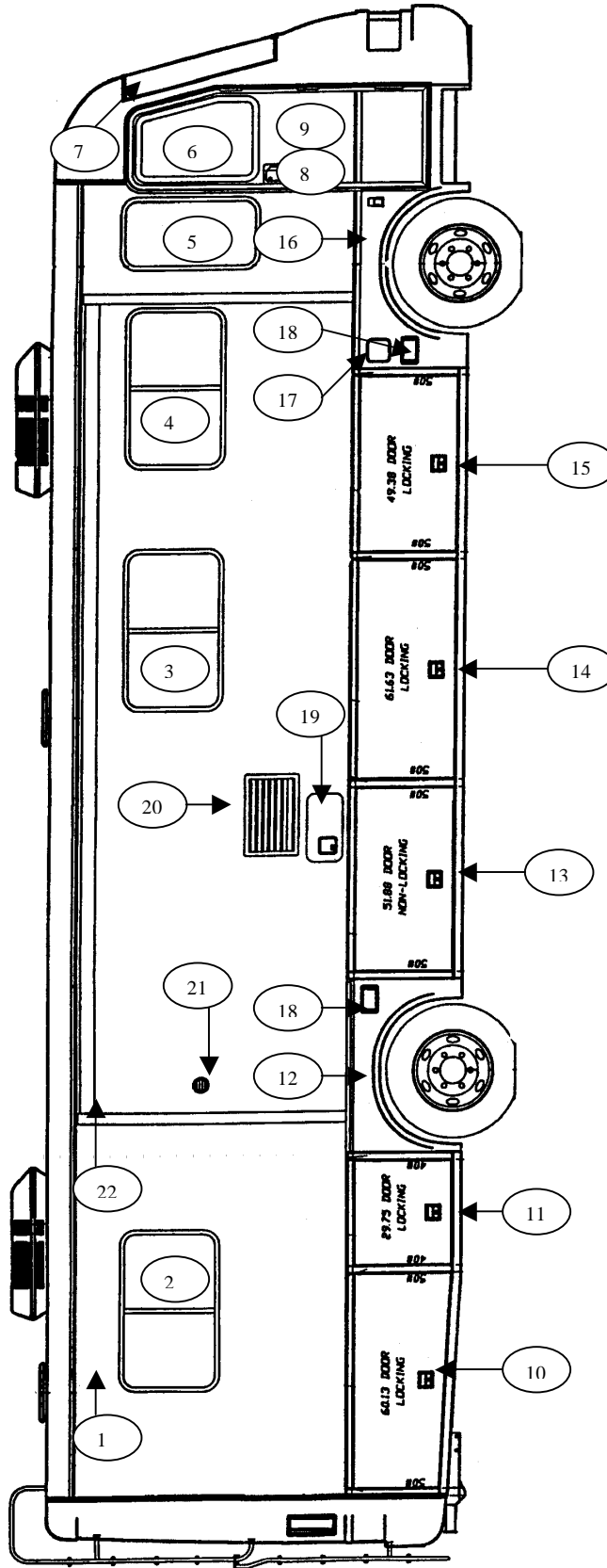

2001 360XC DIESEL PUSHER

DOORS/WINDOWS/AWNINGS, CS

(Hardware such as hinges, locks and latches are located in the **hardware** section of this book)

- | | |
|---------------|---|
| 1)* | Awning, window, 5' |
| 2) 371366-23 | Window, CS slider, 26"x43" |
| 3) 371366-23 | Window, CS slider, 26"x43" |
| 4) 371366-23 | Window, CS slider, 26"x43" |
| 5) 371366-15 | Window, CS, 18.0"x35.62" |
| 6) 371366-16 | Window, angled, main door |
| 7) 371339 | Windshield, CS |
| 8) 922451 | Screen door assy. |
| 9) 110413 | Main door assy. |
| 10) 922585-02 | Compartment door assy., angled, CS rear, 60.13" |
| 11) 922584-03 | Compartment door assy., locking, 29.75" |
| 12) 203259 | Fender CS rear |
| 13) 922583 | Compartment door assy., non-locking, 51.88" |
| 14) 922582-02 | Compartment door assy., locking, 61.63" |
| 15) 922582-01 | Compartment door assy., locking, 49.38" |
| 16) 203260 | Fender, CS front |
| 17) 201865 | Fuel fill housing, Polar white |
| 18) 511101-01 | Light, docking, Halogen |
| 19) 690274-05 | Door, Hydroflame furnace |
| 20) 690340-03 | Refrigerator, exterior access door |
| 21) 381539 | Washer/dryer vent kit, round |
| 22) * | Awning, patio, 17' |
- Doors 10, 13, 14, and 15 require 50# gas spring 381569-01
Door 11 requires 40# gas spring 381569-03

Not shown

- | | |
|-----------|--|
| 381641 | Fuel fill door |
| 452728 | Fuel fill cap |
| 114808-04 | Drip cap, cab window, CS |
| 914163 | Bracket, main door prop rod |
| 381697 | Cover, step slide |
| 386067-03 | Medallion, 70Th Anniversary, Black, 4.375" |

*See awning chart page II-10

2001 360XC DIESEL PUSHER

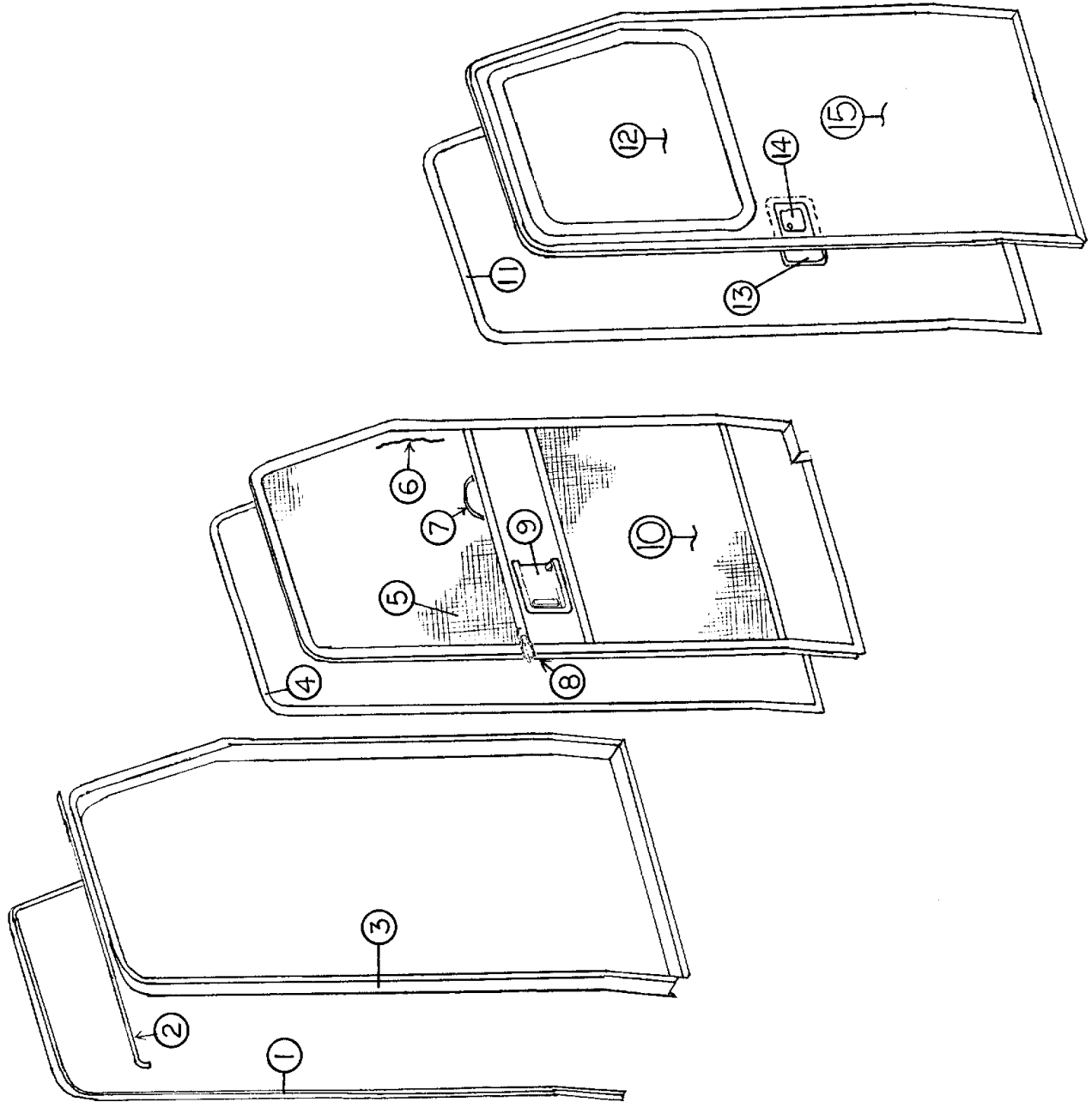

2001 360XC DIESEL PUSHER

MAIN and SCREEN DOOR

- 1) 114829 Trim, inside doorjamb
- 2) 114966 Drip cap, main door/window
- 3) 922519 Jamb, main door
- 4) 365013-01 Gasket, screen door, low-density foam
- 5) 380079 Screen, plastic mesh
- 6) 200518 Spline, gray, round, screen installation
- 7) 380004 Pull handle, screen door w/screws
- 8) 381454 Latch, screen door, double action, Bullet
- 9) 203000 Closeout ,plastic, sliding, screen door, (gizzy)
- 10) 922451 Screen door assembly
- 11) 365045 Seal, main door
- 12 371366-16 Window, angled, main door
- 13) 203127 Cover, inner door lock pocket, plastic
- 14) Door lock: the main door lock is made up of five separate parts-
see hardware in Section III for listing
- 15) 922521-100 Main door assembly

2001 360XC DIESEL PUSHER

AWNINGS

DRIFTWOOD

702679-52	Awning, patio, 19'
702679-05	Awning, window, 5'
702679-55	Awning, window, 6'
702679-54	Awning, door, 4'

BLUE BAYOU

702679-57	Awning, patio, 19'
702679-36	Awning, window, 5'
702679-37	Awning, window, 6'
702679-38	Awning, door, 4'

AUTUMNWOOD/ROMAN SANDS

702679-58	Awning, patio, 19'
702679-40	Awning, window, 5'
702679-41	Awning, window, 6'
702679-43	Awning, door, 4'

EMERALD CLAY

702679-56	Awning, patio, 19'
702679-45	Awning, window, 5'
702679-46	Awning, window, 6'
702679-48	Awning, door, 4'

AWNING MOUNTING HARDWARE

702679-11	Hardware, patio awning, tall
702679-12	Hardware, window awning, 5&6'
702679-27	Hardware, door awning

2001 360XC DIESEL PUSHER

DRAPES/BLINDS/VALANCES

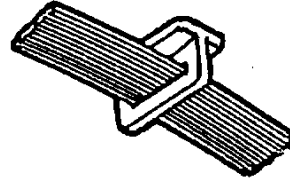

101220
track, stand-off

101217
track, curtain

700044
glides, w/elastic "T"

200784	End, curtain track, CS	
200785	End, curtain track, RS	
703029	Shade, front windshield wrap, set	
964746	Stop, front windshield wrap, oak 3.5" x 43.0"	
702818	Shade, Kool Screen, black, cab	
702969-29	Shade, single, pleated night	45.0" x 29.0"
702968-29	Shade, pleated, day/night	45.0" x 29.0"
702968-30	Shade, pleated, day/night	45.0" x 25.0"
385963	Bracket, valance mounting, side	
964121-01	Valance, lounge/dinette, RS 64.25"	
964792-02	Valance, bedroom	
964990	Shadow box, bedroom	48.88" x 22.75"
964989	Shadow box, dinette	60.25" x 29.75"
964988	Shadow box, lounge	50.75" x 37.00"
964987	Shadow box, lounge	60.25" x 22.75"

2001 360XC DIESEL PUSHER

*ELECTRICAL
110 VOLT

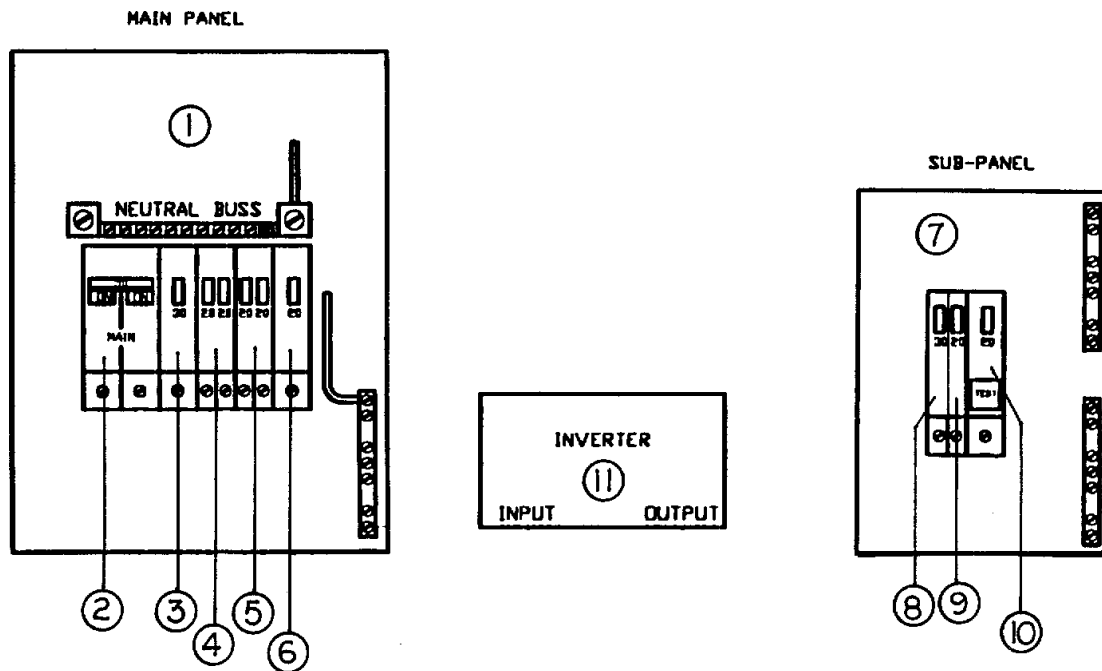

- 1)511571 Breaker box, main
 - 2)510724 Breaker, double pole,50 amp, Square D
 - 3)510663 Breaker,30 amp, Square D
 - 4)510662 Breaker, double pole,20/20,Square D
 - 5)510662 Breaker, double pole,20/20,Square D
 - 6)510678 Breaker,20 amp, Square D

 - 7)511041 Breaker box, sub-panel, Westinghouse
 - 8)510564-02 Breaker,30 amp, Bryant
 - 9)510564-01 Breaker,20 amp, Bryant
 - 10)510564-20 Breaker,20 amp, GFI, Bryant
 - 11)511418-01 Inverter/charger, 2000watt
- not shown:
- 511418-09 Inverter/charger, dual 15-amp output, CSA only
 - 510564-15GFI Breaker, 15A. GFI, Bryant, CSA only
 - 511418-02 Switch, on/off, remote
 - 511418-03 Fuse holder, 300 amp

*see ENTERTAINMENT section for radio, VCR, TV, antenna etc.

2001 360XC DIESEL PUSHER

ELECTRICAL

110 VOLT

511149-04	Power cord, 50-amp w/male end
511533	Switch over box, 50 amp, city-power to gen.
381435	Hatch, power cord, white
511580	Generator, Onan 8.0 QD
510103	Hour meter, Hobbs
511289	Breaker kit,30 amp, Onan
511278	Lock out,110 volt disconnect
510676-01	Outlet,exterior,gray,110 volt
500785	Outlet, duplex brown
511207	Cover, weatherproof receptacle
511023	Tester, circuit analyzer,3-wire (provided loose in vehicle)
10469W	30M-50F Adapter plug,18",loose item

2001 360XC DIESEL PUSHER

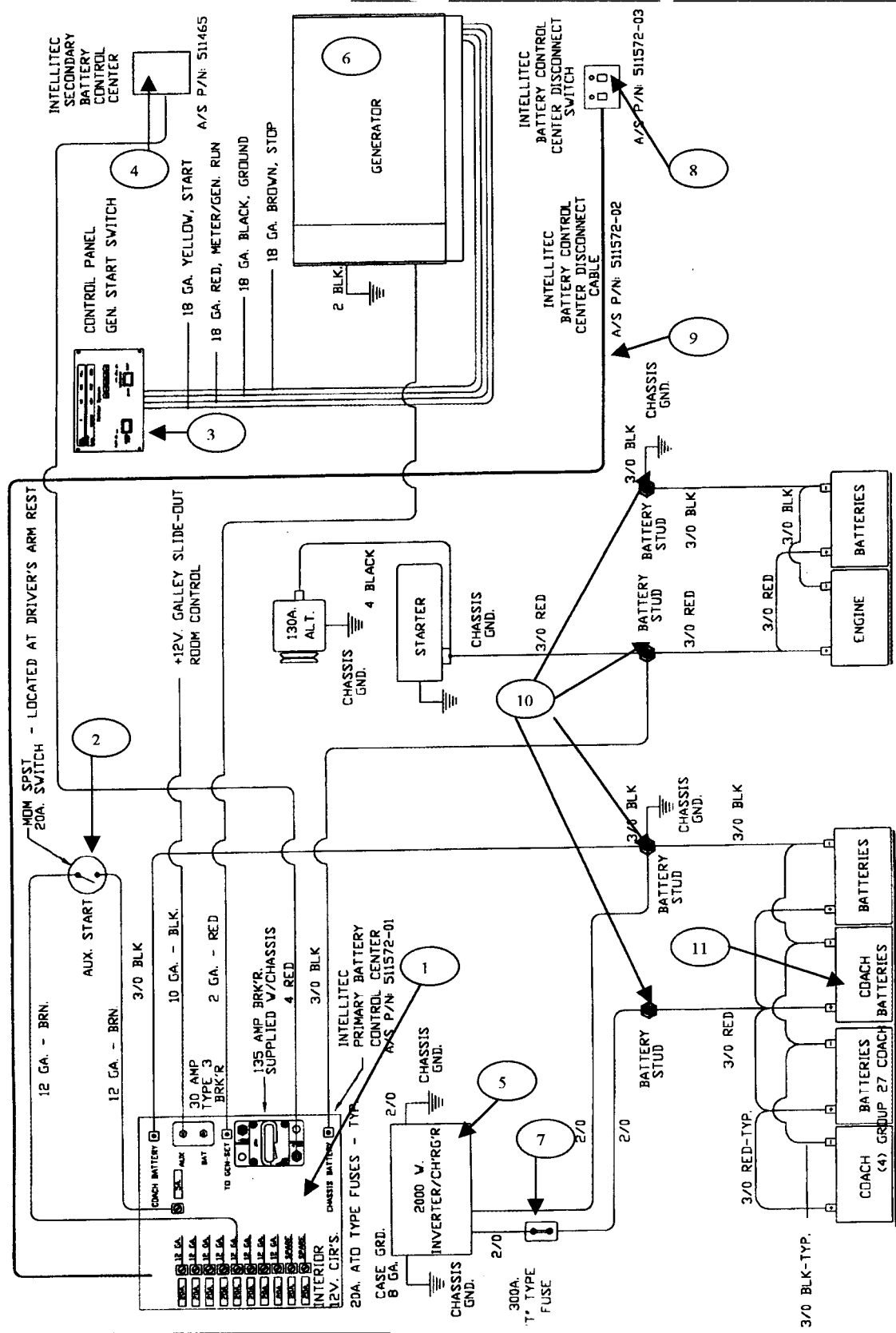

2001 360XC DIESEL PUSHER

*ELECTRICAL 12 VOLT-CHASSIS

- | | |
|---------------|---|
| 1) 511572-01 | Primary battery control center, Intellitec |
| 2) 511579-103 | Auxiliary start switch, located in armrest |
| 3) 511446 | Control panel, Generator start switch |
| 4) 511465 | Secondary battery control panel |
| 5) 511418-07 | 2000 W inverter/converter |
| 6) 511580 | Generator, 8.0 QD |
| 7) 511418-03 | Fuse holder & fuse(300 amp) |
| 511418-04 | 300-amp fuse only |
| 8) 511572-03 | Battery disconnect switch, Intellitec |
| 9) 511572-02 | Disconnect switch cable, Intellitec |
| 10) 511510-02 | Junction block, stud type, Red.
(Paint black for ground) |
| 11) 511132 | Battery, deep cycle |
| 511309 | LPG detector |
| 500475-30 | Breaker, 12 volt DC, 30 Amp, w/ears |
| 510947-50 | Breaker, 12 volt DC, 50 amp |
| 511418-05 | Battery temperature sensor |
| 511561 | Daytime running light module (CSA only) |
| 510844-01 | Socket, relay for Power Gear jack system |
| 510844-02 | Relay, Bosch, for Power Gear jack system |
| Not Shown: | |
| 511571-01 | Load center, 100A w/flush cover, CSA only |

2001 360XC DIESEL PUSHER

ARMREST, CENTER CONSOLE SWITCH & DASH PANELS

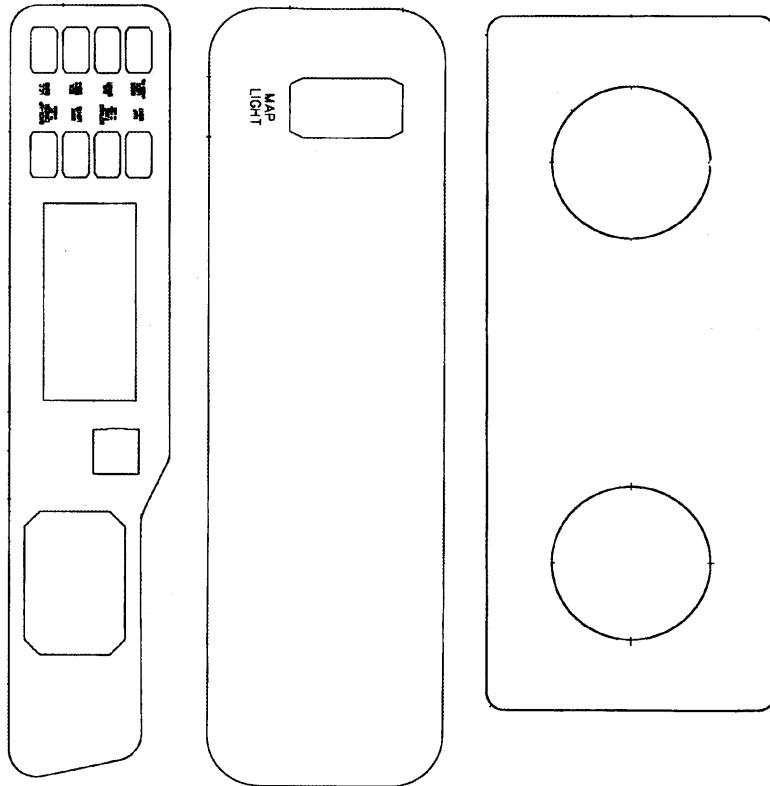

511576*	511574	511573
Driver switch Panel	Pass. Switch Panel	Center Console (center of dash)

Switches

511579-100	Back-up camera, Door lock
511579-101	Drive, map, aisle, docking lights
511579-102	Defrost fans, HI-LO
511579-103	Aux start, I.C.C. blink
511579-104	Generator stop/start
511579-105	Switch blank (if needed)
511579-106	LED light & Bezel door unlocked warning
511305-10	Remote exterior mirror
511419-06	Wiper/washer
690430	Vent, louver for center console A/C outlet

*511579 replaced by 511576 on units 710772, 710777, 710773, 710771 & 710774 w/ manual Power Gear Leveling Jack control pad

2001 360XC DIESEL PUSHER

12 VOLT-DASH

510596	Cigarette lighter
510807	Outlet, 12 volt, lighter receptacle
511276	Cover, 12-volt outlet, black
511385-01	Theatre sound system source selector switch
511579-101	Switch, driving light, aisle light,
511419-06	Switch, wiper/washer

*Note: Engine check, head light switch, dimmer, gauges and air dump valve are provided by the chassis manufacturer.

12 VOLT-INTERIOR SWITCHES

511577	Switch body W/rocker switches, 3 gang by the door
511578	Switch cover, 3 gang printed white, at door
511329	Switch, rocker, SPDT, white, hallway
511327	Switch body w/rocker, single, rear ceiling light
511328	Switch cover, printed white, rear ceiling light
511424	Switch, map light, white
381541-02	Switch, roof vent, bathroom
510868	Switch, 4 gang, bathroom
500933	Switch, water heater
511040	Switch, door, momentary, normally on
511506	Remote Gen. start switch (bedroom)
511508-01	Cover, gen. start switch, black (bedroom)
511078	Switch body, illuminated
511083-02	Cover, switch, 3 & 4 gang
511513	Light, green LED, battery switch indicator

2001 360XC DIESEL PUSHER

ELECTRICAL 12 VOLT-INTERIOR LIGHTS

500960-02 680085	Light, fluorescent, recessed, 20.63" Bulb, fluorescent, #F8T5-CW
500960-01 680084	Light, fluorescent, recessed, 14.75" Bulb, fluorescent, #F8T5-CW
511387 50085-02	Light, decorative, dinette, Acrylic Tiffany Bulb, incandescent, #1141
511298 511298-02 510689	Wall lamp, 12 volt Shade, wall lamp, round Bulb incandescent, #1076
511297 511137-100	Light, halogen w/ switch Bulb, halogen, JC-10, wedge base
500842 680084	Light, fluorescent, 12" x 5.5" x 1" Bulb, fluorescent, F8T5-CW
511361	Light, courtesy, flush mount, walkway, black (no separate bulb)
511422 511137-100	Light, map, halogen, white Bulb, halogen, JC-10, wedge base
500956 681924	Light, wardrobe w/switch Bulb, wardrobe light, #581
511417 510689	Wall light, Demi-sconce, slide out Bulb, incandescent, #1076
511248 50085-02	Light w/switch, single incandescent Bulb #1141

2001 360XC DIESEL PUSHER

ELECTRICAL

12 VOLT-EXTERIOR LIGHTS

511163	Light, compartment
510672-02	Porch light, white(high on side of unit)
510732	Utility light#1327 (by door)
511101-01	Light, docking, halogen, chrome bezel
201991	Housing, docking light
511401-01	Tail lamp assy. LH Ford, 7452RV, w/bulbs & sockets
511401-02	Tail light assy. RH Ford 7453RV, w/bulbs & sockets Bulb and socket individual P/N are on page I-13
511154-02	Light strip,3rd brake light,1"x10"
510984-01	Light, clearance, red
511361	Light, license plate
511248	Light w/switch, single incandescent bulb
511550-01	Head light, dual, CS
511550-02	Head light, dual, RS
*511562-01	Socket, front turn and parking light
511562-02	Bulb, dual filament, turn and parking light
511250-02	Light ,side marker, amber
511400	Light, marker, amber, tear drop
510984-02	Light, clearance, amber
511514	Driving light kit

*Note: The front parking/turn lights are part of the head light assembly.

2001 360XC DIESEL PUSHER

ELECTRICAL

12 VOLT-MICS. EQUIPMENT

510804	Air horn, chrome #981-1
510804-01	Elbow kit, air horn
511512-01	Mirror, Velvac, remote, heated, RS, black
511512-02	Mirror, Velvac, remote, heated, CS, black
511305-10	Switch, remote, heated mirrors
511446	Monitor panel
511162-01	Keyless entry w/remote
511162-02	Transmitter, 4 channel
510802-01	Actuator, door lock, 5 wire
511352	Locking module, centralized
511412	Solar panel, 10 watt
511413	Light, solar panel
510781	Detector, smoke
511309	Detector, LPG
511343	Detector, carbon monoxide
510844	Relay, Bosch, used with leveling jack system
510734	Alarm, back-up
510976	Buzzer, head light warning
511605	Exterior water pump switch

2001 360XC DIESEL PUSHER

BATTERY COMPARTMENT

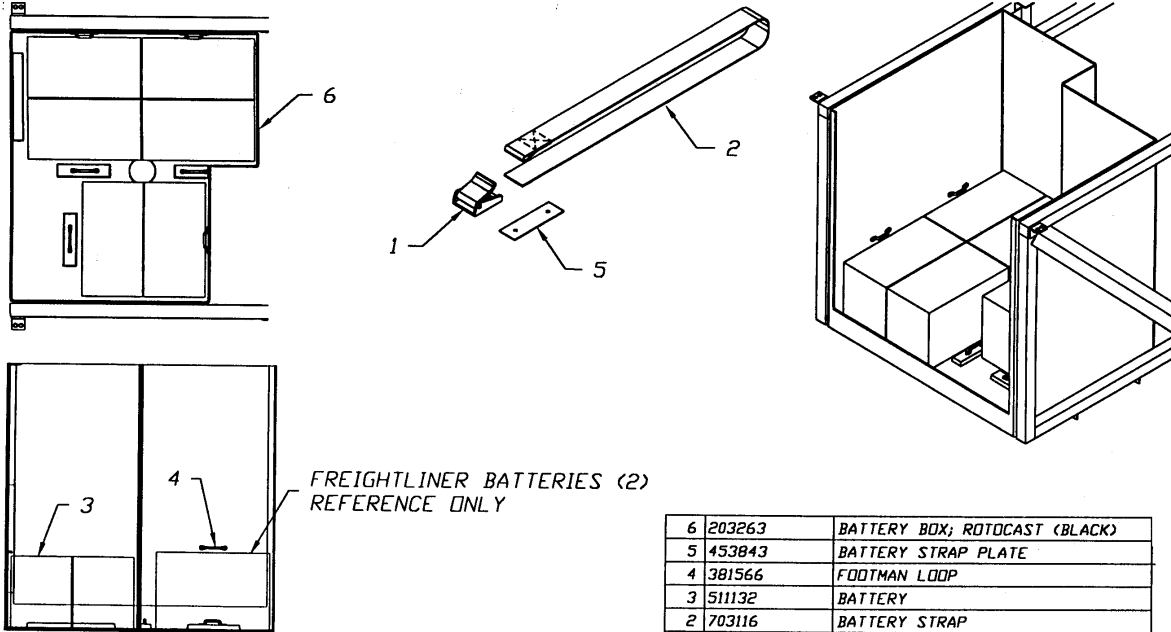

FREIGHTLINER BATTERIES (2)
REFERENCE ONLY

6	203263	BATTERY BOX; ROTOCAST (BLACK)
5	453843	BATTERY STRAP PLATE
4	381566	FOOTMAN LOOP
3	511132	BATTERY
2	703116	BATTERY STRAP
1	381739	BUCKLE; BATTERY STRAP
ITEM	PART NUMBER	DESCRIPTION

2001 360XC DIESEL PUSHER

WINDSHIELD WIPER SYSTEM

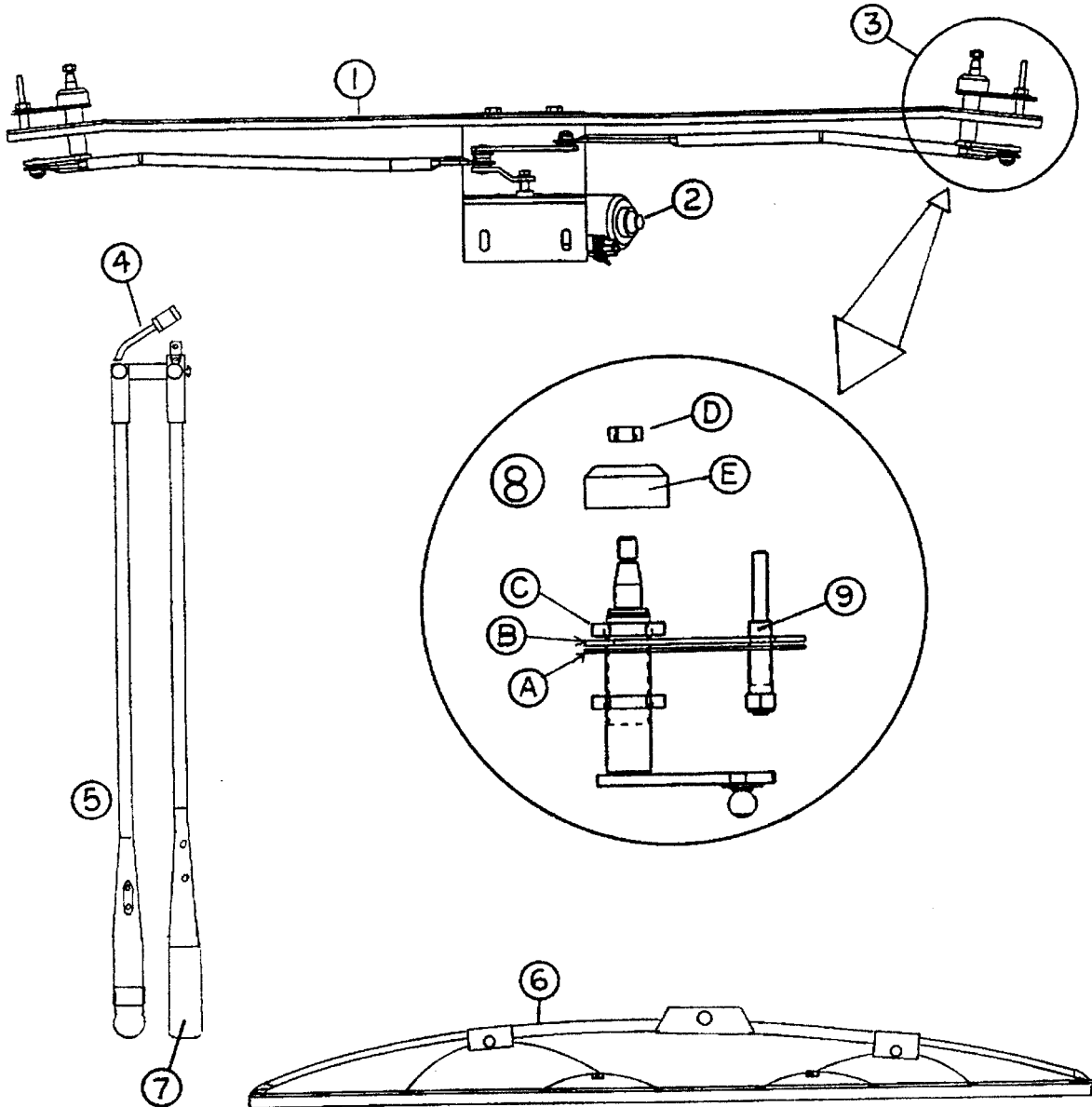

2001 360XC DIESEL PUSHER

WINDSHIELD WIPER

- | | |
|----------------|---------------------------------------|
| 1) 511440 | Windshield wiper assy. |
| 2) 511440-100 | Wiper motor, Ford /Freightliner |
| 3) 511440-102 | Pivot and link assy. |
| 4) 511419-103 | Washer jet and tubing, Trico |
| 5) 511419-104 | Pantograph arm assy, Trico |
| 6) 511419-105 | Blade assy., 28", Trico |
| 7) 511419-106 | Head cover, main arm, black, Trico |
| 8) 511440-107 | Hardware kit, includes the following: |
| a) gasket | |
| b) face plate | |
| c) thin nut | |
| d) 8 mm nut | |
| e) rain shield | |
| 9) 511440-108 | Swivel assy, slave arm, Trico |

Not shown:

- | | |
|-----------|----------------------|
| 511419-06 | Switch, wiper/washer |
| 511844-01 | Relay, Bosch |

2001 360XC DIESEL PUSHER

ENTERTAINMENT

510788-01	Antenna, TV, Winegard
510788-03	Amplifier, TV antenna
511458	Antenna, CB
500976	Outlet, TV jack
500996	Jack, TV/phone, gray
510624-01	Modular phone quick jack, white
500994	Antenna, radio
690436-01	TV, Front, 20" stereo, Sony, MDL., KV-20FS12MT10
690436-02	TV, Rear, 20", stereo, Sony, MDL., KV-20FS12MT12 (has adapter for dual headphone system)
511464-07	Dual speaker/headphone system, bedroom
511464-05	Control, headphone/dual speaker system
511464-06	Harness, headphone/dual speaker system
511464-02	Speaker, 4', 5watt headphone/dual speaker system
511464-03	Grill, speaker, headphone/dual speaker system
500975	Headphones, lightweight
511423	Plug-earphone
511383-01	Radio w/cassette/changer XR C6100
511048	Speaker, Coustic, #HS-40
511385	Mobile theater sound system, Sony
511385-01	Electronic source selector switch
511385-02	Amplifier module, Theater sound system
511385-03	Cube speaker w/bracket
511385-04	Speaker, 6"x9", Theater sound
511385-05	Grill, for 6"x9" speaker
511385-06	Output harness
511385-07	Input/output harness
511385-08	Source harness
511488-03	Patch-cord, radio to amplifier
511385-10	3" flush mount speaker
511385-11	3" flush mount speaker grille, white
511385-12	Grill, 3", speaker, black
511385-13	Complete universal wire harness for sound system
511191	CD changer, 10 disc, Sony CDX-636
690337	Video cassette player, Audiovox
511310	Video control center

2001 360XC DIESEL PUSHER

510918-01	Monitor, Sony Watchman
511579-100	Switch, back-up camera, armrest
511044-03	Actuator, two-position camera, interior
201888	Close-out, monitor camera, interior
203032	Close-out, monitor camera, exterior
453032	Camera bracket

2001 360XC DIESEL PUSHER

SECTION III F through H

FASTENERS

Rivets	III-1
Screws.....	III-3

FLOOR COVERING

Carpet	III-4
Tile.....	III-4
Floor mats.....	III-4

FURNITURE

Interior & Misc. doors.....	III-5
Mirrors.....	III-6
Drawer faces & boxes.....	III-7
Bed room	III-8
Bath	III-9
Galley.....	III-10
Lounge	III-12
Cab	III-13

HARDWARE

Exterior, main & screen door.....	III-14
Exterior compartments.....	III-17
Slide out	III-18
Awning	III-21
Interior	III-22
Window.....	III-26

2001 360XC DIESEL PUSHER

*FASTENERS

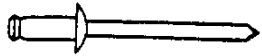

330126-02
rivet, pop
dia. 1/8 "
grip range .126-.187
stainless steel body
stainless steel mandrel

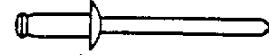

330126-03
rivet, pop
dia. 1/8 "
grip range .126-.250
stainless steel body
stainless steel mandrel

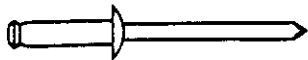

330136-04
rivet, pop
dia. 1/8"
grip range .313-.375
stainless steel body
stainless steel mandrel



330031-03
rivet, pop
dia. 3/16"
grip range .125-.250
stainless steel body
stainless steel mandrel



330031-03
rivet, pop
dia. 3/16"
grip range .126-.250
stainless steel body
steel mandrel



320108-01
rivet, bulb tite, w/washer
dia. 3/16"
grip range .050-.187
aluminum body
aluminum mandrel

*Common bolts and screws readily available at local hardware outlets have not been listed.

2001 360XC DIESEL PUSHER

*FASTENERS



330139-02
dia. 1/4"
grip range .350-.625
stainless steel body
stainless steel mandrel



330139-01
dia. 1/4"
grip range .080-.375
stainless steel body
stainless steel mandrel

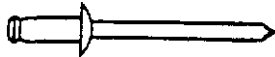

330127-03
dia. 1/8"
grip range .063-.125
aluminum body
aluminum mandrel



300101
1/8" I.D.
washer, aluminum



330127-05
dia. 1/8"
grip range .251-.312
aluminum body
aluminum mandrel

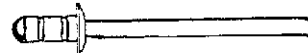

330137
dia. 1/8"
grip range .039-.189
aluminum body
steel mandrel

*Common bolts and screws available at local hardware outlets have not been listed.

2001 360XC DIESEL PUSHER

*FASTENERS



320122
screw, pan head, Phillips
black
#4x1/8" (glove box tray)



320114-04
screw wood oval head, Phillips
antique brass
#5x1/2"



320114-05
screw wood, oval head, Phillips
antique brass
#5x5/8"



320115-06
screw wood, flathead, Phillips
stainless steel
#6x1.00"

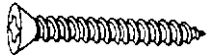

320124-06
screw, flathead, Phillips
stainless w/white head

Outlets have not been listed.

*Common bolts and screws readily available at local hardware

2001 360XC DIESEL PUSHER

FLOOR COVERING

702793-10	*Carpet, Regal/Oatmeal, Roman Sands
700173-01	Carpet padding, 1/2"
381346	Floor mats
701538	Carpet, Velour gray, storage compartments
201709-02	Extrusion, trim molding, black, baggage compartment.
702903-01	Tile, Idaho Beige-13x13
702903-03	Matt, tile support
702903-04	Epoxy grout
702903-05	Schluter strip
702550-01	Mat, entrance
702549	Mat, entrance, w/Airstream logo
702812-02	Step, tread, round, black
702893	Step tread, smooth rubber

*See sample chart provided to your sales department for more carpet and upholstery part numbers.

2001 360XC DIESEL PUSHER

FURNITURE

DOORS-INTERIOR

800557-644	Door frame	10.50" x 20.00"
800557-234	Door frame	10.50" x 32.50"
800557-334	Door frame	11.50" x 19.00"
800557-114	Door frame	16.00" x 60.00"
800597-744	Door, raised panel	10.25" x 29.50"
800597-734	Door, raised panel	11.00" x 13.25"
800597-594	Door, raised panel	11.50" x 18.50"
800597-064	Door, raised panel	12.25" x 16.00"
800597-074	Door, raised panel	12.25" x 21.00"
800597-794	Door, raised panel	12.75" x 28.00"
800597-084	Door, raised panel	16.00" x 16.00"
800597-784	Door, raised panel	16.00" x 29.50"

MISCELLANEOUS DOORS

801225-014	Door panel, refrigerator, upper door , Oak	
801225-034	Door panel, refrigerator, lower door, Oak	
961413-05	Door, slider, bath,	34.5" x 72.00"
961413-04	Door slider assembly,	25.5" x 72.00"
702416-02	Shower door	
800881-164	Door louvered, oak	12.75" x 34.75"
800881-144	Door, louvered oak	12.00" x 33.25"

2001 360XC DIESEL PUSHER

FURNITURE

MIRRORS

372210-11	Mirror, beveled 4 sides	7.75" x 19.59"
372210-19	Mirror, beveled 4 sides	8.00" x 41.50"
372210-02	Mirror, beveled 4 sides	8.62" x 16.62"
372211-04	Mirror, beveled 3 sides	11.00" x 16.75"
372211-02	Mirror, beveled 3 sides	14.00" x 16.75"
372211-01	Mirror, beveled 3 sides	15.25 "x 16.75"
372212-01	Mirror, beveled 2 sides	12.25" x 25.0"
371262-34	Mirror, safety glass	7.62" x 29.62"
371262-15	Mirror, safety glass	10.56" x 17.12"
371262-05	Mirror, safety glass	16.00" x 60.00"
372203-13	Mirror, safety glass	16.25" x 29.00"

2001 360XC DIESEL PUSHER

FURNITURE

DRAWER FACES

800599-774	Drawer face	4.75" x 17.25"
800599-584	Drawer face	4.75" x 21.50"
800599-404	Drawer face	7.00" x 10.25"
800599-634	Drawer face	7.75" x 60.75"
800599-654	Drawer face	8.00" x 10.50"
800599-464	Drawer face	8.00" x 17.25"
800599-234	Drawer face	8.00" x 21.50"
800599-294	Drawer face	11.75" x 21.50"
800599-764	Drawer face	12.00" x 10.50"

DRAWER BOXES

964906-02	Drawer box	2.75" x 19.50" x 18.00"
964910-05	Drawer box	5.00" x 8.50" x 18.00"
964910-02	Drawer box	5.00" x 10.00" x 18.00"
964907-10	Drawer box	6.00" x 8.50" x 14.00"
964907-02	Drawer box	6.00" x 8.50" x 18.00"
964907-03	Drawer box	6.00" x 19.50" x 18.00"
964908-03	Drawer box	8.00" x 13.00" x 20.00"
964909-01	Drawer box	10.00" x 8.50" x 18.00"
964909-02	Drawer box	10.00" x 19.50" x 18.00"

964008 Lounge drawer box

200980-01 Tray, silverware, almond

2001 360XC DIESEL PUSHER

FURNITURE

REAR BEDROOM

965123	Wardrobe, CS rear
965107-004	Faceframe, CS rear wardrobe
962818-01	Frame, wardrobe shelf
381527	Speedy shelf strip
965124	Wardrobe, RS rear
965108-004	Faceframe, RS rear wardrobe
962818-01	Frame, wardrobe shelf
381527	Speedy shelf strip
963861-02	Roof locker, rear
964430-01	Face frame, rear roof locker
381449-04	Rail, decorative, brass
381449-05	Post, decorative rail, brass
965127	Bed assembly
963096	Head board, 62.00
203265	Engine cover base, fiberglass
203266	Lid, engine cover, fiberglass
381735	Latch, engine cover lid
380509	Catch, holds lid open, Bargman
203277	Insulator, sound, Bed liner
203277	Insulator, sound/heat, Engine cover
381263	Gasket, engine cover
801232	Close-out, TV, oak, 16.25" x 15.25"
964073	Base assembly, rear TV
965106-004	Face frame, bedroom TV cabinet, specify TV make
965151	Magazine rack assembly, bedroom

2001 360XC DIESEL PUSHER

FURNITURE

*BATH

201999	Shower stall, almond
201902	Ceiling liner, shower
381631-01	Sky light, plastic, neo angle, 22"x22"
203154-01	Inner dome, sky light, neo angle
965221-01	Laundry/TV cabinet
965105-004	Face frame, TV/laundry cabinet
965119	Lavy assembly
965103-004	Face frame, lavy
965153-01	Lavy top, Corian
965120	Wardrobe assembly, CS, see 965320
965104-00Z	Face frame, CS wardrobe assembly
965320	Replaces 965120, has double drawer on right side
965321-00Z	Replaces 965104-00Z, double drawer on the right side
965125	Medicine cabinet, sidewall
965109-004	Face frame, sidewall medicine cabinet
965126	Medicine cabinet, divider wall
965110-004	Face frame, divider wall medicine cabinet
703053	Border, wall paper trim
703106	Border trim, Golden Oak, Mystic Mint, Mandalay Blue

*Bath fixtures may be found in the hardware section-
if connected to or drains water look in plumbing.

2001 360XC DIESEL PUSHER

FURNITURE GALLEY AREA

964492	Dinette seat base, RH
964496	Dinette back, RH
964498	Dinette cushion support, RH, 37.63"
964334-02	Flex spring seat, 21.63" x 38.0"
964493	Dinette seat base, LH
964497	Dinette back, LH
964499	Dinette cushion support, LH 37.63"
964334-02	Flex spring seat, 21.63" x 38.0"
703125-02	Top dinette seat, urethane buckskin
962720-05	Dinette table, fixed
965187-004	Table top, Nomar finish, 26.0" x 38.0"
922177-03	Leg, hardwood, 30.50
965118-02	Roof locker, dinette aft
965189-024	Face frame, dinette roof locker, aft
965118-01	Roof locker, dinette, forward
965189-014	Face frame, dinette roof locker, forward
965116	Roof locker, dinette, center
965100-004	Face frame, dinette roof locker, center
964216	Microwave cabinet
964417	Face frame, microwave cabinet
965140	Refrigerator cabinet w/pantry
964642	Face frame, refrigerator cabinet w/pantry
381551-01	Pantry rack
381551-02	Wire basket

(Continued)

2001 360XC DIESEL PUSHER

FURNITURE GALLEY AREA

964213-03	Galley assembly ,forward
964424	Face frame, forward galley assembly
965111-01	Galley assembly, cook top section
965095-004	Face frame, aft galley assembly
965154-01	Galley top, Corian
601633-06	Sink, porcelain, almond
964411-01	Sink cover, RH
964410-01	Sink cover, LH
964383-01	Range covers, Corian
965117	Roof locker, galley
965101-004	Face frame, galley roof locker
963990	Magazine rack
965157	Spice cabinet assembly
965145-004	Face frame, spice cabinet

2001 360XC DIESEL PUSHER

FURNITURE LOUNGE AREA

965114	Roof locker, lounge, RS
965098-004	Face frame ,lounge roof locker
965114	Roof locker, lounge, CS
965099-004	Face frame, CS lounge roof locker
703088-01	Recliner, Phase III
*703069-399	Sofa, jack knife, 74", Roman Sands
965191	End table
964416-004	Face frame, end table
965188-004	Top, end table
964227	Letter rack

*Changing the-(dash) number to:

350 = Georgia Peach
320 = Golden Oak
470 = Mandalay Blue
379 = Mosaic Blue
460 = Mystic Mint

2001 360XC DIESEL PUSHER

FURNITURE/TRIM CAB AREA

964547-03 203223	Armrest, CS Cup holder, black, 3.13"
964546-03 702192-68	Armrest, RS Map pocket, either side
965199 965061-004 371374-01 371375-02 965196-004	Roof locker, front(above windshield) Face frame, front roof locker Glass, tinted, 9.88" x 21.56" Glass tinted, 8.38" x 17.81" Face frame TV cabinet specify TV make
965148 965147-004 965205 965203-004 965204 965202-004	Cabinet assembly cab area Face frame, cab cabinet Side cabinet, cab, RS Face frame, RS cab cabinet Side cabinet, cab, CS Face frame, CS cab cabinet
702897-05 702898-02 511503	Driver seat, power Passenger seat, non-power Kit, Vibrasonic seat
964991 800631-004	Step cover assembly Handrail, Oak
381515-04	Visor, front windshield
203158-01 203139-01 203040	Cover, A-post, RS Cover, A-post, CS Cover, center windshield post

2001 360XC DIESEL PUSHER

HARDWARE EXTERIOR-MAIN/SCREEN DOOR

TRI-MARK main door lock

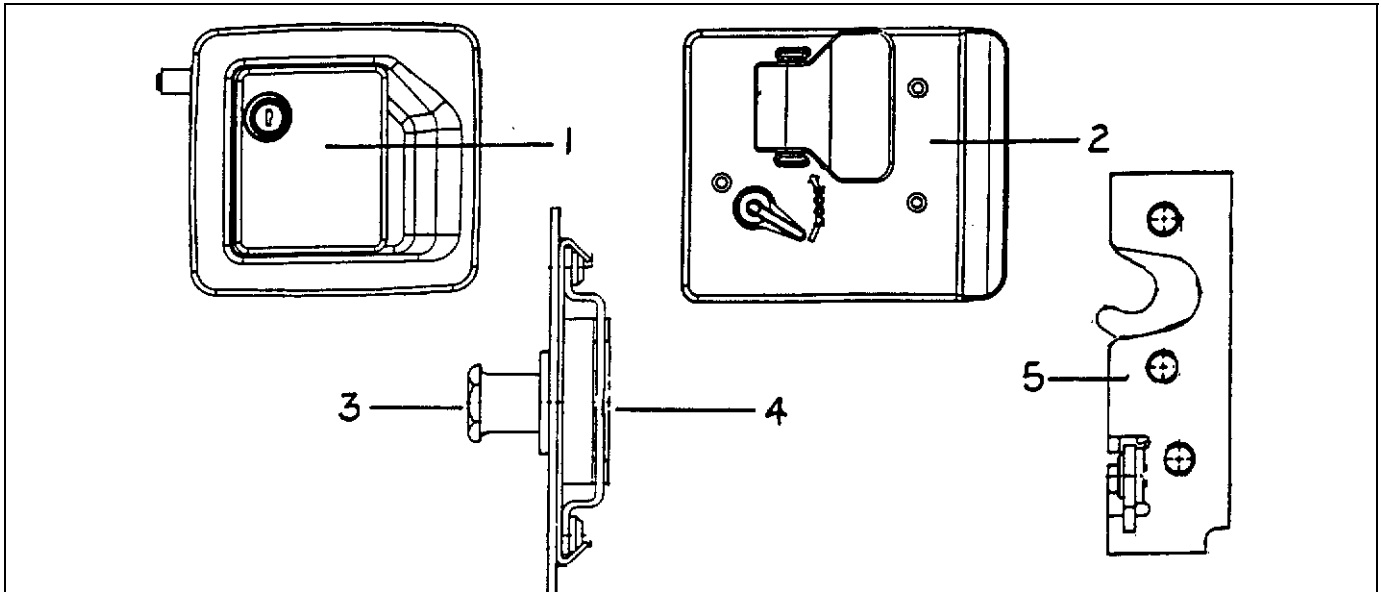

- | | |
|--------------|---------------------------------|
| 1) 381521-01 | outside lock housing |
| 2) 381521-02 | inside lock plate |
| 3) 381284 | Striker bolt |
| 4) 381521-04 | Caged nut |
| 5) 381521-03 | Rotary latch |
| 381521-05 | Screws, inside lock plate |
| 203127 | Cover, inner door lock, plastic |

Dead bolt-Tri-mark

- | | |
|-----------|-------------------------------------|
| 510802-01 | Actuator, door lock,5-wire |
| 381323-01 | Dead bolt assembly |
| 452030 | Bolt, Tri-mark dead bolt |
| 381326 | Striker, 10007 w/Tri mark dead bolt |
| 345321-12 | Screw,#8-32,flat head, black |
| 200772 | Pan, plastic, dead bolt, interior |

2001 360XC DIESEL PUSHER

HARDWARE EXTERIOR-MAIN/SCREEN DOOR

- 381334 Hinge leaf, jamb, main door
- 381336 Hinge leaf, door, main
- 381377 Hinge leaf, screen door
- 385599-075 Bearing, sleeve, main door hinge
- 300118-01 Washer, nylon, main door hinge
- 310024 Hinge pin, .250" x 6.0"

- 381632 Prop, gas spring, 30#(bottom of main door)
- 381634 Bracket, prop, LH curve
- 381633 Bracket, prop, 2"
- 381632-01 Safety clip, end fitting
- 203156 Cover, black, bottom main door prop

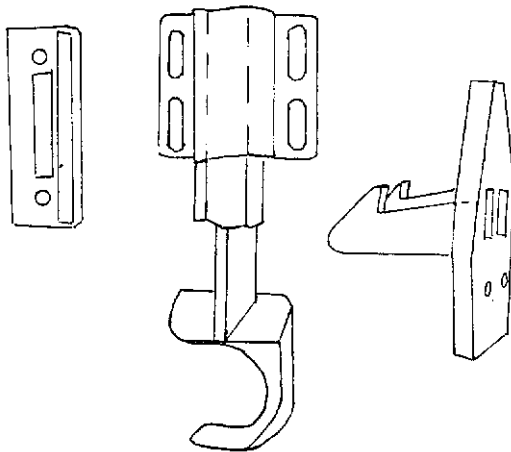

381454 Latch, screen door,
Bullet



381696 Grab handle
embossed "AIRSTREAM"

2001 360XC DIESEL PUSHER



380004 Handle, screen door

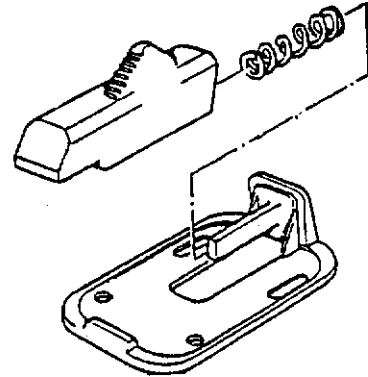

380291 Main door holdback
Used w/housing #380290

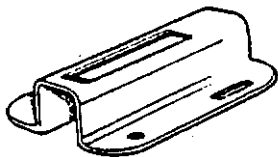

380290 Latch housing,
main door hold back

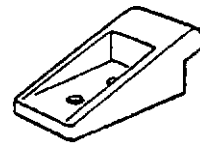

201056 Catch, main door
hold back

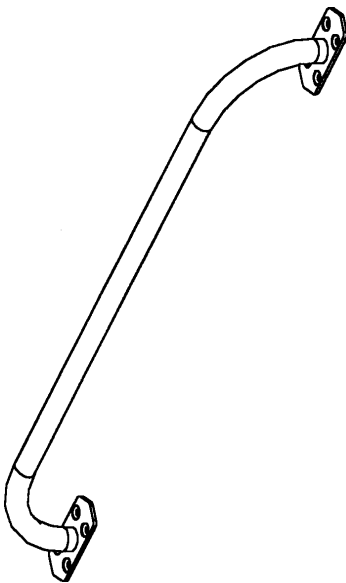

381736-02 Handle, dash
Assist, SS 20.50"

2001 360XC DIESEL PUSHER

HARDWARE EXTERIOR-BAGGAGE COMPARTMENT

381569-01	Prop, spring, gas, 50#
381569-02	Prop, spring, gas, 60#
381569-03	Prop, spring, gas, 40#
381569-04	Prop, spring, gas, 20#
381262	Bracket, prop w/ball, mounts on jamb
914163	Bracket, door prop, mounts on door
381565-01	Handle assembly, locking w/collar
381565-05	Key TM 904
381565-02	Handle assembly, non locking
381565-04	Plunger bolt assembly
381484	Strike, compartment door
381456	Cable, coated
381455	Loop sleeve, crimp on cable clamp
381523-01	Hinge, baggage door
365232	Seal, baggage door
203122	Cover, compartment latch, inside

EXTERIOR-REAR DOOR

381434	Hinge, stainless, 3" x 3"
381227-01	Latch, vise action, curved pawl
385587	Cap, hood bumper

GENERATOR DOOR

381702-03	Latch, double rotary, RH, straight pawl, generator slide
381702-02	Latch, double rotary, LH, straight pawl, generator slide
381702-01	Handle, paddle latch, non-locking w/rods

2001 360XC DIESEL PUSHER

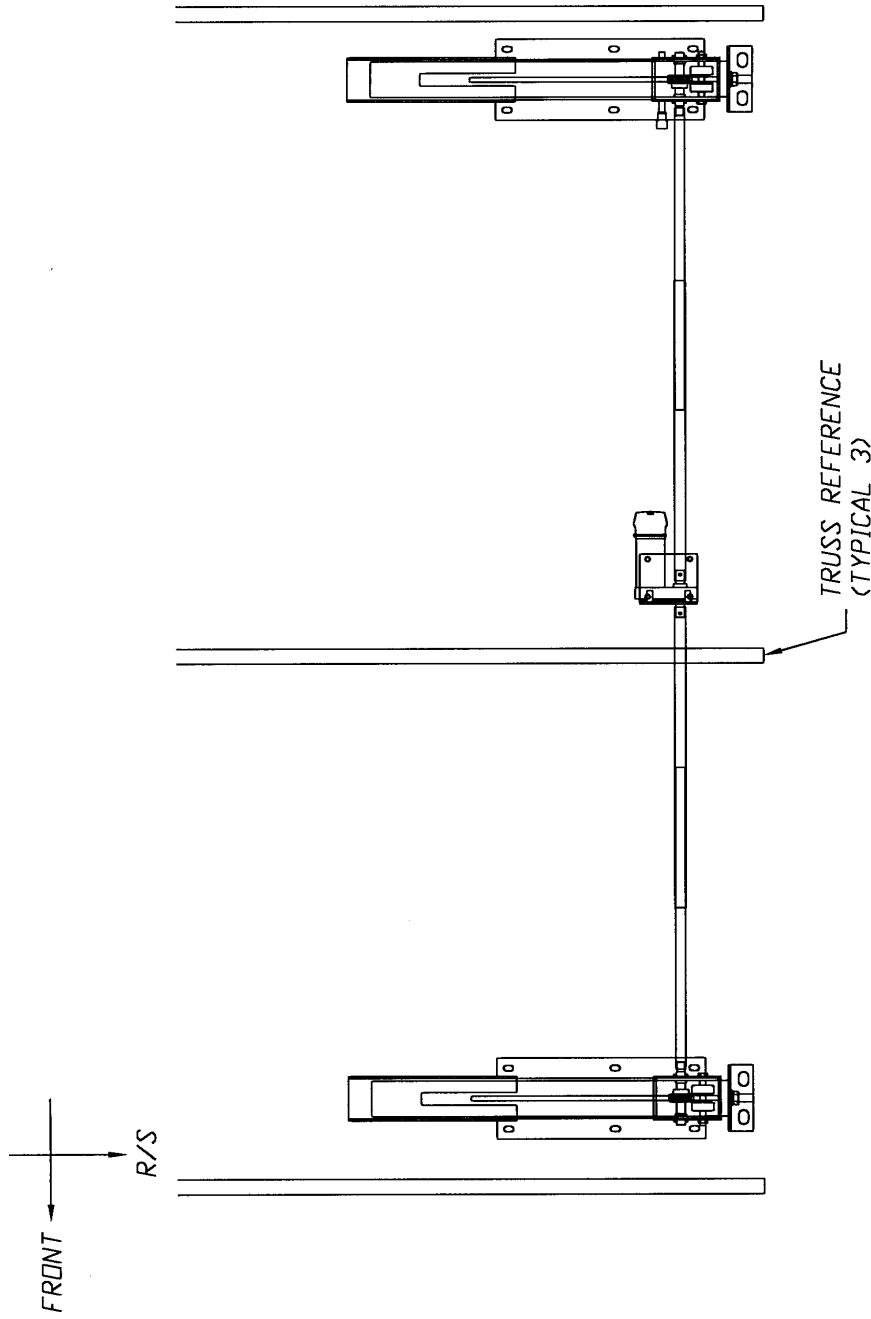

VENDOR: POWER GEAR
VENDOR PART NUMBER: 521649

SHAFT KIT (521247)
(2) 30" - .813 TUBES
(2) 30" - 1.00 TUBES
MOTOR MOUNT BRACKET - 521713

2001 360XC DIESEL PUSHER

HARDWARE EXTERIOR-SLIDE OUT ROOM

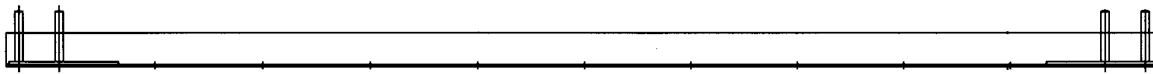
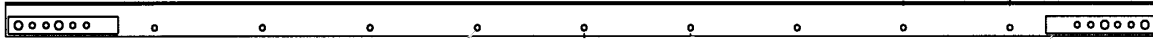

915595 ANGLE, FLOOR MTG., 360 XC SLIDE OUT

INTERIOR-SLIDE OUT ROOM

- 381592-01 Bar, travel lock, 10.25", adjustable
- 381623 Roller, floor slide out

2001 360XC DIESEL PUSHER

HARDWARE

Power gear slide out

FOR REFERENCE ONLY. AIRSTREAM DOES NOT STOCK POWER GEAR PARTS

POWER GEAR CUSTOMER SERVICE AT 800-334-4712 WILL HELP FOR RETAIL OR WARRANTY REPLACEMENT PARTS

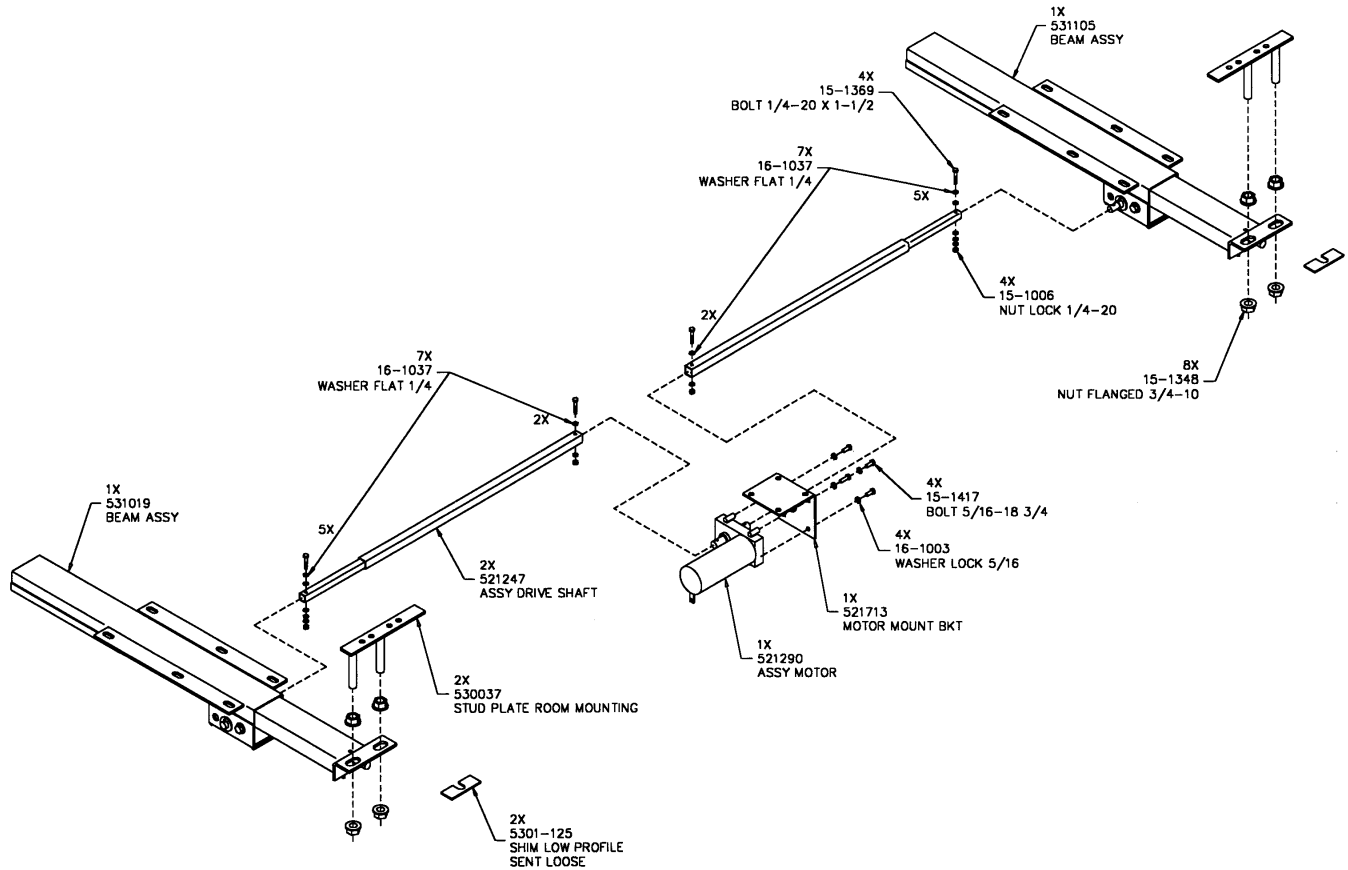

2001 360XC DIESEL PUSHER

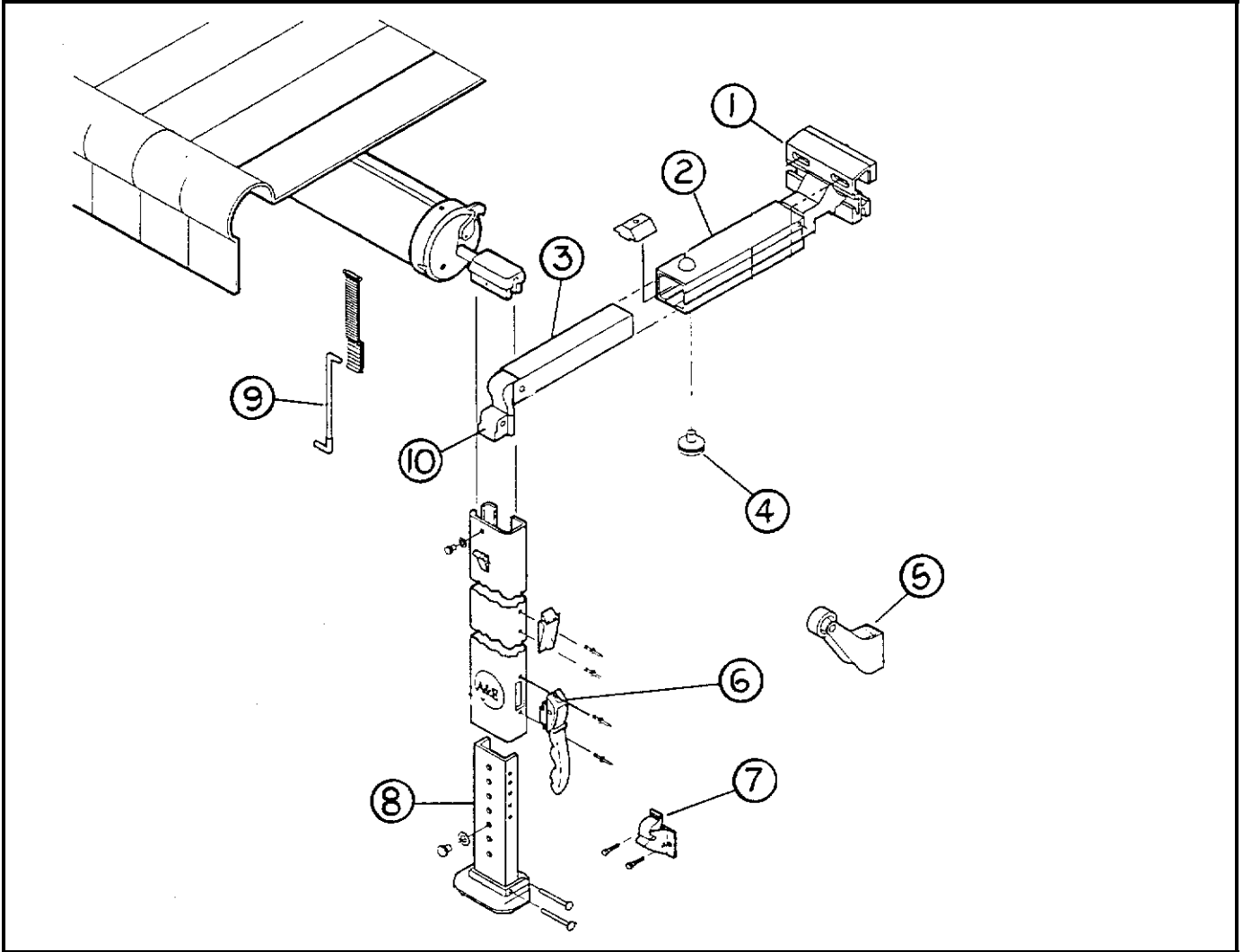

- | | |
|----------------|--------------------------------------|
| 1) 702679-104 | Bracket top, A&E awning |
| 2) 702679-103 | Rafter, main, A&E awning |
| 3) 702679-105 | Secondary rafter, A&E awning |
| 4) 702679-106 | Knob, adjustment, 1 7/8" A&E awning |
| 5) 702679-109 | Door roller, A&E awning |
| 6) 702679-111 | Lift handle, A&E awning |
| 7) 702679-108 | Bracket, bottom mounting, A&E awning |
| 8) 702679-107 | Arm, adjustable, A&E awning |
| 9) 702679-102 | E-Z pull rod, A&E awning |
| 10) 702679-110 | Slider assembly, A&E awning |

2001 360XC DIESEL PUSHER

HARDWARE INTERIOR

381526-01	Drawer slide, 950RV, 14"
381526-03	Drawer slide, 950RV, 18"
381526-05	Drawer slide, 700RV, 22"
381526-06	Rear bracket, adjustable, drawer slide
380203-01	Piano hinge, 1/8" pin, clear anodized
381000-06	Hinge, .092 stainless, 2.0" open, 56" long
380210	Hinge, 2", bed top
381443-01	Sliding door set, includes carriers, top plate and track
200009	Sliding door guide
*381385	Dual lock #400
*381386	Dual lock #170

*These two parts work similar to Velcro but have interlocking knobs rather than hooks and loops.

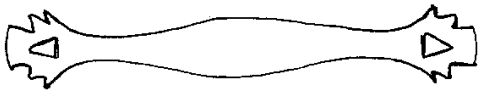

381599 Pull handle,
drawer/door, antique brass

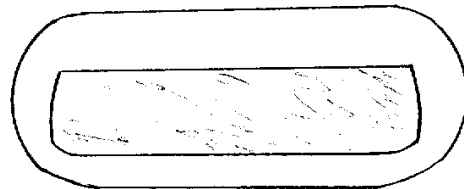

381576 Pull handle,
brass

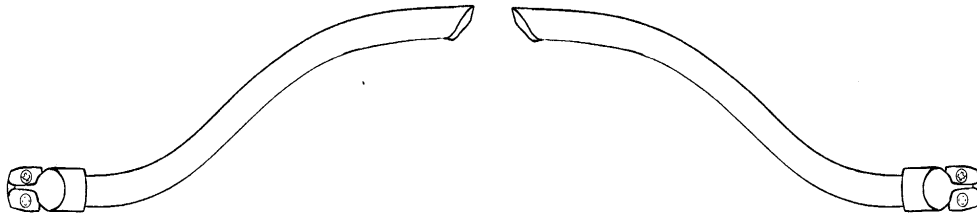

381699 Handle, exit, interior, doorjamb mount

2001 360XC DIESEL PUSHER

HARDWARE
INTERIOR

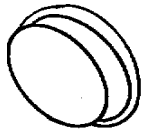

201427 Finger pull,
light brown



381603 Pull, three fingers
Antique brass

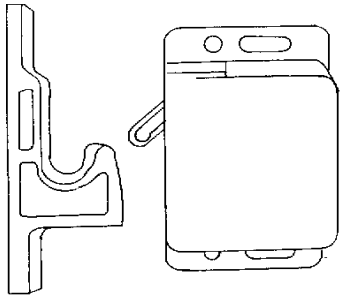

381228 Grabber door latch
w/catch,10 lb. Rating
381228-01 Gabber door latch
w/catch,3 lb. rating

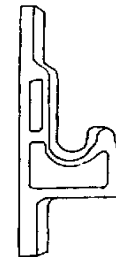

381228-100 Catch
only, grabber door latch

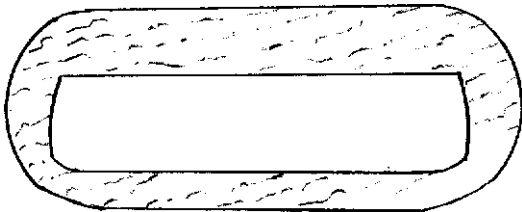

381175 Pull handle, wood

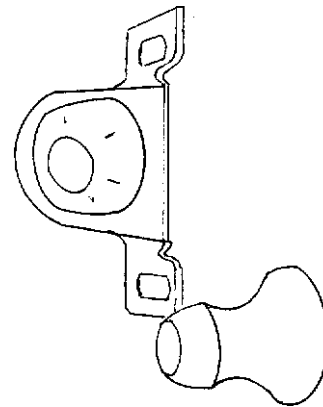

381074 Bulldog catch

2001 360XC DIESEL PUSHER

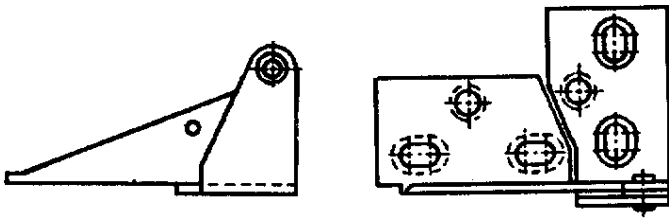

385935 Hinge, pivot, brass
for bath mirror

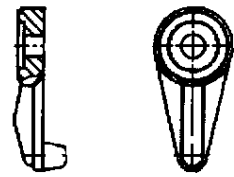

381612 Clip, mirror
retainer, brown

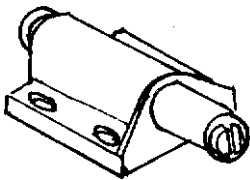

381653 Latch, single touch,
black



381655 Strike, for mirror
latch

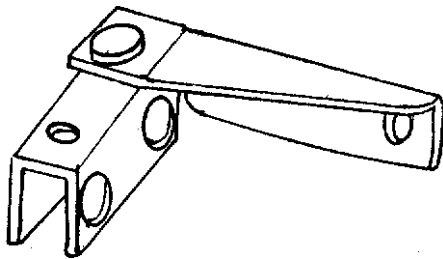

381654 Hinge, non-bore glass,
black

2001 360XC DIESEL PUSHER

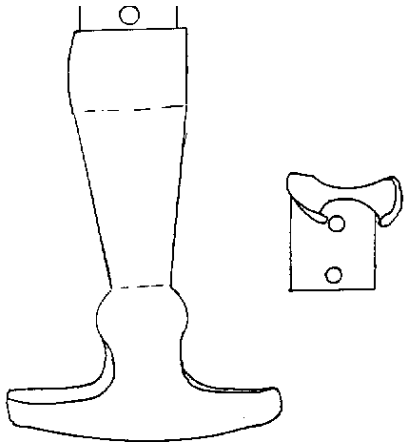

381021 Rubber T latch
w/ catch

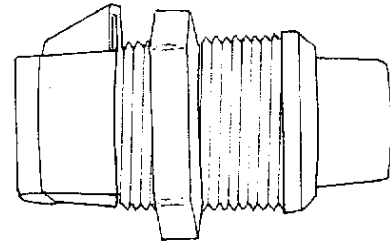

381408 Latch, push button
black, pantry

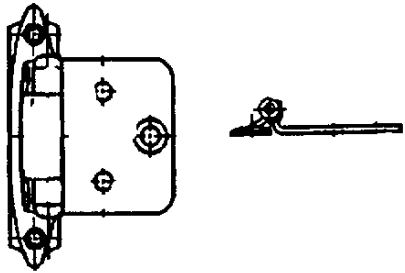

381601 Hinge, Antique brass

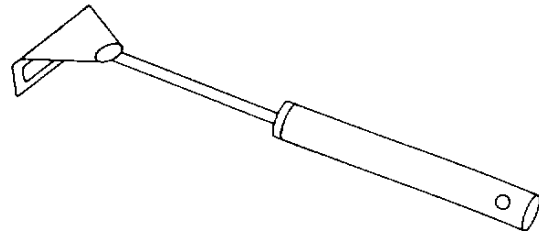

381147 Door support
spring loaded

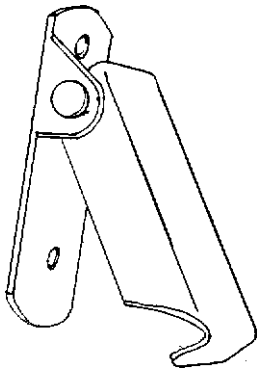

380509 Catch, holds engine
cover open, Bargman

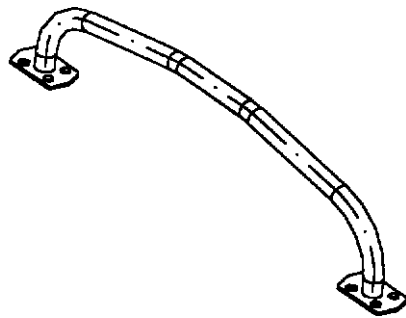

381736-02 Handle, dash accent

2001 360XC DIESEL PUSHER

Interior/ Window

381527	Speedy shelf strips
380045	Clothes rod
200975-04	Conduit, flexible, black plastic(covers rod)
380046	Clothes rod mounting bracket
381298	"J" bracket, center clothes rod support
340088	Retainer clip, medicine cabinet door mirrors
381612	Mirror clip, holds mirror in wood frame doors
381263	Bracket, prop w/ball, straight (rear bed top)
381262	Bracket, prop w/ball, angled
381549	Gas spring, SPD-GS-2300-150
381158	Lift handle, rear bed top
381530	Drawer latch, flexible black T handle
381626-02	Towel bar, chrome and brass
380248	Soap holder, chrome
380034	Toilet paper holder, chrome
380017	Holder, toothbrush and tumbler
381735	Latch, engine cover lid, interior
381735-01	Flange gasket for engine cover latch
203277	Insulator, sound, Bed liner
203277	Insulator, sound/heat, Engine cover

WINDOW, SE-GI CO.

371366-100	Weep hole cover, SE-GI window
371366-101	Sweep latch, SE-GI window

2001 360XC DIESEL PUSHER

SECTION IV L through Z

LABELS and TAGS	IV-1
OPTIONS	IV-3
PLUMBING	
LPG	IV-5
Fresh water.....	IV-6
Includes: Tank, fittings, faucets	
Drain	IV-12
Includes: Tanks, fittings, toilet	
SAFETY EQUIPMENT	IV-17
SEALS/SEALER/GASKETS	
Gaskets.....	IV-18
Window gaskets.....	IV-19
Sealer	IV-20
Adhesives, paint, under coat, stain	IV-21
UPHOLSTERY/FOAM/MATTRESS	
Mattress	IV-22
Sofa.....	IV-22
Chair.....	IV-22
Bed spread	IV-22
Pillow kits	IV-23
Dinette seat	IV-26
VENTS/FANS/SKY LIGHTS	IV-27
WOOD/INTERIOR TRIM.....	IV-28

2001 360XC DIESEL PUSHER

LABELS AND TAGS

385103	Plate, RVIA
385531	FMVSS certification label
385815	Name plate, motorhome hitch rating
385095	Tag registry #11999
385465	Label, exit warning (English)
385463	Label, warning label/cooking appliance
385464	Label, LP gas warning label (odor)
385788	Warning label, pilot light/refuel
385101	Tag, auxiliary tank dump valve handle
385099	Tag, black tank dump valve handle
385063	Label, drain cap
385062	Decal, 110-125 voltage AC
385309	Decal, fuel fill
385547	LP gas warning/fill label
385141	Tag, seat, clear w/black letters
385518	Label, dimension and clearance
385193	Label, 12Volt distribution inside
385560	Air conditioner rating label
385561	Generator rating label
385565	Label, holding tank flushing
385805-01	A/C priority switch label-front
385805-02	A/C priority switch label-rear
385812	Label, Calif. hazardous substance
385609	Label, smoke detector
385612	Label, parking brake warning
385829	Decal, fuse and relay
385828	Decal, fuse panel warning
385851	Label, cellular phone

(Continued)

2001 360XC DIESEL PUSHER

LABELS AND TAGS

385933	Label, name set relay
385941	Label, waste water holding
385942	Label, sewage holding tank
385943	Label, "cap must be in place"
385947	Label, 10-amp fuse maximum
385098	Label, seat occupancy
385608	Label, sewer hose
385829	Decal, fuse and relay
385828	Decal, fuse panel
385931	Decal sheet, utility compartment
385966	Label, inverter circuit
385988	Decal, water heater
385989	Decal, mirror heat
385946	Label, warning, slide out operation
381741	Key fob instructional plate

2001 360XC DIESEL PUSHER

OPTIONS

690413	VCR, Sony Hi-Fi
203153-01	Skylight, 22" x 22" clear
203152-03	Skylight trim out 22" x 22" x 4"
702804-02	Shade, pleated, 20.25" x 21.00"
690424	Washer/dryer, combo, vented
965042-02	Laundry cabinet assembly
690425-03	Refrigerator, 10CF, 2-way, RH, NDR1062, w/ice
801278-044	Refrigerator door insert, 54.88" x 16.69"
801278-034	Refrigerator door insert, 54.88" x 10.38"
690415	Kit, dairy, meat and ice cube tray
702679-xx	Awning, front door, 4' (see awnings page II-13)
702679-27	Hardware, awning, front bus door
702679-20	Air foil kit, 4' Dometic awning
963421-03	Table assembly, free standing dinette
703009-03	Chair, dinette, folding, oak
690323-29	Air conditioner, 1500 Briskair, w/heat pump
690323-26	Electronic kit, Briskair
690380-02	Heat strip
690380-04	Thermostat
690380-08	Remote sensor
690323-12	Cover, return air, Polar White

2001 360XC DIESEL PUSHER

OPTIONS

702967-02	Buddy seat, passenger w/footrest & Vibrasonic
702897-07	Seat, passenger, w/footrest & Vibrasonic
511503	Kit, Vibrasonic seat
703047	Recliner, Avant glide w/ottoman
511511-01	Mirror, cab, exterior, chrome, RS
511511-02	Mirror cab, exterior, chrome, CS
690396-01	Range w/oven, Magic Chef
203253	Rear mud flap, 16 x 93", rubber only
110723	Rear mud flap, S.S. lettering only
453797	Bracket, hanger, rear mud flap

2001 360XC DIESEL PUSHER

PLUMBING

LPG

601500	LP tank, 105lbs. w/90ohm sender
511229	Sending unit, 90 ohm, Snap-on
601277	Regulator, LP gas, 2-stage, Marshall Brass
201649	Access cover, LP regulator
601673-01	LP hose, 3/8" x 48", low pressure.
601527-02	LP hose, high-pressure liquid, 51in.
601769	Tee, brass 1/2" x 3/8FM x 3/8FM
600004	Tubing, copper, 5/8in.
600008	Tubing, copper, 3/8in.
600435	Flare nuts, forged, 3/8in.

2001 360XC DIESEL PUSHER

PLUMBING FRESH WATER

601756	Tank, fresh water, 71 gallon
600139	Check valve, brass
601061-03	Water pump, Shurflo
600668	Filter, pre-water pump
601766	Water fill, gravity type, freshwater
601763	Valve, water heater by-pass
601764	City water hook-up/tank fill

FITTINGS

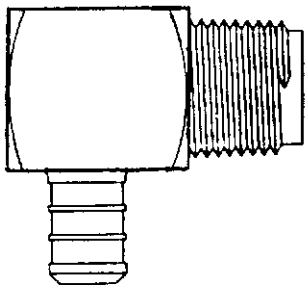

601698-04
Elbow, 1/2" barb
x 1/2" MPT

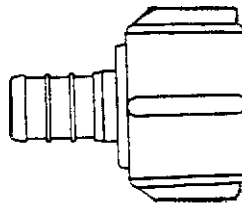

601698-03
Coupler, 1/2" barb
x 1/2" FPT

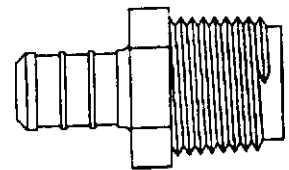

601698-02
Coupler, 1/2" barb
x 1/2" MPT

(Continued)

2001 360XC DIESEL PUSHER

PLUMBING FRESH WATER-FITTINGS

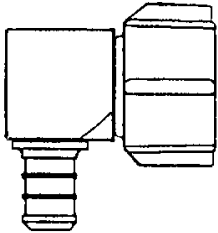

601698-05
Elbow 1/2" barb x
1/2" FPT

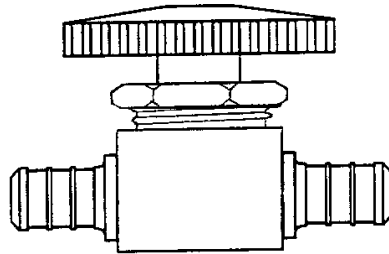

601698-07
Shut-off, 1/2" barb x
1/2" barb

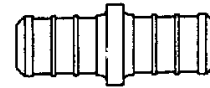

601698-08
Coupler
1/2" x 1/2" barb

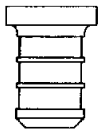

601698-09
Plug, 1/2" barb

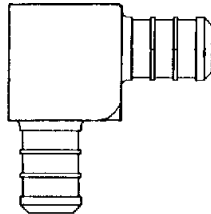

601698-10
Elbow 1/2" barb x
1/2" barb

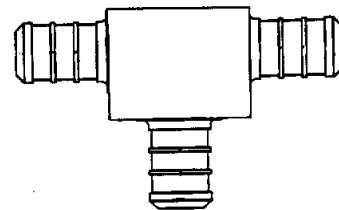

601698-11
Tee, 1/2" x 1/2" x
1/2" barb



601698-15
Crimp ring, 1/2"
E-Pex, 1/2" (black)



601698-01
E-Pex tube, 1/2"

(Continued)

2001 360XC DIESEL PUSHER

PLUMBING FRESH WATER-FITTINGS



601698-16
Crimp ring, 3/4"
E-Pex, black



601698-12
E-Pex tube, 3/4"

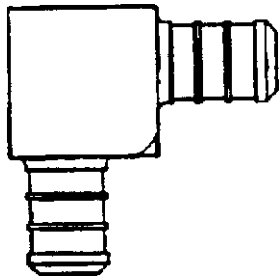

601698-13
Elbow, 3/4" x 3/4" barb

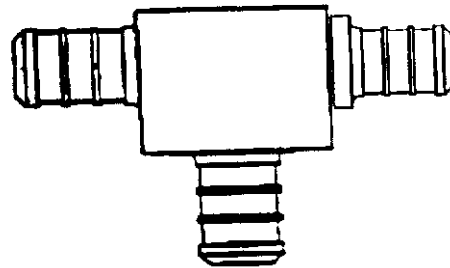

601698-18
Tee, 3/4" x 1/2" x 3/4" barb

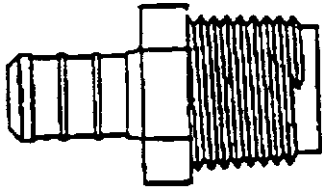

601698-19 Coupler, 3/4" barb x 3/4" MPT

2001 360XC DIESEL PUSHER

PLUMBING

601771 Moen Pure Touch Classic

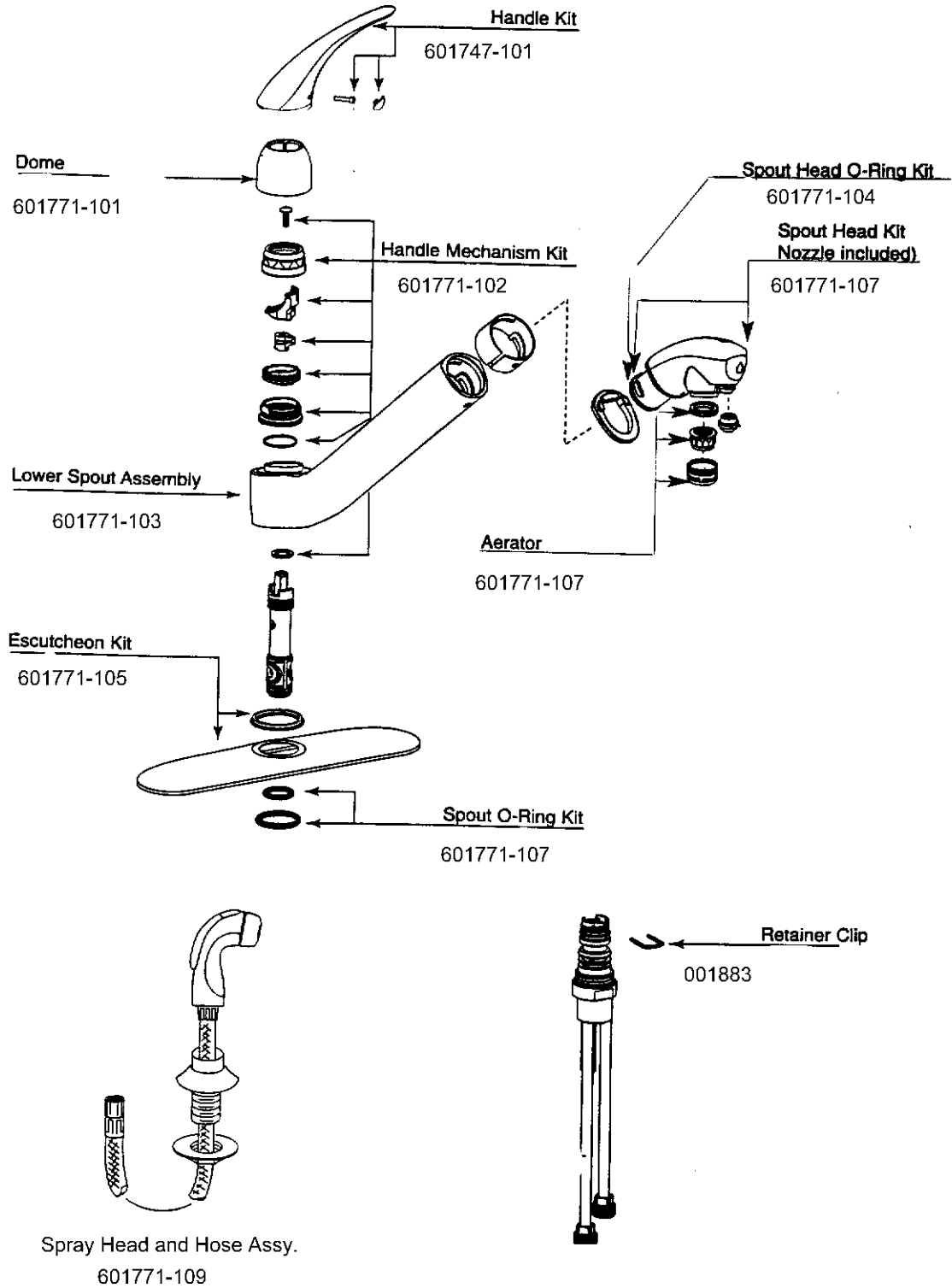

2001 360XC DIESEL PUSHER

PLUMBING FRESH WATER-FAUCETS

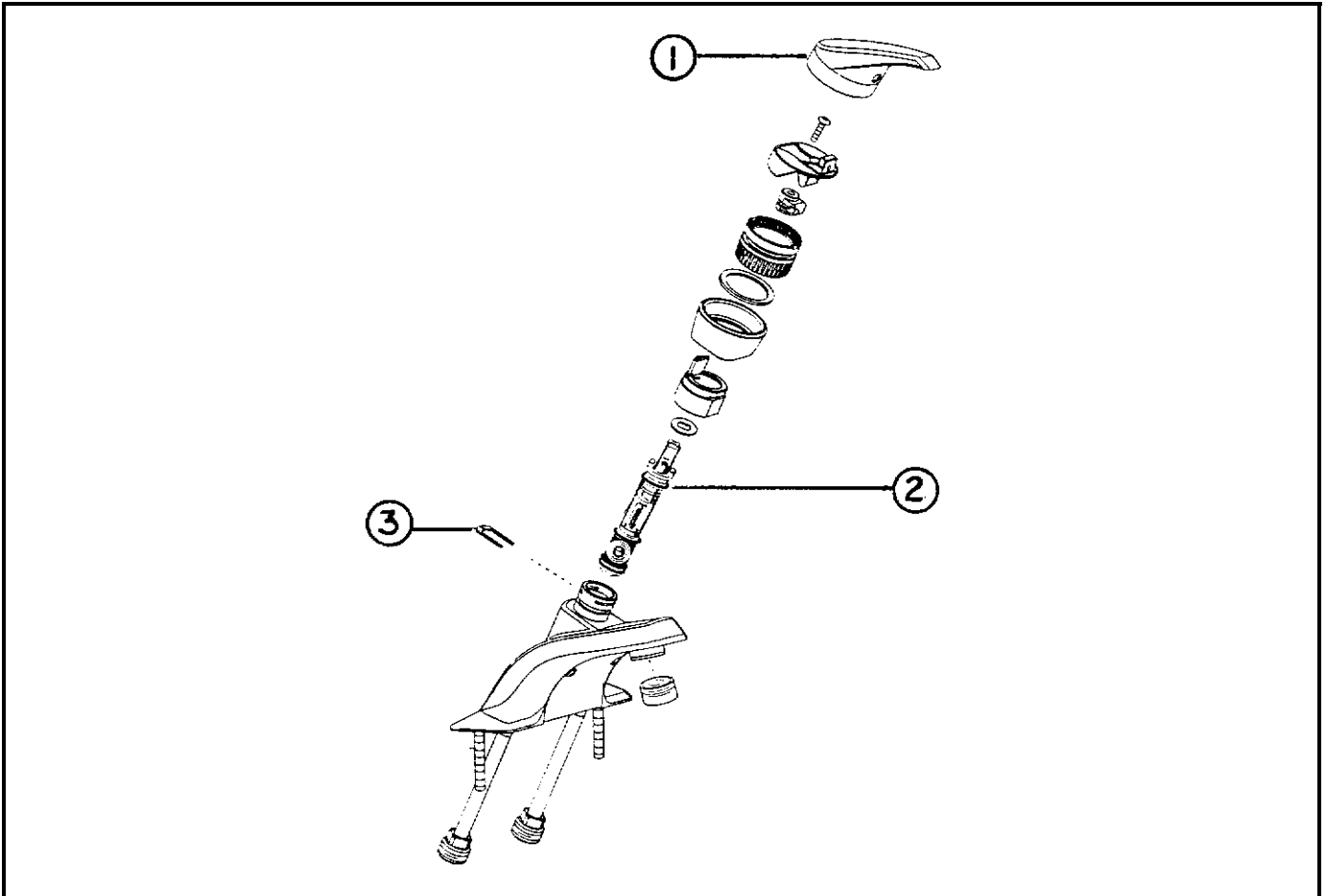

690390-02 Faucet, lavatory, Moen, brass/chrome

- 1) 690390-100 Lever handle
- 2) 601579-105 Cartridge
- 3) 601579-104 Retainer clip

2001 360XC DIESEL PUSHER

PLUMBING FRESH WATER-FAUCETS

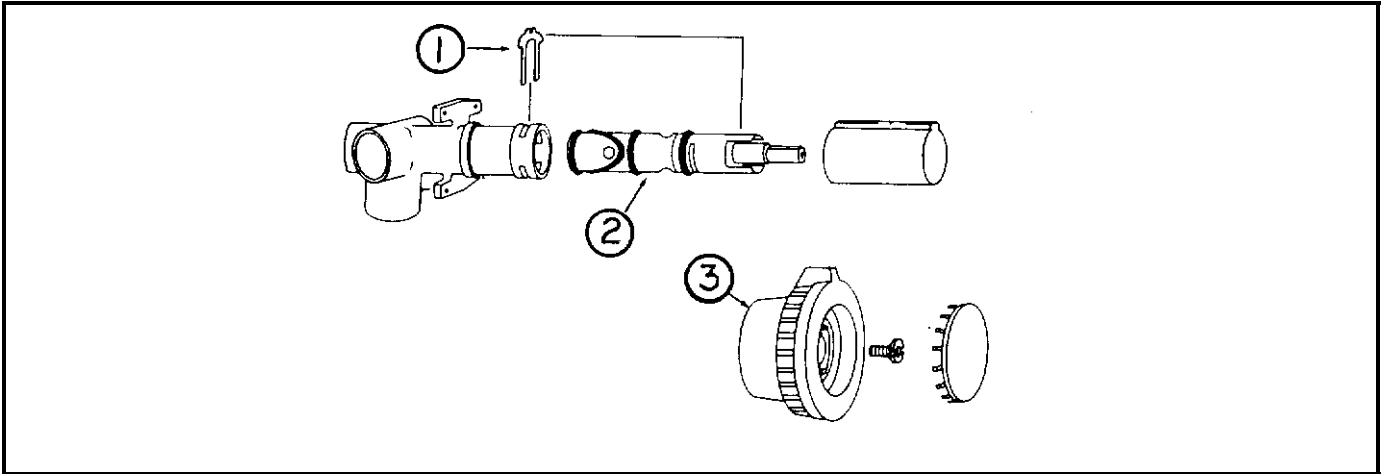

601420-02 Faucet, shower

- 1) 000883 Retainer clip
- 2) 601420-100 Cartridge
- 3) 001041 Handle

- 601358-100 Shower head, chrome
- 600330 Shower hose, chrome
- 600332 Vacuum breaker, chrome

2001 360XC DIESEL PUSHER

PLUMBING DRAIN SYSTEM

601755-02	Holding tank, gray
601755-01	Holding tank, black
601441	Tank flush, no-fuss (vacuum breaker and check valve)
601441-01	Nozzle, tank mounted, no-fuss flush
601197-01	Water hook-up, chrome, black tank flush
601482	Dump valve assembly

FITTING-BELOW FLOOR

195329-229	Reducer adapter, 3" to 1.5"
601251	Adapter.3" termination
0310107	Waste valve adapter
600820	3" Single socket, 90 degree
601160-02	Pipe, ABS, 1.5"
601160-04	Pipe, ABS, 3.0"
601607-06	Bayonet ring, glue on, 3"
601607-07	Bayonet cap, 3"
600224	Elbow, 3", 45 degree, long street

2001 360XC DIESEL PUSHER

PLUMBING DRAIN SYSTEM-ABOVE FLOOR

601266	Closet flange, 3" x 4", slip fit, tank to toilet adapter
201999	Shower stall, almond
601362-02	Drain, polished chrome
600594	Strainer w/rubber stopper
203037	Shower/tub, fiberglass-35 non slide
601362-02	Drain, polished chrome
600594	Strainer w/rubber stopper
203286	Lavy bowl, Karran
601767-02	Tail piece assy, chrome
601663-06	Sink, galley, porcelain, Almond
600968	Sink strainer
601700	Hose, drain, Kaf-Flex 1.5, galley slide out
964233	Plumbing support, galley slide out

FITTINGS, 1.5" PLASTIC

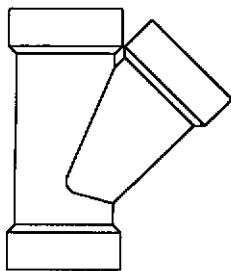

**WYE
#2301
600094**

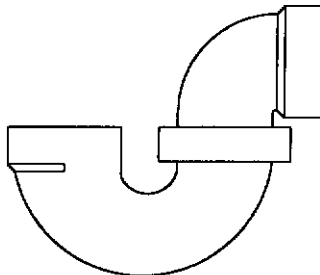

**P-TRAP
1.5" W/O SLIP NUT
600144**

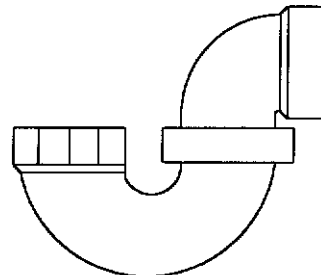

**P-TRAP
1.5" WITH SLIP NUT
600622**

(Continued)

2001 360XC DIESEL PUSHER

PLUMBING FITTINGS, 1.5" PLASTIC

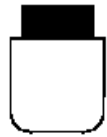

VENT 1.5"
600338



PLUG 1.5"
600155



CAP 1.5"
601877

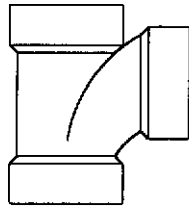

TEE-SANITARY
1.5"
600156

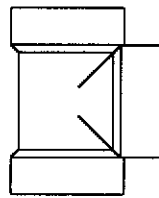

TEE-BI DIRECTIONAL
CLEAN-OUT 1.5"
601318

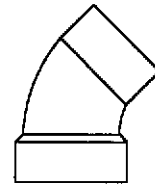

ELBOW 45D
LONG ST
600027

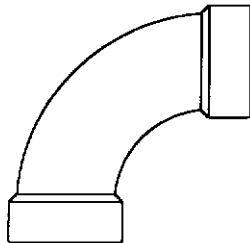

ELBOW 90D
LONG TURN
600035

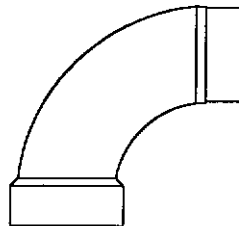

ELBOW 90D
LONG ST
600431

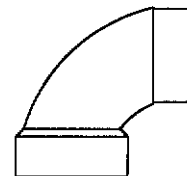

ELBOW 90D
SHORT ST
600662

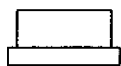

REDUCER 1.5" TO 1.25"
601263

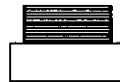

ADAPTER
601676



ADAPTER
W/FEMALE THREADS
600308

(continued)

2001 360XC DIESEL PUSHER

PLUMBING

FITTINGS, 1.5" PLASTIC

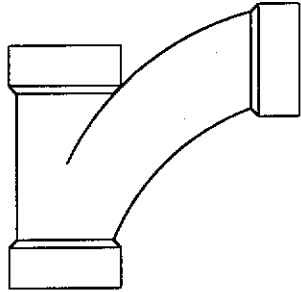

**WYE 1.5"
1/8" BEND
600182**

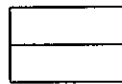

**COUPLING
1.5"
600227**

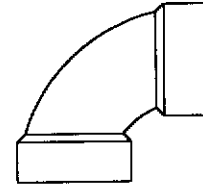

**ELBOW 90D
SHORT SWEEP
601636**

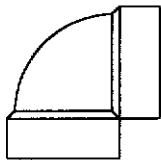

**ELBOW VENT
90D
600033**

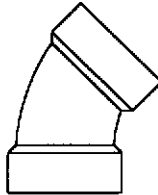

**ELBOW 45D
LONG TURN
600030**

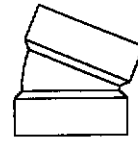

**ELBOW 22.5D
SHORT TURN
600116**

2001 360XC DIESEL PUSHER

PLUMBING

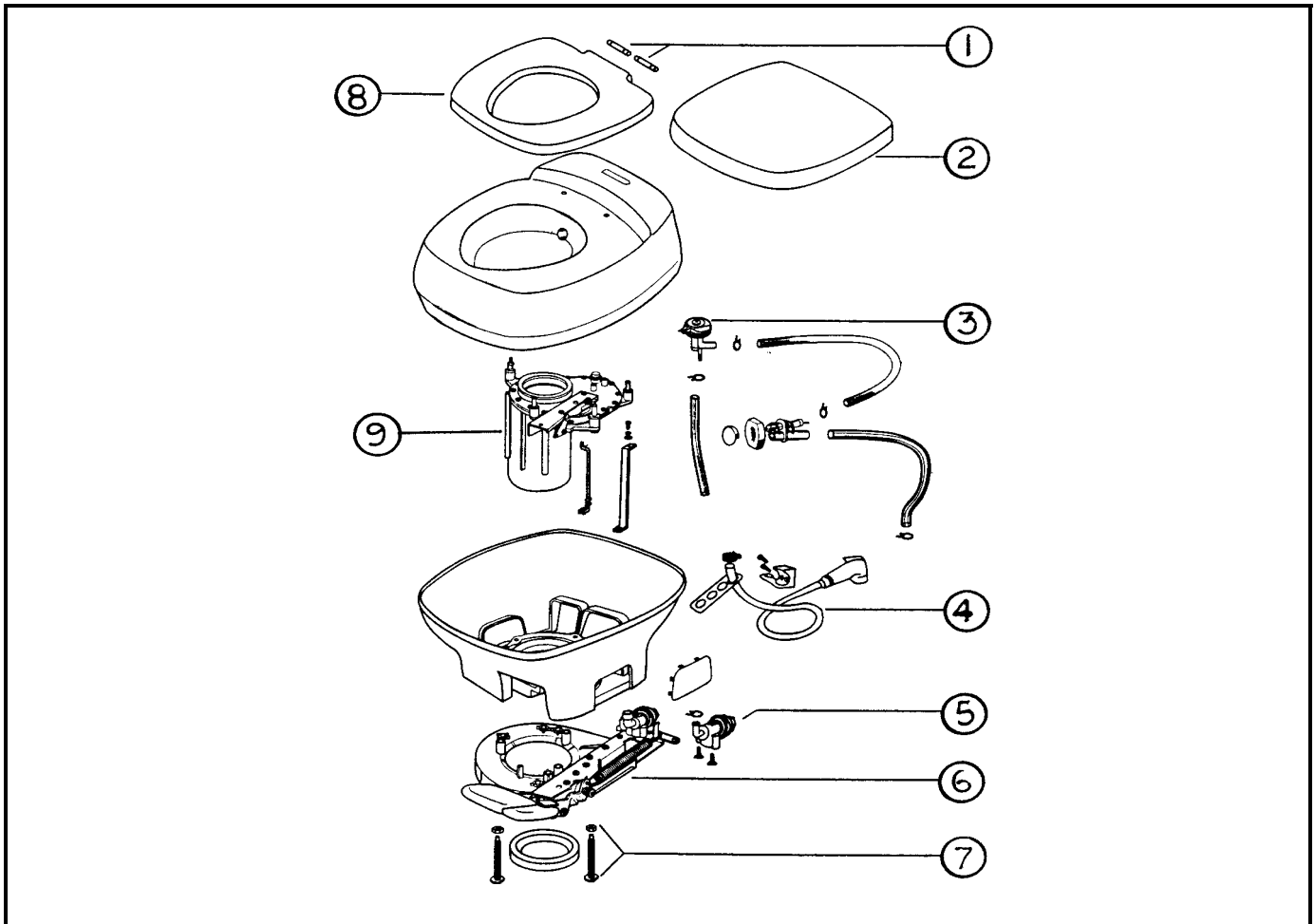

690386 Toilet, Thetford China, Aurora, bone

- | | |
|---------------|--|
| 1) 690386-101 | Hinge pins, seat, Aurora |
| 2) 690386-102 | Seat cover, bone, Aurora |
| 3) 690386-103 | Vacuum-breaker, Aurora |
| 4) 690386-104 | Hand spray kit, Aurora |
| 5) 690386-105 | Ball valve kit, Aurora |
| 6) 690386-106 | Lower mechanism assembly, bone, Aurora |
| 7) 690386-107 | Closet flange seal & bolt kit |
| 8) 690386-108 | Seat, bone, Aurora |
| 9) 690386-109 | Upper mechanism assembly, bone, Aurora |

2001 360XC DIESEL PUSHER

SAFETY EQUIPMENT

510781	Detector, smoke #1056 w/silencer
511343	Detector, carbon monoxide-9 volt
511309	Detector, LPG
510734	Alarm, back-up
381069	Seat belt kit, cocktail chair
690381-01	Fire extinguisher 10 B: C UL
690381-02	Fire extinguisher 10 B: C ULC (Canadian)
380188	Emergency warning triangle set of 3

2001 360XC DIESEL PUSHER

SEALER, GASKETS, PAINT, ADHESIVES GASKETS



1) 365205



2) 365237-01



3) 365232



4) 365214



5) 201260



6) 381524



7) 381665



8) 365013-01

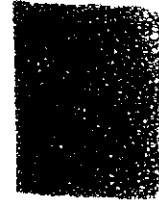

9) 365009

1) 365005

Gasket, weather strip, rear trunk door

2) 365237-01

Seal, dust, compartment door edge

3) 365232

Seal, main door/compartment door jamb

4) 365214

Gasket, seal-compartment door hinge and main door jamb

5) 201260

Insert, windshield gasket, rubber

6) 381524

Gasket, windshield, includes center strip

7) 381665

Gasket, window to body, door jamb

8) 365013-01

Gasket, screen door, low-density foam

9) 365009

Gasket, screen door, at bottom notch

2001 360XC DIESEL PUSHER

Sealer, gaskets, paint, adhesives

GASKETS-SE-GI WINDOWS



1) 371366-103



2) 371366-102



3) 371366-104



4) 371366-105

- | | |
|---------------|--------------------------------|
| 1) 371366-103 | Track, window screen, Se-Gi |
| 2) 371366-102 | Track, sliding pane, Se-Gi |
| 3) 371366-104 | Wiper seal, vertical, Se-Gi |
| 4) 371366-105 | Screw cover, clamp ring, Se-Gi |

Not shown:

365263 Gasket, engine cover

2001 360XC DIESEL PUSHER

SEALER, GASKETS, PAINT, ADHESIVES

SEALER

360002	Vulkem sealer, gray
360052	Vulkem sealer, black
360180	Sika flex #221
360268-01	Liqua-Seal, roof, white
360255-03	Sealer, anti-wick
360176	Sealant, Almond, bathroom
360210	Sealant, Paralastic #4334-04 (refrigerator compartment sealer)
360283	Silicone sealer, Corian bone

2001 360XC DIESEL PUSHER

SEALER,GASKETS, PAINT,ADHESIVES

ADHESIVES

702791	Border adhesive
800639-02	Adhesive, Oak plank flooring
360270	Adhesive spray, Sta-Put, ceiling panels (reference only, not available for shipment)
360261	Glue, urethane

PAINT

Each vehicle has been provided with a sheet listing the paint color codes on that particular motorhome .Also, each motorhome is shipped with touch-up paint for each color.

A back up color chart for each motorhome is kept in Airstream's files .If calling Airstream for this information ask for "Sales" and have the serial number available for them.

360292	Stain, Saratoga Oak (new for year 2000)
365244	Lacquer, clear, used on wood

MISCELLANEOUS

360179	Undercoat, Pennzoil II
6000329	Tape,silver,2" wide
200518	Spline, gray, screen insert
380079	Screen, gray

2001 360XC DIESEL PUSHER

UPHOLSTERY/FOAM/MATTRESS

702987 Mattress,60" x 80" w/45 degree corner

701611 Pillow 21" x 31"

*702677-399 Bedspread ,Roman Sands

963096 Head board,62"wide

702901-01 Swivel chair, Villa

*702899-399 Sofa, jack knife, 74",Villa,Roman Sands

702897-01 Seat, driver, power w/belts

702898-01 Seat, passenger, non-power, w/belts

998070 Cover, seat, side dinette

998071 Cover, back, side dinette

*Changing the-(dash) number to:

350 = Georgia Peach

320 = Golden Oak

470 = Mandalay Blue

379 = Mosaic Blue

460 = Mystic Mint

2001 360XC DIESEL PUSHER
 UPHOLSTERY/FOAM/MATTRESS

PILLOW KIT ROMAN SANDS

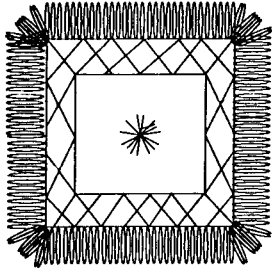

703032-01 Lounge accent pillow

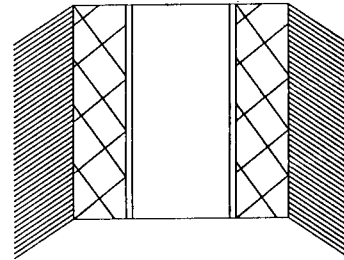

703032-02 Lounge accent pillow

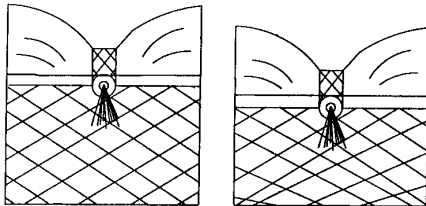

703032-03 Lounge accent pillows
 703032-04(chair)

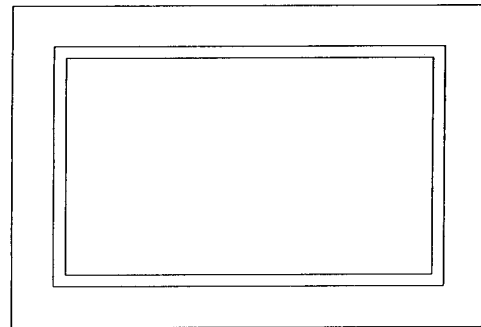

703032-05 Sham, Queen

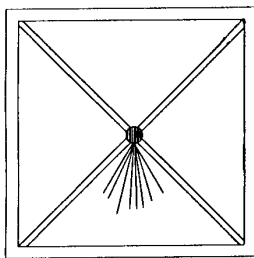

703032-06 Bedroom accent pillow

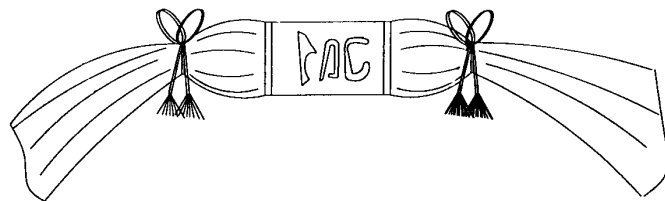

703032-07 Bedroom accent pillow

2001 360XC DIESEL PUSHER
UPHOLSTERY/FOAM/MATTRESS

PILLOW KIT-MOSAIC BLUE

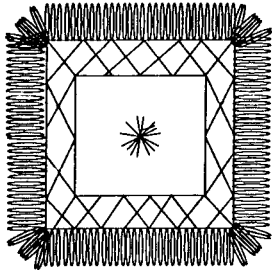

703033-01 Lounge
accent pillow

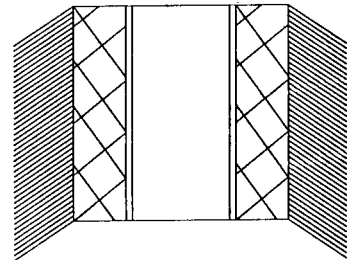

703033-02 Lounge
accent pillow

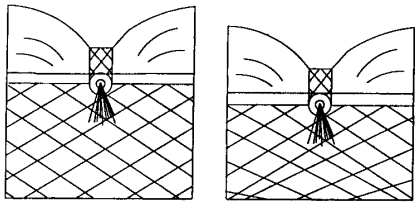

703033-03 703033-04 (chair)
Lounge accent pillows

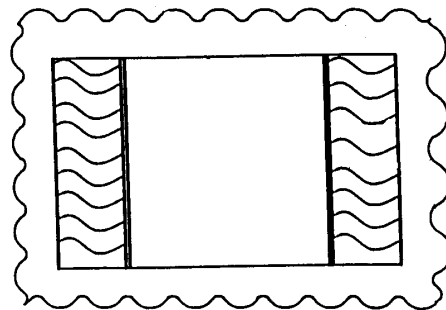

703033-05 Sham, Queen

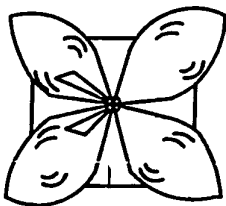

703033-06 Bedroom
accent pillow

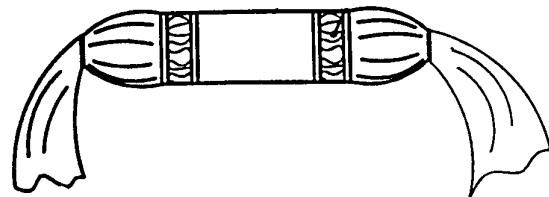

703033-07 Bedroom accent pillow

2001 360XC DIESEL PUSHER

Upholstery/Foam/Mattresses Golden Oak pillow kit

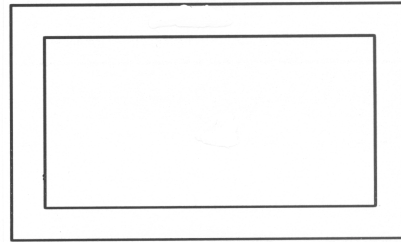
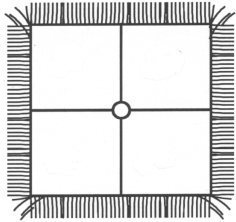

703089-01 Sofa Pillow

703089-02 Bedroom Sham

Georgia Peach Pillow Kit

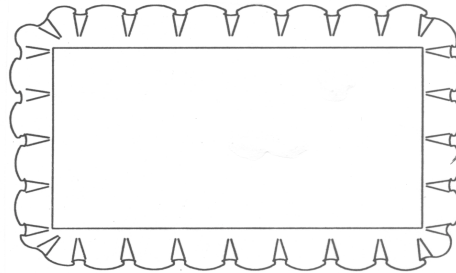
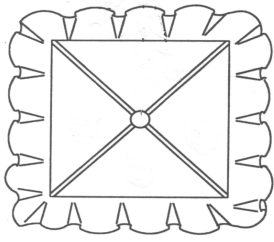

Mandalay Blue

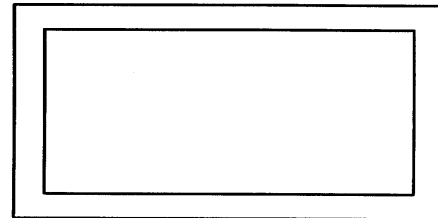
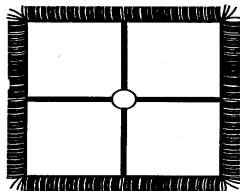

703107-01
Sofa Pillow

702107-02
Bed Pillow Shams

Mystic Mint

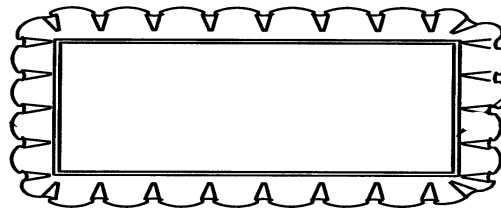
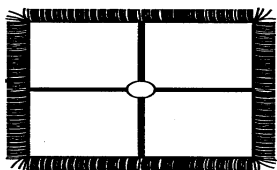

703109-01
Sofa Pillow

703109-02
Bedroom pillow shams

2001 360XC DIESEL PUSHER

UPHOLSTERY/FOAM/MATTRESS

964500	Upholstered back, aft dinette
702464-19	Foam, dinette, upper back, RH
702464-07	Foam, dinette, lower back
964501	Upholstered back, forward dinette
702464-20	Foam, dinette, upper back, LH
702464-07	Foam, dinette, lower back
998070	Cover, seat, side dinette
702464-09	Foam, dinette, aft seat
702464-11	Foam, dinette, forward seat
998071	Cover, back, side dinette
965234-01	Shadow Box assy., lounge/dinette, C/S
965234-02	Shadow box assy, Lounge, R/S
965234-03	Shadow Box assy, Bedroom

2001 360XC DIESEL PUSHER

VENTS/FANS

381207-02	Vent w/screen, refrigerator, roof
511152-11	Range exhaust, w/monitor
511152-01	Vent cover, exterior, range exhaust
114982	Transition box. range exhaust
203148-01	Skylight, heavy duty, 14.5" x 22.5"
203148-02	Trim dome, inner, skylight, 14" x 22"
381541-06	Roof vent w/power lift
381541-02	Switch, roof vent
381541-04	Trim ring, ceiling vent, Birch
690266-03	Garnish, 4" extension
381450	Vent, roof, Fantastic#6000RBT
511547	Fan, defrost, chrome
381631-01	Skylight, plastic, neo-angle 22" x 22"
203152-06	Garnish, skylight, 13.25" x 21" x 4 in., white

2001 360XC DIESEL PUSHER

WOOD/INTERIOR TRIM

801261-01	Paneling, interior wall, 1/8" x 4' x 8', Antiquity Buff
203159-02	Trim, divider bar, interior panels, Antiquity Buff
800507-01	Paneling, luan, 1/8" x 4' x 8'
800397-01	Cedar, planked, 5/32" x 4' x 8'
201728-01	Extrusion, ceiling trim retainer
201728-04	Extrusion, ceiling trim
801283	Paneling 1/2" x 4' x 8', G2S, Antiquity Buff
801274	Paneling 1/2" x 4' x 8', G1S, Antiquity Buff
801180-004	Paneling 1/2" x 4' x 7', G2S, Oak/oak
801179-004	Paneling, 1/2" x 4' x 7', G1S, Oak/raw
801182-004	Paneling 5/32" x 4' x 7', G2S, Oak/Oak
801181-004	Paneling 5/32" x 4' x 7', G1S, Oak/raw
801229	Laminate, oak, 4' x 8'
365251-01	Tape, seam, Antiquity Buff, 1 1/8" wide
365251-02	Tape, seam, Antiquity Buff, 8" wide
365251-03	Tape, seam, Antiquity Buff, 12" wide

2001 360XC DIESEL PUSHER

WOOD/INTERIOR



1) 801206-014



2) 964152-014

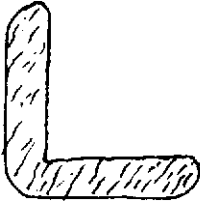

3) 801175-04



4) 800571-014



5) 800617-014



6) 801172-014
6a) 801172-04



7) 801173-034



8) 801173-044

- | | |
|--------------|--|
| 1)801206-014 | Molding, floor, Oak, 43" |
| 2)964152-014 | Molding, chair rail, Oak |
| 3)801175-04 | Molding, corner, Antiquity Buff |
| 4)800571-014 | Molding, Oak, flat 1/4" x 33/64" x 80" |
| 5)800617-014 | Molding, Wainscoat, Oak |
| 6)801172-014 | Molding, flexible corner, Oak |
| 6a)801172-04 | Molding, flexible corner, Antiquity Buff |
| 7)801173-034 | Molding, flat radius, .88" Oak |
| 8)801173-044 | Molding, flat radius, 1.13" Oak |

(Trim continued)

2001 360XC DIESEL PUSHER

WOOD/INTERIOR TRIM

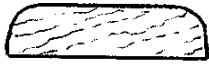

1) 800573-014



2) 800572-014



3) 201728-03

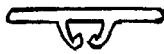

4) 201728-01



5) 203159-02

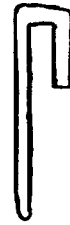

6) 201666-01

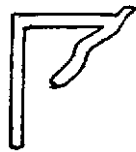

7) 201790-01



8) 203138-03

8a) 203138-02

1) 800573-014

Molding, door edge, Oak, 13/32" x 80"

2) 800572-014

Molding, panel edge, Oak 23/32" x 80"

3) 201728-03

Extrusion, ceiling trim, beige

4) 201728-01

Extrusion, ceiling trim retainer

5) 203159-02

Trim, divider bar, interior panels, Antiquity Buff

6) 201666-01

Molding, J, 3/16, plastic, Almond

7) 201790-01

Molding, cove, white, ceiling to wall

8) 203138-03

Extrusion, wall, plastic, beige (panel edging)

8a) 203138-02

Extrusion, wall, plastic, brown (panel edging)

2001 360XC DIESEL PUSHER

WOOD/INTERIOR TRIM

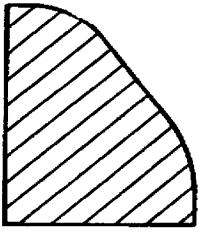

1) 800576-014

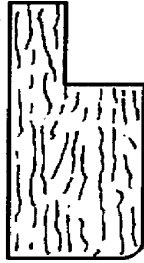

2) 801189

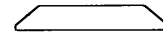

3) 801178-03

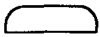

4) 801173-014

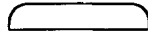

5) 801173-024

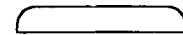

6) 801173-034

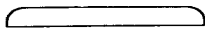

7) 801173-044

1)800576-014	Molding, bath doorstep, Oak
2)801189	Trim, bath doorjamb, Oak
3)801178-03	Flat molding, vinyl wrapped, Antiquity Buff
4)801173-014	Flat molding, vinyl wrapped, Oak, .50 wide
5)801173-024	Flat molding, vinyl wrapped, Oak, .75 wide
6)801173-034	Flat molding, vinyl wrapped, Oak, .88 wide
7)801173-044	Flat molding, vinyl wrapped, Oak, 1.13 wide

SLIDE OUT ROOM INTERIOR TRIM

964267-004	Molding, decorative Oak, slide out trim, 84"
964267-014	Molding, decorative Oak, slide out trim, 120"
964101-024	Facia, decorative Oak, corner block, slide out

2001 360XC DIESEL PUSHER

WOOD/INTERIOR TRIM



1) 801289

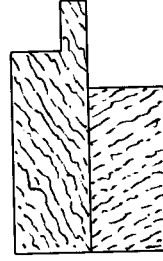

2) 801290

- 1)801289
- 2)801290

- Trim, step, entrance
- Trim w/ledge, step, entrance