

***AIRSTREAM***

**35'**  
**XC Pusher**

**2000**  
**Parts Book**

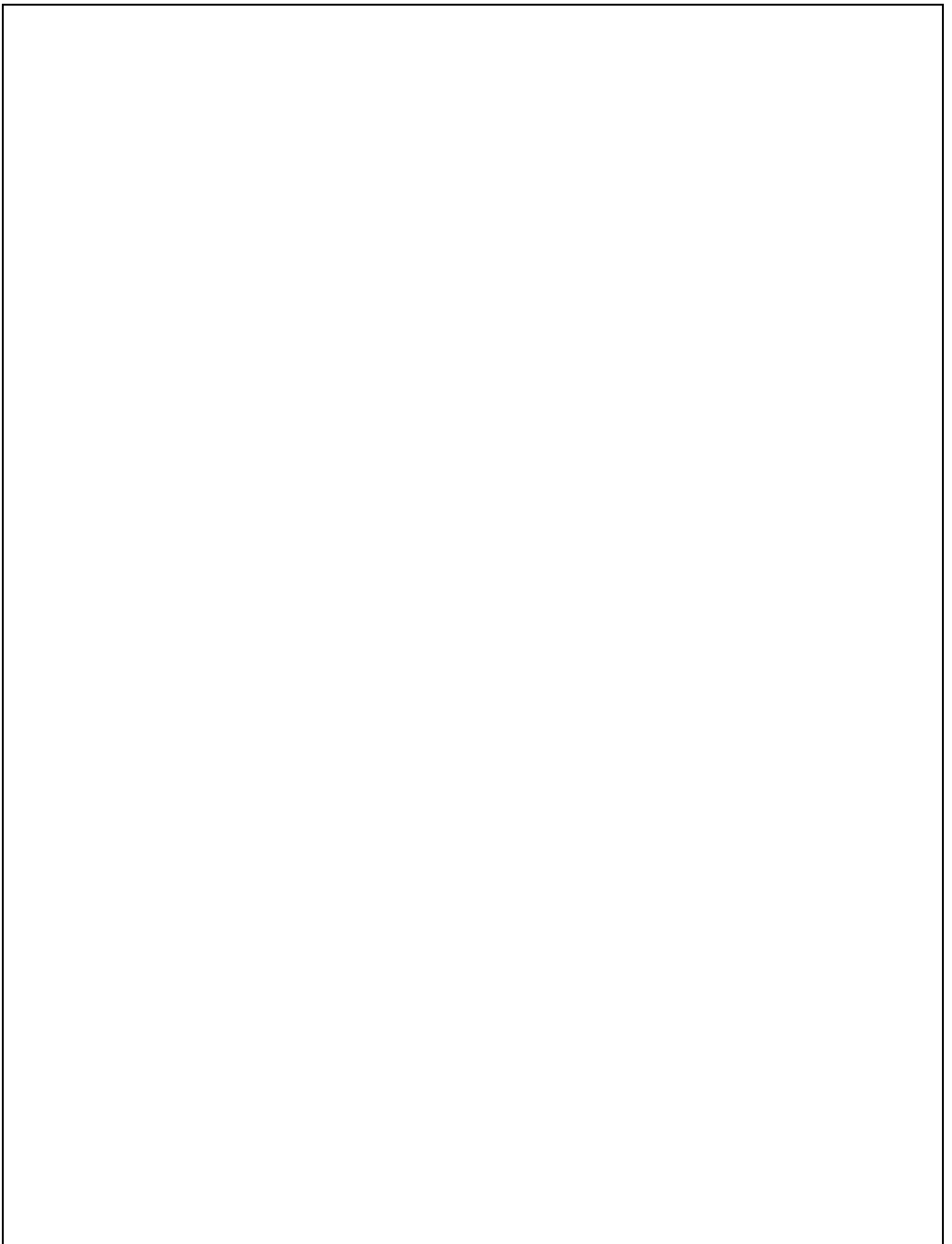

TABLE OF CONTENTS  
2000 LAND YACHT XC 35FT.PUSHER

SECTION I  
A through C

APPLIANCES

<a href="#">Air conditioner</a> .....	I-1
<a href="#">Furnace</a> .....	I-1
<a href="#">Micro-wave</a> .....	I-1
<a href="#">Range</a> .....	I-2
<a href="#">Refrigerator</a> .....	I-2
<a href="#">Water heater</a> .....	I-3

BODY

<a href="#">CS wall, <b>slide out</b></a> .....	I-5
<a href="#">RS wall, <b>slide out</b></a> .....	I-7
<a href="#">Slide out extrusions</a> .....	I-8
<a href="#">Slide out gaskets</a> .....	I-9
<a href="#">Front end</a> .....	I-11
<a href="#">Aft end</a> .....	I-13
<a href="#">Roof</a> .....	I-14

CHASSIS

<a href="#">Hitch</a> .....	I-15
<a href="#">Power jacks</a> .....	I-15
<a href="#">Step</a> .....	I-15
<a href="#">Exhaust extension</a> .....	I-15
<a href="#">Automotive air conditioner</a> .....	I-16

# TABLE OF CONTENTS

## 2000 LAND YACHT XC 35FT.PUSHER

### SECTION II

#### D through E

##### DASH

[Dash parts](#) ..... II-2

[DECALS](#) (reference) ..... II-3

##### DOORS/WINDOWS/AWNINGS

[RS, slide out](#) ..... II-6

[CS, slide out](#) ..... II-8

[Main & Screen door](#) ..... II-10

[Awning chart](#) ..... II-11

[DRAPES/SHADES/VALANCES](#)..... II-12

##### ELECTRICAL

[110 volt](#) ..... II-13

[12-volt, chassis](#) ..... II-16

[Dash switches/lens](#) ..... II-17

[12-volt interior switches](#) ..... II-18

[12-volt interior lights](#) ..... II-21

[12-volt exterior lights](#) ..... II-20

[12-volt mics](#) ..... II-26

[Windshield wiper assy.](#) ..... II-24

##### ENTERTAINMENT

[Televisions](#) ..... II-27

[Radios](#) ..... II-27

[Rear view monitor](#) ..... II-28

**TABLE OF CONTENTS**  
**2000 LAND YACHT XC 35FT.PUSHER**  
**SECTION III**  
**F through H**

FASTENERS (common fasteners available locally are  
not listed)

<a href="#">Rivets</a> .....	III-1
<a href="#">Screws</a> .....	III-3

**FLOOR COVERING**

<a href="#">Carpet</a> .....	III-4
<a href="#">Tile</a> .....	III-4
<a href="#">Mats</a> .....	III-4

**FURNITURE**

<a href="#">Interior doors</a> .....	III-5
<a href="#">Mirrors</a> .....	III-6
<a href="#">Drawer face</a> .....	III-7
<a href="#">Drawer box</a> .....	III-7
<a href="#">Bedroom furniture</a> .....	III-8
<a href="#">Bath, slide out</a> .....	III-9
<a href="#">Galley, slide out</a> .....	III-10
<a href="#">Lounge, slide out</a> .....	III-12
<a href="#">Cab</a> .....	III-13

**HARDWARE**

<a href="#">Exterior locks</a> .....	III-14
<a href="#">Main door/screen door</a> .....	III-15
<a href="#">Exterior access doors</a> .....	III-17
<a href="#">Front hood</a> .....	III-18
<a href="#">Slide out room</a> .....	III-19
<a href="#">Awning hardware</a> .....	III-21
<a href="#">Interior hardware</a> .....	III-22

# TABLE OF CONTENTS

## 2000 LAND YACHT XC 35FT.PUSHER

### SECTION IV L through Z

[LABELS and TAGS](#) .....IV-1

[OPTIONS](#) .....IV-3

### PLUMBING

[LPG](#) .....IV-5

[Utility compartment](#) .....IV-6

[Fresh water](#) .....IV-7

[Faucets](#) .....IV-10

[Drain water](#) .....IV-14

[Toilet](#) .....IV-18

[SAFETY EQUIPMENT](#) .....IV-19

### SEALS/SEALER/PAINT

[Gaskets](#) .....IV-20

[Sealer](#) .....IV-22

[Adhesive](#) .....IV-23

[Paint](#) .....IV-23

[UPHOLSTERY/FOAM/MATTRESS](#) .....IV-24

[VENTS/FANS](#) .....IV-32

[WOOD/INTERIOR TRIM](#) .....IV-33

**TABLE OF CONTENTS**  
**2000 LAND YACHT XC 35FT.PUSHER**

SECTION I  
A through C

APPLIANCES

Air conditioner .....	I-1
Furnace .....	I-1
Micro-wave.....	I-1
Range.....	I-2
Refrigerator .....	I-2
Water heater .....	I-3

BODY

CS wall, <b>slide out</b> .....	I-5
RS wall, <b>slide out</b> .....	I-7
Slide out extrusions .....	I-8
Slide out gaskets.....	I-9
Front end .....	I-11
Aft end .....	I-13
Roof .....	I-14

CHASSIS

Hitch .....	I-15
Power jacks .....	I-15
Step .....	I-15
Exhaust extension .....	I-15
Automotive air conditioner .....	I-16





# 2000 LAND YACHT XC 35FT.PUSHER

## APPLIANCES

### DUO THERM AIR CONDITIONER-PENQUIN

690380-02	Air conditioner, Penquin 13, 500 BTU
690323-26	Electronic kit, Penquin
690380-04	Thermostat, Duo Therm
690323-100	Shroud, exterior, Penquin
385582-01	Decal, Airstream w/bar, gray
203069	Register, white, 4" x 8"
690323-12	Cover, return grill

### FURNACE, HYDROFLAME (800-825-4328) -dealer only

690274	Furnace, Hydroflame, #8535-IV, 34000BTU
690244-06	Mounting flange
690274-06	Door exterior, Hydroflame
601244-03	Register.rotaire, black
600969-01	Grille, 6x4, col. white
600247	4" duct hose, flexible

### MICROWAVE

690345-01	Microwave/convection oven, Sharp
690345-03	Trim ring, microwave mounting

# 2000 LAND YACHT XC 35FT.PUSHER

## APPLIANCES

### RANGE

690396-02 Range top, 3-burner, Maytag  
690396-02 Range cover, bi-fold  
964383-01 Range covers, Corian, set

### DOMETIC REFRIGERATOR, RM3862R (800-366-3842)

690370-01 Refrigerator, 2-way, RH, RM3862R  
801225-014 Door panel, upper, Oak, 15.5" x 20.38"  
801225-034 Door panel, lower, Oak, 38.38" x 20.38"  
690370-100 Cooling unit, RM3862  
381207-03 Vent, roof, Dometic, polar white

# 2000 LAND YACHT XC 35FT.PUSHER

## ATWOOD WATER HEATER

- 690405 Water heater, Atwood, electronic ignition, 110 volt/gas  
6 gallon, (710688 and prior)
- 690417-01 Water heater, 10 gallon, electronic ignition, 110 volt/gas  
(710689 and later)
- 690209 Access cover, brushed aluminum
- 690417-02 Access cover, white
- 690417-03 Mounting flange, white, 10gal.
- 500933 Switch, water heater, electronic

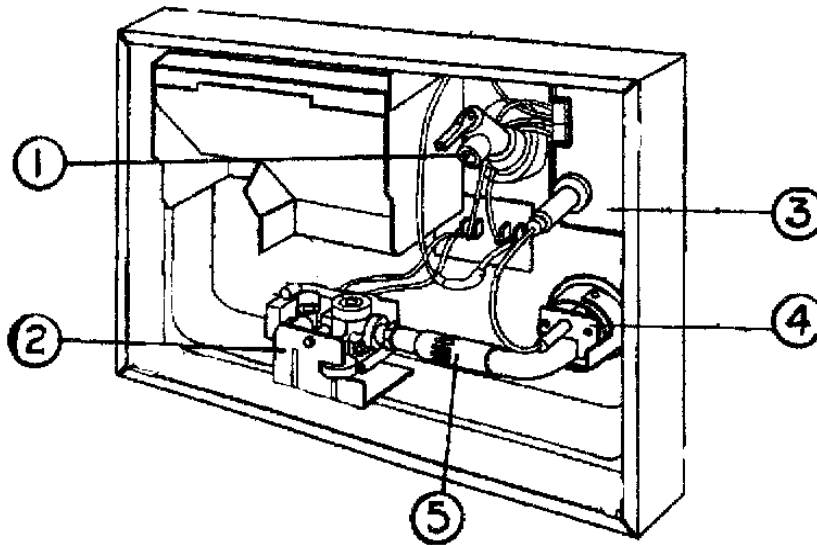

### Front of water heater

- 1) 091604 Relief valve, pressure/temperature
- 2) 093870 Solenoid valve
- 3) 093865 Circuit board
- 4) 093868 Spark probe
- 5) 092615 Main burner

### Back of water heater

- 091160 Heating element, 110volt
- 091873 ECO thermostat
- 091092 On/off switch, 110Volt

# 2000 LAND YACHT XC 35FT.PUSHER

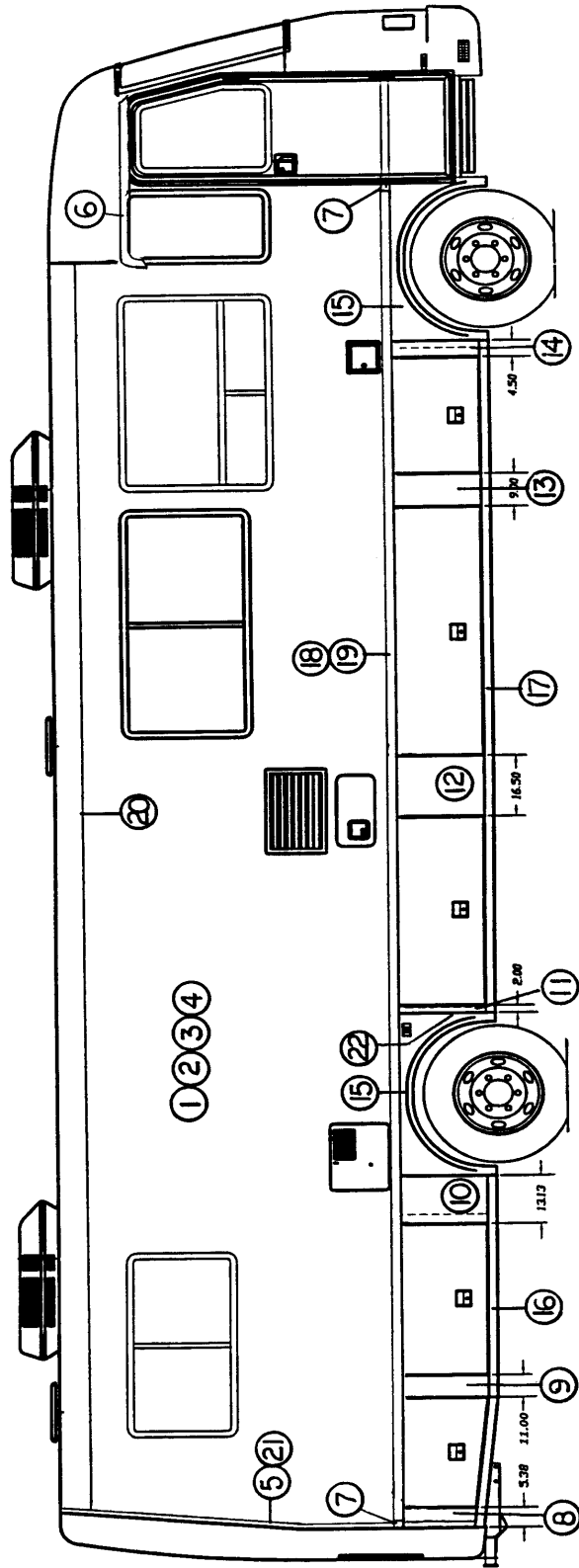

2000 LAND YACHT XC 35FT.PUSHER  
CURBSIDE WALL, **PUSHER W/SLIDE-OUT**

- |               |   |
|---------------|---|
| 1) 801002-13  | Fiberglass sheet, white 77.5" x 400"              |
| 2) 915539     | Weldment, CS wall                                 |
| 3) 203075     | Styrofoam sheet, 1½" thick                        |
| 4) 801261-01  | Paneling, interior, 1/8" x 4' x 7' G1S, Ant. Buff |
| 5) 114005-02  | Extrusion, trim, cap to sidewall, white           |
| 6) 114808-04  | Drip cap, cab window, CS                          |
| 7) 385983-01  | End cap casting, white                            |
| 8) 114835-02  | Filler panel, angled, CS rear, 5.38"              |
| 9) 114778-05  | Filler panel, 11.00"                              |
| 10) 114780-03 | Filler panel, behind rear fender skirt, 13.13"    |
| 11) 114779-01 | Filler panel, fwd. of rear fender skirt, 2.00"    |
| 12) 114778-04 | Filler panel, 16.50"                              |
| 13) 114778-03 | Filler panel, 9.00"                               |
| 14) 114780-04 | Filler panel, behind front fender skirt, 4.50"    |
| 15) 203124-01 | Fender skirt (front and rear are the same)        |
| 16) 114836-02 | Rocker panel, angled, CS rear                     |
| 17) 114708-01 | Rocker panel, straight                            |
| 18) 114831    | Extrusion, rub rail carrier                       |
| 19) 203080-01 | Molding, rub rail, white                          |
| 20) 114570    | Awning rail                                       |
| 21) 320124-06 | Screw #6 x 1.0" C.S., head, stainless, white      |
| 22) 114070-02 | Extrusion, J-trim, gray                           |

# 2000 LAND YACHT XC 35FT.PUSHER

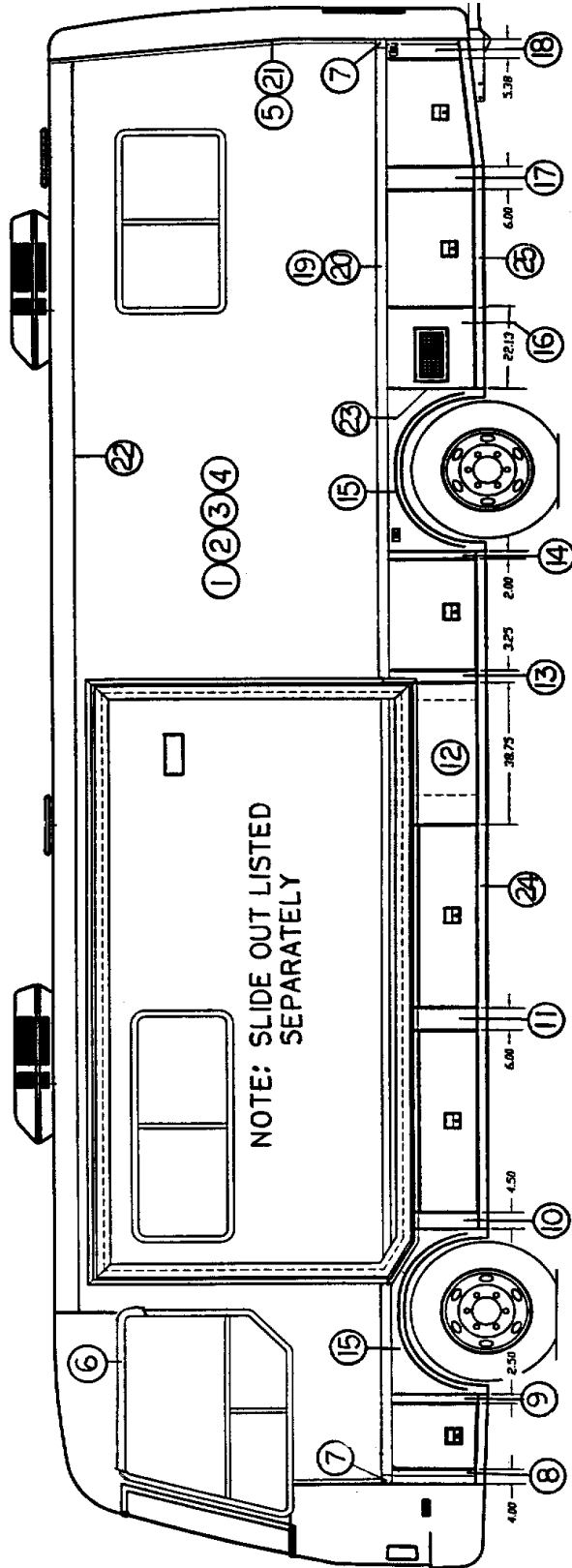

## 2000 LAND YACHT XC 35FT.PUSHER

### ROADSIDE WALL, **PUSHER W/SLIDE-OUT**

**Note: slide-out on separate page**

- |               |   |
|---------------|---|
| 1) 801002-13  | Fiberglass sheet, white, 77.5" x 400"                 |
| 2) 203075     | Styrofoam sheet, 1½" thick                            |
| 3) 915538     | Weldment, RS wall                                     |
| 4) 801261-01  | Paneling, interior 1/8" x 4' x 7' G1S, Antiquity Buff |
| 5) 114005-02  | Extrusion, trim, end cap to sidewall, white           |
| 6) 114808-03  | Drip cap, cab window, RS                              |
| 7) 385983-01  | End cap casting, rub rail, white                      |
| 8) 114788-01  | Filler panel, front RS, angle forward                 |
| 9) 114789-01  | Filler panel, front RS, angle aft                     |
| 10) 114843-01 | Filler panel, under slide, forward                    |
| 11) 114842-01 | Filler panel, under slide, between doors              |
| 12) 114845-01 | Filler panel, under slide, 38.75"                     |
| 13) 114844-01 | Filler panel, aft of slide, 3.25"                     |
| 14) 114780-01 | Filler panel, front of rear fender skirt, 2.00"       |
| 15) 203124-01 | Fender skirt (front and rear are the same)            |
| 16) 114779-04 | Filler panel, behind rear of fender skirt, 22.13"     |
| 17) 114778-02 | Filler panel, 6.00"                                   |
| 18) 114835-01 | Filler panel, RS rear, 5.38"                          |
| 19) 114831    | Extrusion, rub rail carrier                           |
| 20) 203080-01 | Molding, rub rail white                               |
| 21) 320124-06 | Screw #6 x 1.00", c.s. head, stainless, white         |
| 22) 114570    | Awning rail   |
| 23) 114070-02 | Extrusion, J-trim, gray                               |
| 24) 114708-01 | Rocker panel, straight                                |
| 25) 114836-01 | Rocker panel, angled, RS rear                         |

# 2000 LAND YACHT XC 35FT.PUSHER

## SLIDE OUT EXTRUSION

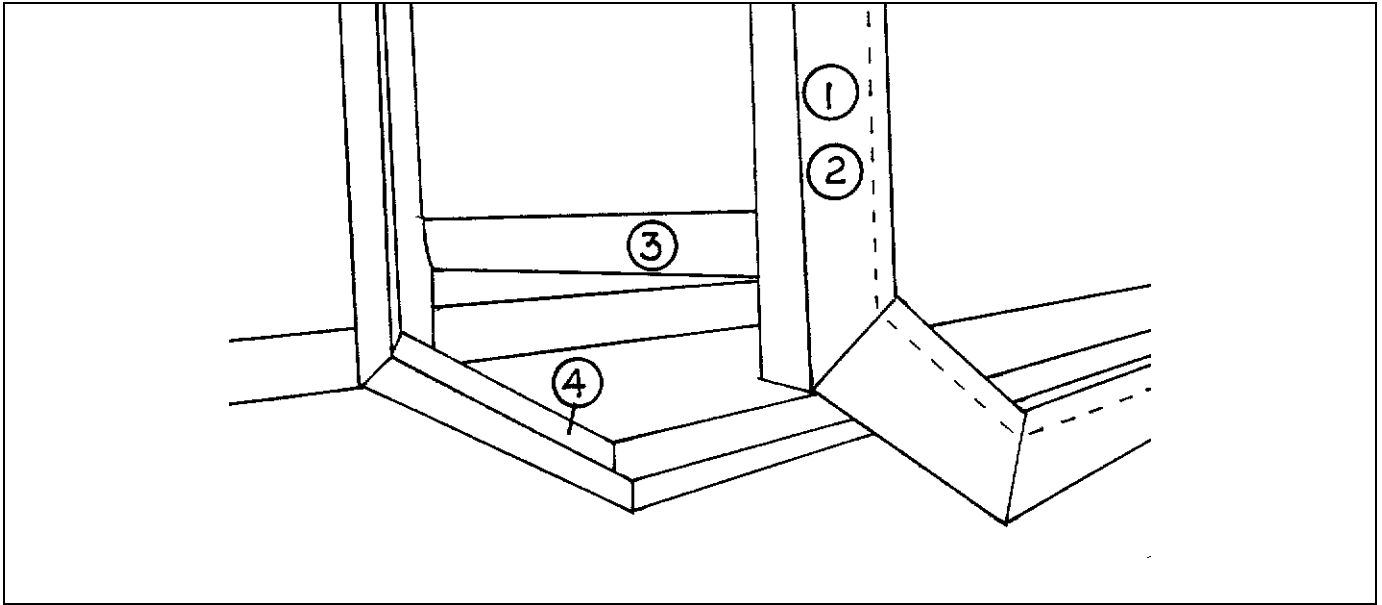

Lower front corner, extended



\*1) 114771 Extrusion, slide out trim

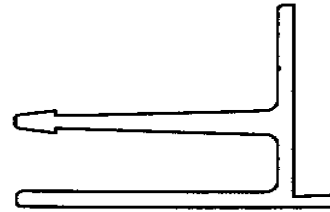

2) 114770 Extrusion, slide out box (fits behind 1)

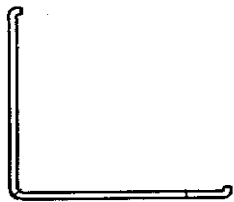

3) 114768 Extrusion, slide out corner trim

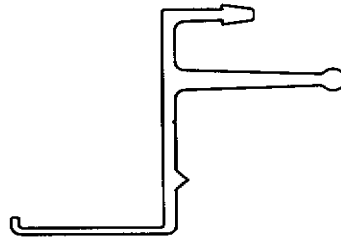

4) 114726 Extrusion, slide out frame

\*This trim is slotted to allow adjustment to the sidewall Cutout. Fitting will be required.



# 2000 LAND YACHT XC 35FT.PUSHER

\* SLIDE OUT GASKETS

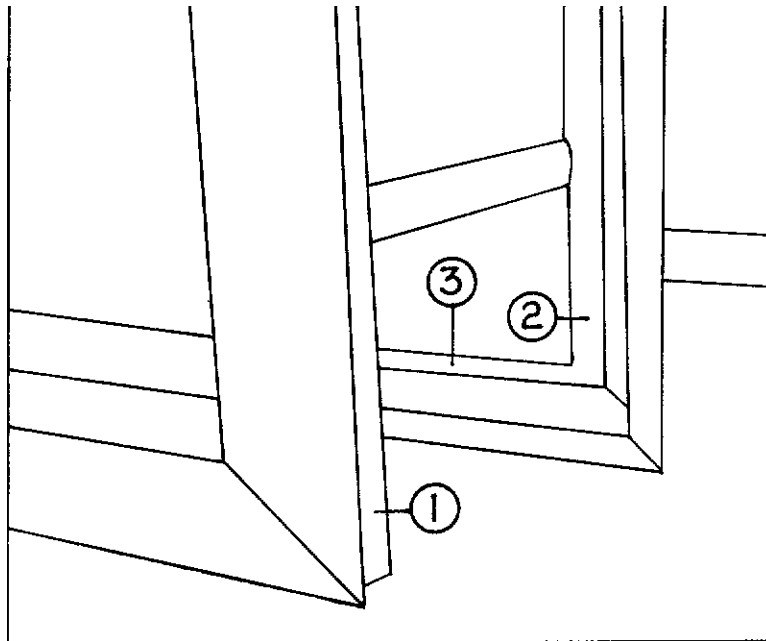

Lower rear corner, extended

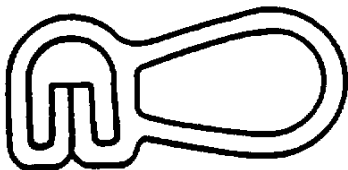

381594 Rubber extrusion  
bulb type, black

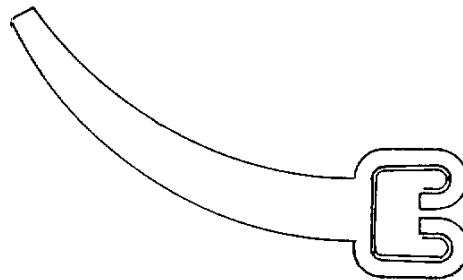

381587 rubber extrusion,  
wiper

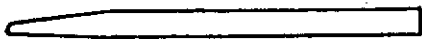

381589 Rubber extrusion  
floor wiper



381588 Rubber extrusion,  
bulb w/tape, used on inside wall

\*Note: Mounting brackets can be found in hardware.

# 2000 LAND YACHT XC 35FT.PUSHER

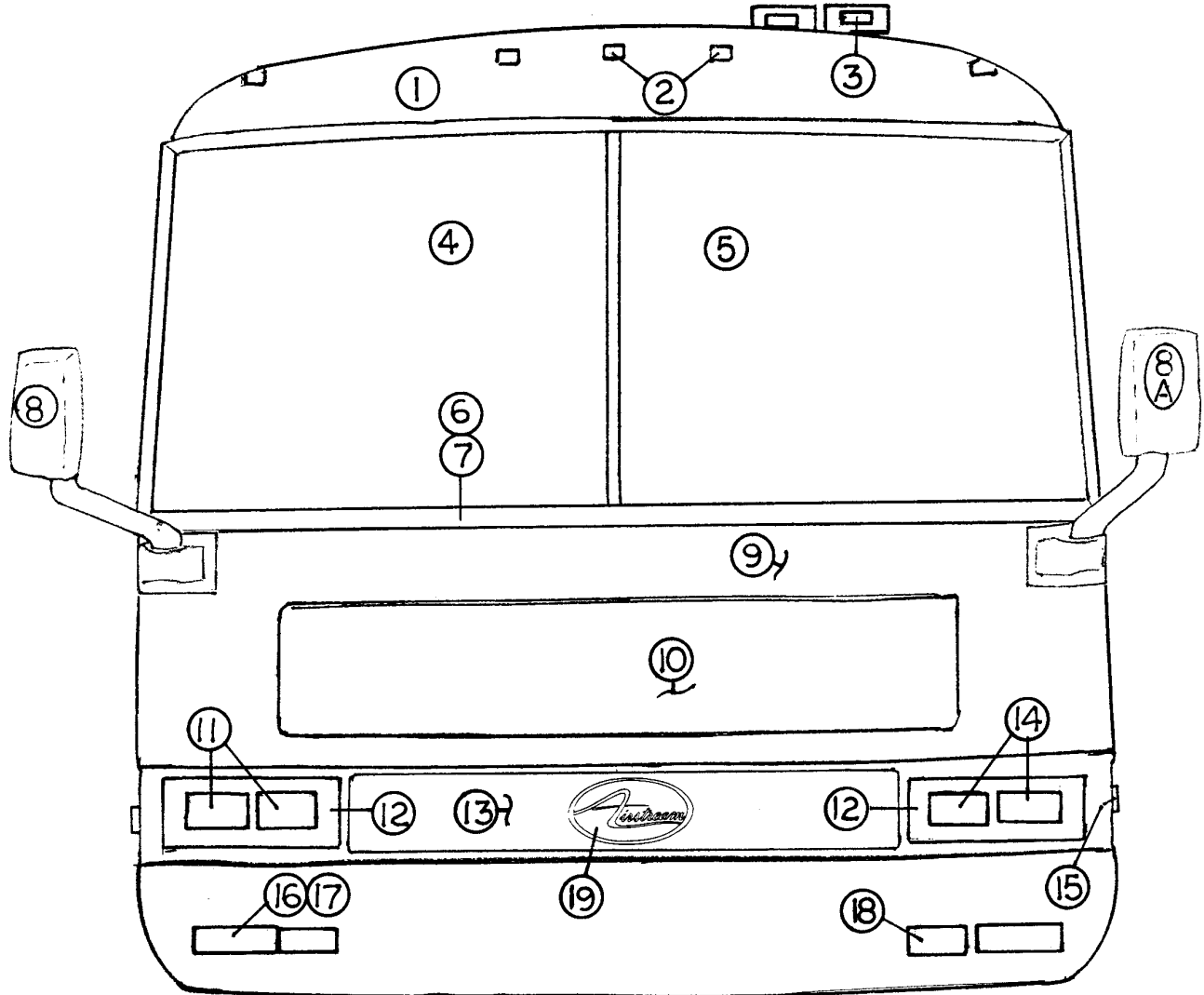

# 2000 LAND YACHT XC 35FT.PUSHER

## FRONT END

- |               |   |
|---------------|---|
| 1) 203013-02  | Front cap, Cutter                           |
| 2) 510984-02  | Light clearance, amber                      |
| 3) 510804     | Horn, air, chrome, #981-D                   |
| 4) 371339     | Windshield, CS                              |
| 5) 371338     | Windshield, RS                              |
| 6) 381524     | Gasket, windshields(surrounds both sides)   |
| 7) 201260     | Insert rubber, windshield gaskets           |
| 8) 511512-02  | Mirror, Velvac, w/remote, heated, CS, black |
| 8a) 511512-01 | Mirror, Velvac, w/remote, heated, RS, black |
| 9) 203102-02  | Nose w/bumper, 2-tone, Cutter Pusher        |
| 10) 203094    | Hood, fiberglass, white                     |
| 11) 511246-02 | Head light, dual, RH                        |
| 12) 386009    | Trim headlight, stainless steel             |
| 13) 386008    | Trim, center nose, stainless steel          |
| 14) 511246-01 | Head light, dual, LH                        |
| 15) 511250-02 | Light, turn & clearance, amber              |
| 16) 511251-01 | Lamp, front turn and parking, w/clear lens  |
| 17) 511251-02 | Socket, front turn and parking light        |
| 18) 511489    | Aux., headlight kit                         |
| 19) 386043-03 | Medallion, Airstream, black                 |

### Not shown:

- |           |                               |
|-----------|-------------------------------|
| 114725-01 | Cover, A pillar, exterior, RS |
| 114830-01 | Cover, A pillar, exterior, CS |

# 2000 LAND YACHT XC 35FT.PUSHER

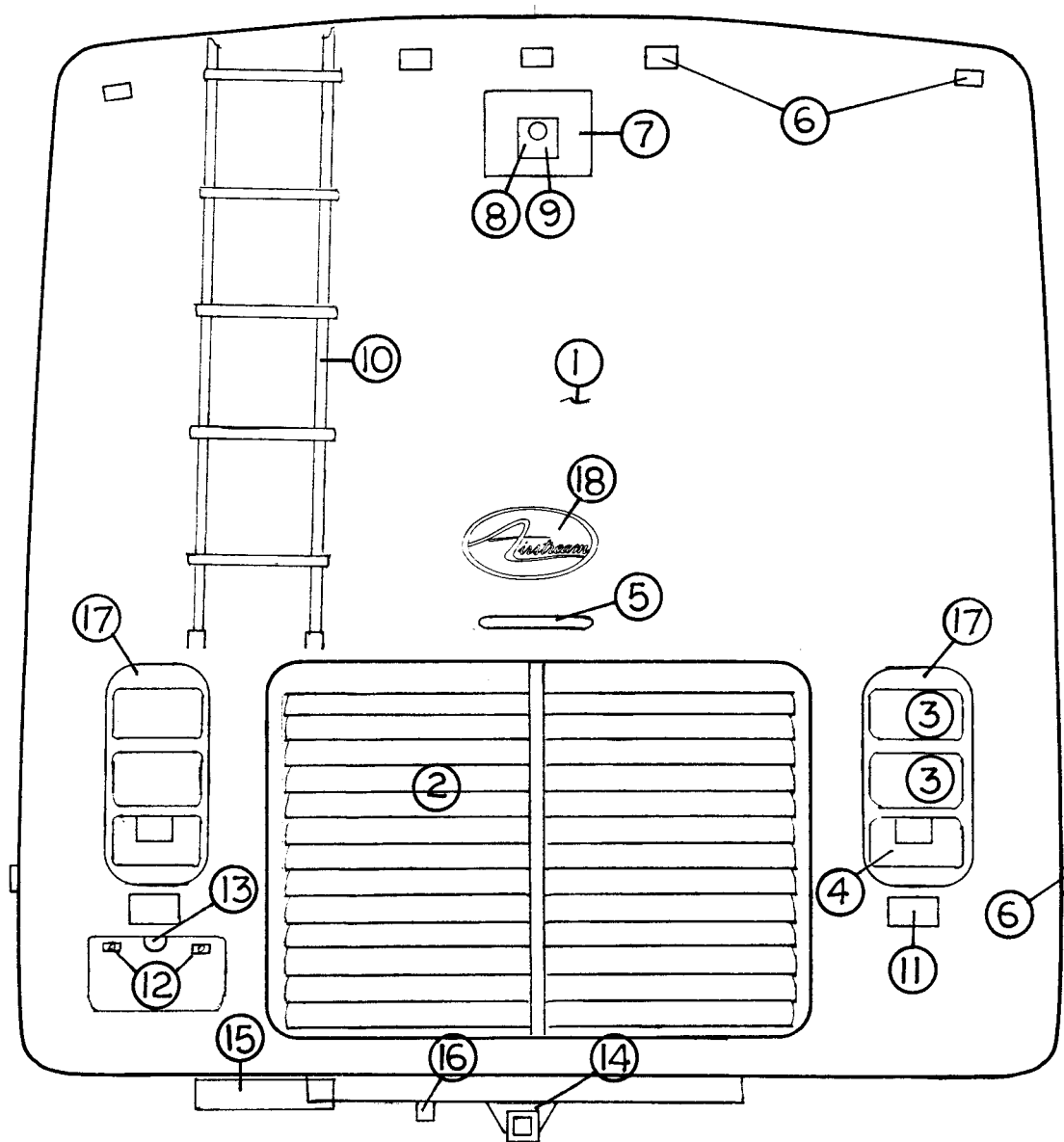

# 2000 LAND YACHT XC 35FT.PUSHER

## AFT END

- 1) 203136-01 Rear cap, two tone, Cutter Pusher
- 2) 922459-01 Door, rear engine access, louvered
- 3) 511239 Light, stop, tail and turn
- 4) 511240 Light, stop, tail, turn and back up
- 5) 511154-02 Light strip, 3rd brake light 1"x10"
- 6) 510984-01 Light, clearance, red
- 7) 203032 Cover, outer, rear monitor
- 8) 510918-01 Monitor, rear, Sony Watchman
- 9) 511044-03 Actuator, two position, rear camera
- 10) 381639-01 Ladder, rear, Cutter Pusher
- 11) 511101-01 Light, docking, halogen, chrome bezel
- 12) 381077 Well nut, license plate attachment
- 13) 511361 Light, license plate, Cutter
- 14) 410800 Reese Hitch, for Cutter Pusher
- 15) 452454 Bracket, angle, rear ladder support
- 16) 510863-01 Plug, trailer
- 17) 386010 Trim, taillight, stainless steel
- 18) 386043-03 Medallion, Airstream, black

# 2000 LAND YACHT XC 35FT.PUSHER

## ROOF

203024	Fiberglass sheet, roof exterior, 106"wide
114568	Extrusion, roof corner cap
114570	Extrusion, awning rail
702482	Ceiling liner, Spectra Opal
800507-01	Paneling, Luan, ceiling liner backing
201728-01	Extrusion, ceiling trim retainer
201728-03	Extrusion, ceiling trim
203609	Registers, ceiling vents

## 2000 LAND YACHT XC 35FT.PUSHER CHASSIS

410830	Reese hitch, Land Yacht XC
410796-08	Jack kit complete, Freightliner
453547	Bracket, L.P. tank
961001	Step assy., roof ladder
511078	Switch, rocker, 4-gang, by door
511484	Step, electric, double, Kwikiee #904006
511486	Switch, magnetic, round, <b>black</b> , in doorjamb
511022-100	Motor, double step
511022-101	Control box, main, <b>black</b> , Kwikiee #909508
511022-100	Motor, double step
203133	Step trim, plastic
451811	Extender, tire valve
400571	Mud flaps, Freightliner
410829	Exhaust extension 5" x 18", chrome
410773	Hose, fuel fill, 2" I.D.

# 2000 LAND YACHT XC 35FT.PUSHER

## CHASSIS

Acme  
(800-552-2263)

690382-01	Heater, air conditioner evaporator
690356	Kit heater/ac accessory, Freightliner
690355	Condenser tri-pack
511112	Pump, vacuum#4570568
600214-03	Heater hose 5/8
601556	Hose AC #65/16
601557	Hose AC #813/32
601558	Hose AC#125/8
690382-07	Plenum kit, short, w/Acme rotary control
452944-01	Bracket condenser mtg. LH
452944-02	Bracket condenser mtg. RH
453515	Angle, condenser mtg.
690356-100	Dryer, Acme air conditioner, Freightliner
690356-101	Resistor, blower speed control
511452	Fuse holder, ATC, weather proof, blower motor



# 2000 LAND YACHT XC 35FT.PUSHER

## SECTION II

### D through E

#### DASH

Dash parts .....	II-2
DECALS (reference).....	II-3

#### DOORS/WINDOWS/AWNINGS

RS, <b>slide out</b> .....	II-6
CS, <b>slide out</b> .....	II-8
Main & Screen door .....	II-10
Awning chart.....	II-11

DRAPES/BLINDS/VALANCES .....	II-12
------------------------------	-------

#### ELECTRICAL

110 volt.....	II-13
12-volt, chassis .....	II-16
Dash switches/lens.....	II-17
12-volt interior switches.....	II-18
12-volt interior lights .....	II-21
12-volt exterior lights .....	II-20
12-volt mics.....	II-26
Windshield wiper assy.....	II-24

#### ENTERTAINMENT

Televisions.....	II-27
Radios.....	II-27
Rear view monitor.....	II-28



# 2000 LAND YACHT XC 35FT.PUSHER

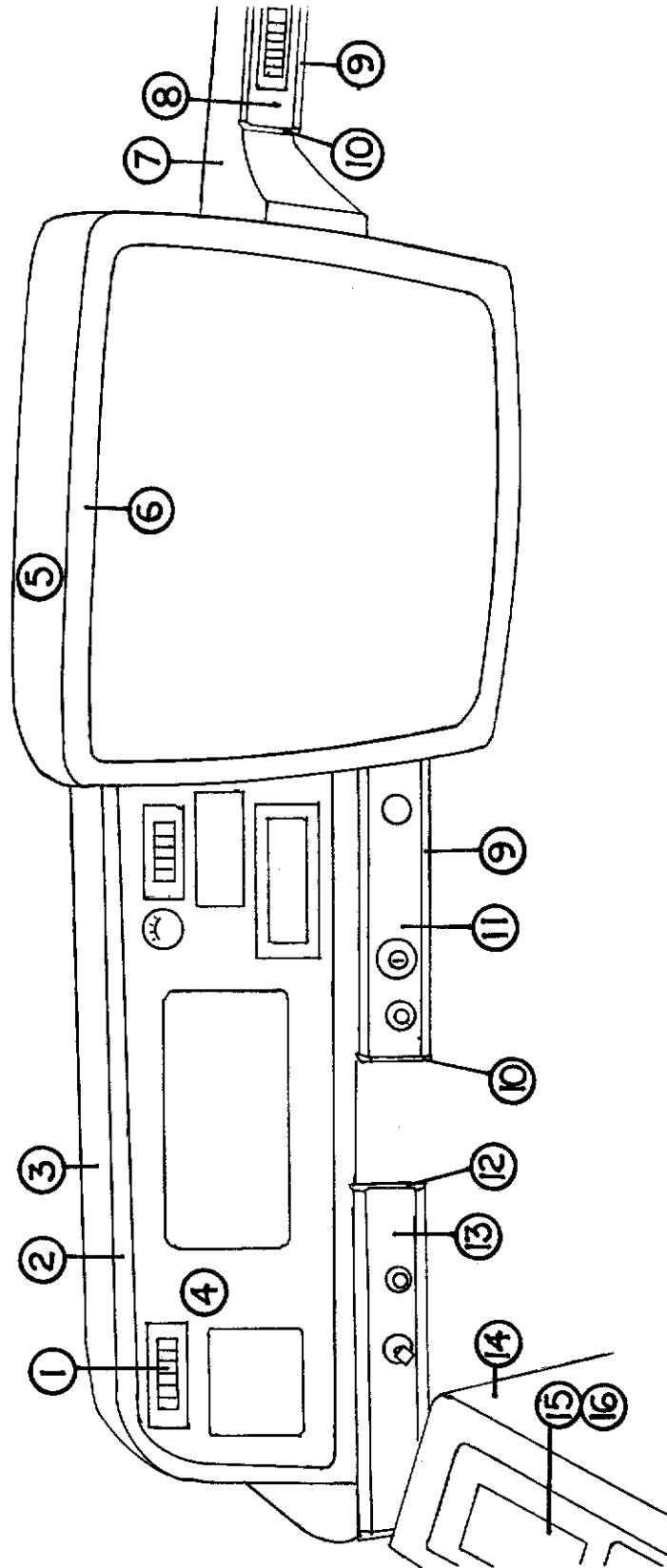

# 2000 LAND YACHT XC 35FT.PUSHER

## DASH

- |               |   |
|---------------|---|
| 1) 690325-03  | Dash louver, A/C-heater, Acme                 |
| 2) 203117     | Trim ring, dash instrument panel              |
| 3) 203092     | Instrument pod                                |
| 3a) 702750    | Vinyl cover, instrument pod                   |
| 4) 203120-01  | Instrument panel, w/trans., temp. cut-out     |
| 4a) 203120-02 | Instrument panel w/cut outs                   |
| 5) 203093     | TV housing                                    |
| 5a) 702751    | Vinyl cover, TV housing                       |
| 6) 203166     | Trim ring, dash TV                            |
| 7) 203126     | Dash panel, main                              |
| 7a) 702811    | Vinyl cover, main dash                        |
| 8) 203137     | Panel, dash insert, CS, wood grain            |
| 9) 114737     | Extrusion, dash face(holds wood grain insert) |
| 10) 114753-01 | Casting, end cap, dash extrusion, LH          |
| 11) 203109-08 | Panel, dash insert, right of steering column  |
| 12) 114753-02 | Casting, end cap, dash extrusion, RH          |
| 13) 203109-07 | Panel, dash insert, left of steering column   |
| 14) 963985-01 | Armrest assy. roadside, Pusher                |
| 15) 203111-06 | Armrest panel, wood grain, w/LP generator     |
| 16) 203111-05 | Armrest panel, wood grain, w/diesel gen.      |

### Not shown:

- |           |  |
|-----------|--|
| 690315-05 | Defroster duct, black, windshield        |
| 500972-03 | Defroster duct, gray, small, side window |
| 386058    | Decal, Land Yacht XC, 7-11/16" x 9/16"   |

# 2000 LAND YACHT XC 35FT.PUSHER

## DECALS

For reference only

There are **no** decals on the exterior of the 2000 Land Yacht 35ft. diesels. Many places, especially the logos, will appear to be decals but are actually painted.

Each vehicle has been provided with a sheet listing the color codes on that particular motorhome. Also, each motorhome is shipped with touch-up paint for each color.

A back-up color chart for each motorhome is kept in Airstream's files. If calling Airstream for this information ask for "Sales" and have the serial number available for them.

# 2000 LAND YACHT XC 35FT.PUSHER

NOTES:

# 2000 LAND YACHT XC 35FT.PUSHER

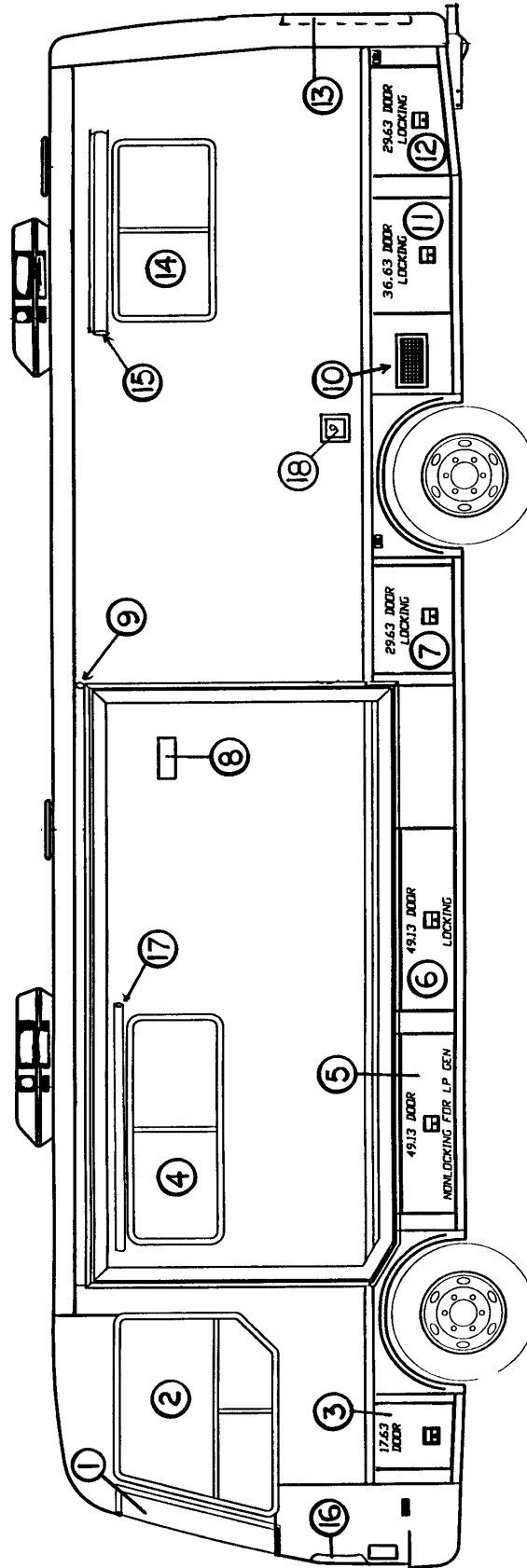

# 2000 LAND YACHT XC 35FT.PUSHER

## DOORS/WINDOWS/AWNINGS, **Slide-out model**

(Hardware such as hinges, locks and latches are located in the **hardware** section of this book)

- 1) 371338 Windshield, RS
- 2) 371365-01 Cab window, RS
- 3) 921174-03 Door, lower compartment, angled, RS front
- 4) 371366-19 Window, RS slider, 22.75x60.25
- 5) 921176-02 Door, lower compartment, 49.13", non-lock
- 6) 921175-02 Door, lower compartment, 49.13"
- 7) 921172-06 Door, lower compartment, 29.63"
- 8) 511152-01 Vent cover, range hood
- 9) 702842-01 Cover, roll-up, slide out
- 10) 921177 Grill, air intake, engine
- 11) 921172-07 Door, lower compartment.36.63"
- 12) 921174-05 Door, lower compartment, angled, RS rear
- 13) 922459-01 Door, rear engine access, louvered
- 14) 371366-22 Window, RS slider, egress, 30.30x48.9"
- \*15) Awning, window, 5'
- 16) 203094 Hood, fiberglass, white
- \*17) Awning, window, 6'
- 18) 201865-02 Fuel fill housing, polar white

\*See awning chart page II-11



# 2000 LAND YACHT XC 35FT.PUSHER

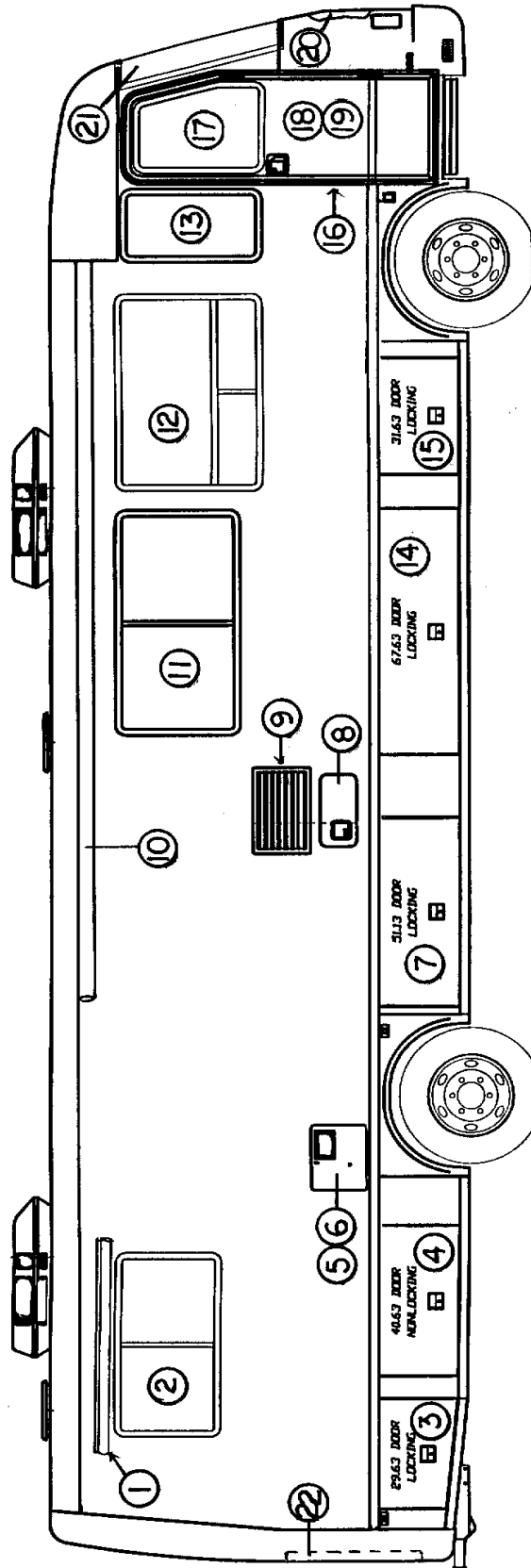

# 2000 LAND YACHT XC 35FT.PUSHER

## DOORS/WINDOWS/AWNINGS **Slide-out model**

(Hardware such as hinges, locks and latches are located  
in the **hardware** section of this book)

- \*1) Awning, window, 5'
- 2) 371366-21 Window, CS slider, 30.30" x 48.88"
- 3) 921174-06 Door, lower compartment, angled, CS rear
- 4) 921173-02 Door, lower compartment, 40.63"
- 5) 690259-05 Access door, water heater
- 6) 690259-06 Mounting flange, water heater
- 7) 921172-03 Door, lower compartment, 51.13"
- 8) 690274-05 Door, Hydroflame, exterior
- 9) 690340-03 Refrigerator door, flush mount
- \*10) Awning, patio, 17'
- 11) 371366-06 Window, CS slider, 29.75" x 60.25"
- 12) 371366-20 Window, CS "T" slider, 37" x 52.75"
- 12a) 371366-27 Window, CS "T" slider, 37.00" x 50.75" (RLC)
- 13) 371366-15 Window, CS, 18.5" x 35.62"
- 14) 921172-05 Door, lower compartment, 67.63"
- 15) 921172-01 Door, lower compartment, 31.63"
- 16) 922449 Doorjamb
- 17) 371366-16 Window, angled, main door
- 18) 922451 Screen door assy.
- 19) 110413 Main door assembly
- 20) 203094 Hood, fiberglass, white
- 21) 371339 Windshield, CS
- 22) 922459-01 Door, rear engine access, louvered

\*See awning chart page II-11

# 2000 LAND YACHT XC 35FT.PUSHER

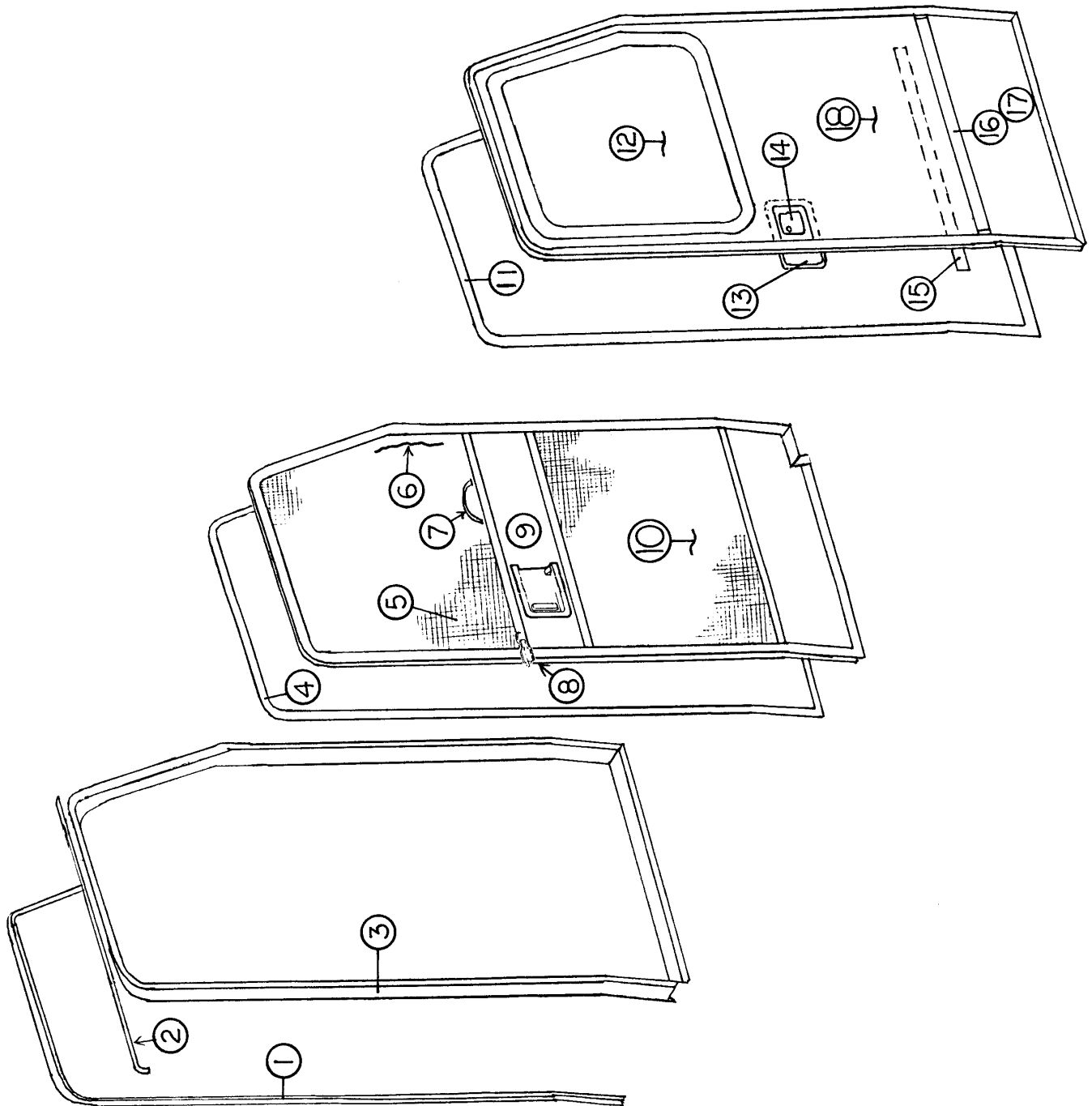

# 2000 LAND YACHT XC 35FT.PUSHER

## MAIN and SCREEN DOOR

- |               |   |
|---------------|---|
| 1) 114829     | Trim, inside doorjamb   |
| 2) 114808-04  | Drip cap, main door/window  |
| 3) 922449     | Jamb, main door   |
| 4) 365013-01  | Gasket, screen door, low-density foam   |
| 5) 380079     | Screen, plastic mesh  |
| 6) 200518     | Spline, gray, round, screen installation  |
| 7) 380004     | Pull handle, screen door w/screws   |
| 8) 381454     | Latch, screen door, double action, Bullet   |
| 9) 203000     | Closeout , plastic, sliding, screen door, (Gizzy)   |
| 10) 922451    | Screen door assembly  |
| 11) 365045    | Seal, main door   |
| 12) 371366-16 | Window, angled, main door   |
| 13) 203002    | Cover, inner door lock pocket, plastic  |
| 14) Door lock | The main door lock is made up of five separate parts. See hardware in Section III for listing |
| 15) 114005    | Trim, inside door face(also used as roof trim)  |
| 16) 114865    | Extrusion, rub rail   |
| 17) 203080-01 | Molding, 2", white vinyl, rub rail  |
| 18) 110413    | Main door assembly  |

### Not shown:

- |           |  |
|-----------|--|
| 381632    | Prop, gas spring, 30#(bottom of main door) |
| 381634    | Bracket, prop, LH curve                    |
| 381633    | Bracket, prop, 2"                          |
| 381632-01 | Safety clip, end fitting                   |
| 203156    | Cover, black, bottom main door prop        |

# 2000 LAND YACHT XC 35FT.PUSHER

## AWNINGS

### DRIFTWOOD

702679-52	Awning, patio, 19'
702679-05	Awning, window, 5'
702679-55	Awning, window, 6'
702679-54	Awning, door, 4'

### BLUE BAYOU

702679-57	Awning, patio, 19'
702679-36	Awning, window, 5'
702679-37	Awning, window, 6'
702679-38	Awning, door, 4'

### AUTUMNWOOD/ROMAN SANDS

702679-58	Awning, patio, 19'
702679-40	Awning, window, 5'
702679-41	Awning, window, 6'
702679-43	Awning, door, 4'

### EMERALD CLAY

702679-56	Awning, patio, 19'
702679-45	Awning, window, 5'
702679-46	Awning, window, 6'
702679-48	Awning, door, 4'

### AWNING MOUNTING HARDWARE

702679-11	Hardware, patio awning, tall
702679-12	Hardware, window awning, 5' & 6'
702679-27	Hardware, door awning

# 2000 LAND YACHT XC 35FT.PUSHER

## DRAPES/SHADES/VALANCES

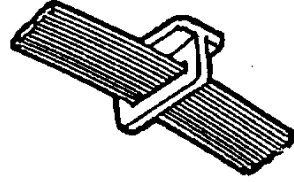

101220  
track, stand off

101217  
track, curtain

700044  
glides, w/elastic "T"

200784	End, curtain track, CS
200785	End, curtain track, RS
703029	Shade, front windshield wrap, set
702818	Shade, Kool Screen, black, cab
702969-34	Shade, pleated, night, 49.5" x 32.5" Ascot
702968-32	Shade, pleated, day/night 51.00" x 40.00" Ascot
702968-33	Shade, pleated, day/night 60.5" x 27.0" Ascot
385963	Bracket, valance mounting, side
964121-01	Valance, lounge/dinette, RS 64.25"
964792-02	Valance, bedroom
964990	Shadow box, bedroom 48.88" x 22.75"
964989	Shadow box, dinette 60.25" x 29.75"
964988	Shadow box, lounge 50.75" x 37.00"
964987	Shadow box, lounge 60.25" x 22.75"

# 2000 LAND YACHT XC 35FT.PUSHER

## \*ELECTRICAL

110 VOLT

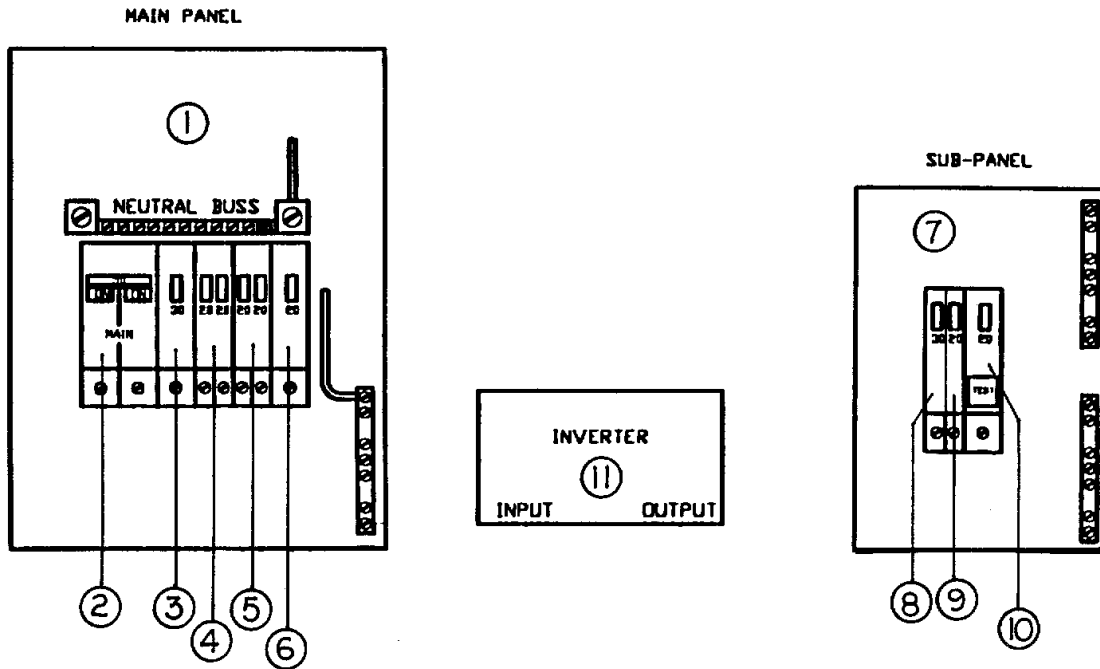

- |               |  |
|---------------|--|
| 1) 511453     | Breaker box, main, Square D            |
| 2) 510724     | Breaker, double pole, 50 amp, Square D |
| 3) 510663     | Breaker, 30 amp, Square D              |
| 4) 510662     | Breaker, double pole, 20/20, Square D  |
| 5) 510662     | Breaker, double pole, 20/20, Square D  |
| 6) 510678     | Breaker, 20 amp, Square D              |
|               |  |
| 7) 511041     | Breaker box, sub-panel, Westinghouse   |
| 8) 510564-02  | Breaker, 30 amp, Bryant                |
| 9) 510564-01  | Breaker, 20 amp, Bryant                |
| 10) 510564-20 | Breaker, 20 amp, GFI, Bryant           |
| 11) 511418-01 | Inverter/charger, 2000watt             |

### Not shown:

- |           |                        |
|-----------|------------------------|
| 511418-02 | Switch, on/off, remote |
| 511418-03 | Fuse holder, 300 amp.  |

\*See ENTERTAINMENT section for radio, VCR, TV, antenna etc

# 2000 LAND YACHT XC 35FT.PUSHER

## ELECTRICAL

### 110 VOLT

511149-04	Power cord, 50-amp w/male end
510562-03	Switch over box, 50 amp, city power to gen.
511020	Generator, Onan Marquis, 6.5 LP
510103	Hour meter, Hobbs
511289	Breaker kit, 30 amp., Onan
511278	Lock out, 110 volt disconnect
510676-01	Outlet, exterior, gray, 110 volt
500785	Outlet, duplex brown
511207	Cover, weatherproof receptacle
511023	Tester, circuit analyzer, 3-wire (provided loose in vehicle)



# 2000 LAND YACHT XC 35FT.PUSHER

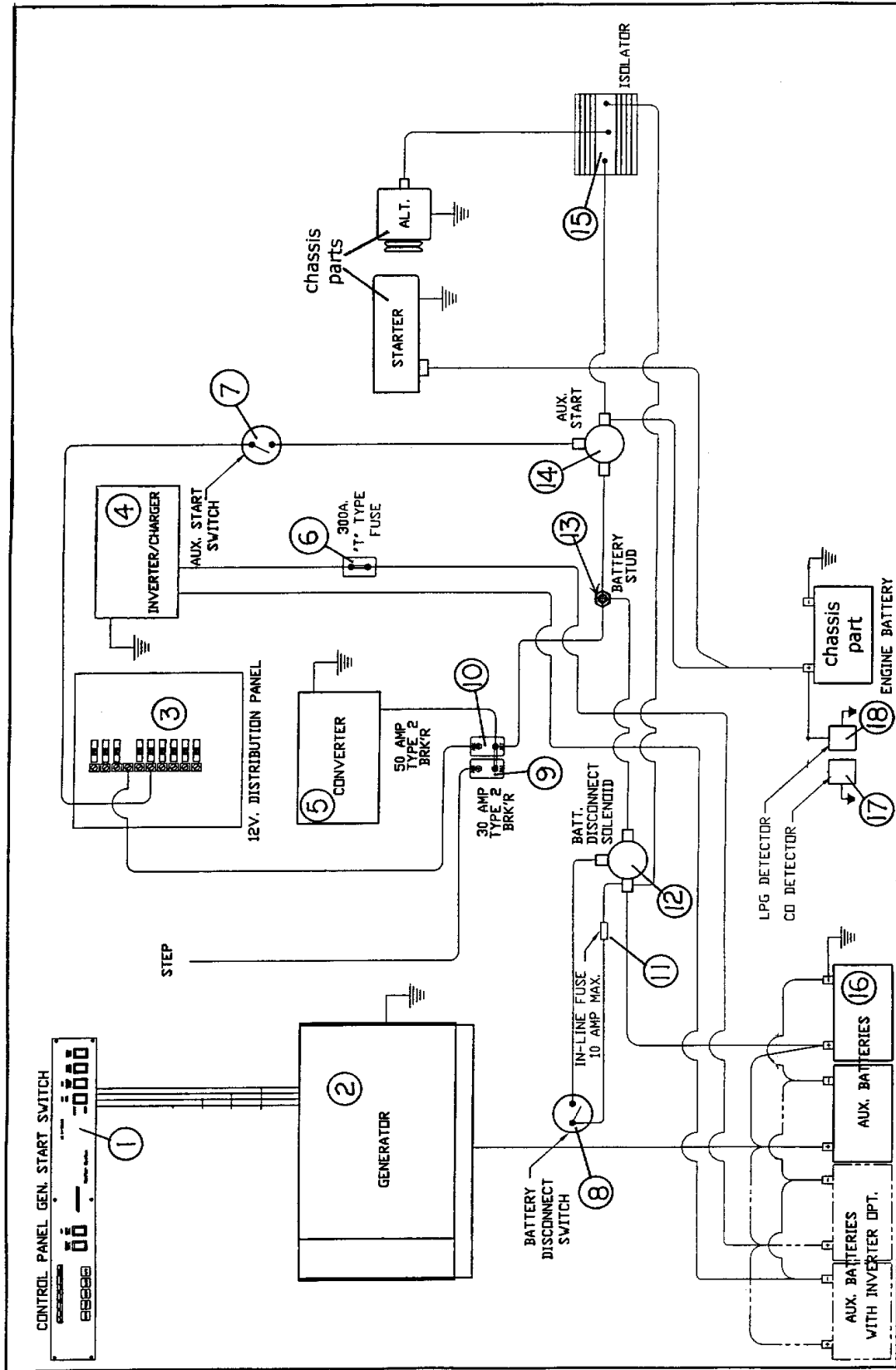

# 2000 LAND YACHT XC 35FT.PUSHER

## \*ELECTRICAL 12-VOLT-CHASSIS

- |               |   |
|---------------|---|
| 1) 511017-16  | Monitor panel   |
| 2) 511020     | Generator, Onan Marquis, 6.5 LP   |
| 3) 511016     | Fuse block, 12-volt, 9 position, ATC type                                 |
| 4) 511418-07  | Inverter/charger, 2000 watt   |
| 5) 500984-04  | Converter, #PC-50(not used with inverter)                                 |
| 6) 511418-03  | Fuse holder, 300 amp  |
| 7) 510929-02  | Switch, auxiliary start, momentary, SPST                                  |
| 8) 962203     | Battery disconnect switch (part of four gang switch cluster at main door) |
| 8a) 511513    | Light, green LED, monitors battery disconnect                             |
| 9) 500475-30  | Breaker, 12-volt DC, 30 amp, w/ears                                       |
| 10) 510947-50 | Breaker, 12-volt, DC, 50 amp  |
| 11) 510696    | Fuse holder, in-line  |
| 12) 511351    | Solenoid, latching, cont. duty, kill switch                               |
| 13) 511090    | Junction block, stud type   |
| 14) 511199    | Solenoid, continuous duty, aux. start                                     |
| 15) 510642-02 | Isolator, 160 amp   |
| 16) 511132    | Battery, deep cycle   |
| 17) 511343    | Detector, carbon monoxide   |
| 18) 511309    | Detector, LPG   |

\*See ENTERTAINMENT section for radio, VCR, TV, antennas etc.

# 2000 LAND YACHT XC 35FT.PUSHER

## ELECTRICAL 12-VOLT-GENERAL

511132	Battery, deep cycle
511418-05	Battery temperature sensor
511016	Fuse block, 12-volt, 9 position, ATC type
511351	Solenoid, latching, cont. duty, kill switch
500475-30	Breaker, 12-volt DC, 30 amp., w/ears
510947-50	Breaker, 12-volt DC, 50amp
511418-07	Inverter/charger, 2000 watt

### 12-volt-\*DASH & ARM REST

510596	Cigarette lighter
510807	Outlet, 12-volt, lighter receptacle
511276	Cover, 12-volt outlet, black

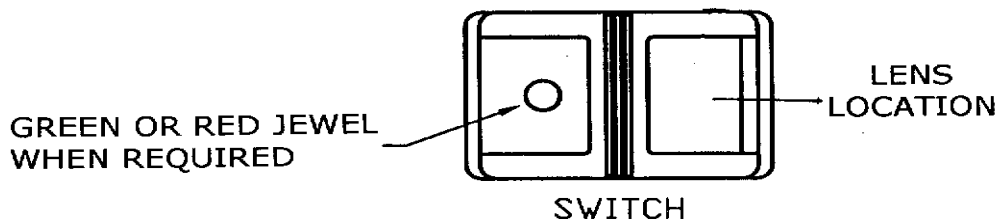

510929-06	Switch, TV speaker, SPST
510929-02	Switch, auxiliary start, ICC blink, momentary, SPST
510929-08	Switch, rear camera, momentary, DPDT
510929-05	Switch, driving light, aisle light, defrost fan, On-Off, SPST
510929-07	Switch, docking light, inverter, On-Off with red indicator light, SPST
511305-10	Switch, remote exterior mirror

\*Note: Engine check, head light switch and air dump valve are provided by the chassis manufacturer.

# 2000 LAND YACHT XC 35FT.PUSHER

## 12-VOLT-DASH SWITCH LENS

510930-01	Lens, ICC blink
510930-02	Lens, door lock
510930-06	Lens, aisle light
510930-33	Lens, auxiliary start
510930-03	Lens, generator
510930-37	Lens, auxiliary headlight
510930-36	Lens, exhaust brake
510930-25	Lens, rear camera
510930-07	Lens, docking light
510930-31	Lens, TV speaker
510930-35	Lens, defrost fan
510930-29	Lens, map light

## 12-volt-INTERIOR SWITCHES

511385-01	Switch, electric source selector, Sony
511325	Switch body with rocker switches, 4-gang by main door
511326	Switch cover, 4 gang printed white, at door
511329	Switch, rocker, SPDT, white, hallway
511327	Switch body w/rocker, single, rear ceiling light
511328	Switch cover, printed white, rear ceiling light
511424	Switch, map light, white
381541-02	Switch, roof vent, bathroom
510868	Switch, 4 gang, bathroom
500933	Switch, water heater
511040	Switch, door, momentary, normally on
962203	Switch cluster, main door
511078	Switch body, illuminated
511083-02	Cover, switch, 3 & 4 gang
511513	Light, green LED, battery switch indicator

# 2000 LAND YACHT XC 35FT.PUSHER

## ELECTRICAL

### 12-volt-INTERIOR LIGHTS

500960-02 680085	Light, fluorescent, recessed, 20.63" Bulb, fluorescent, #F8T5-CW
500960-01 680084	Light, fluorescent, recessed, 14.75" Bulb, fluorescent, #F8T5-CW
51138 50085-02	7Light, decorative, dinette, Acrylic Tiffany Bulb, incandescent, #1141
511298 511298-02 510689	Wall lamp, 12-volt Shade, wall lamp, round Bulb incandescent, #1076
511297 511137-100	Light, halogen w/ switch Bulb, halogen, JC-10, wedge base
500842 680084	Light, fluorescent, 12x5.5x1" Bulb, fluorescent, F8T5-CW
511361	Light, courtesy, flush mount, walkway, black (no separate bulb)
511422 511137-100	Light, map, halogen, white Bulb, halogen, JC-10, wedge base
500956 681924	Light, wardrobe w/switch Bulb, wardrobe light, #581
511417 510689	Wall light, Demi-sconce, slide out Bulb, incandescent, #1076

# 2000 LAND YACHT XC 35FT.PUSHER

## ELECTRICAL

### 12-volt-EXTERIOR LIGHTS

511163	Light, compartment
510672-0	2 Porch light, white(high on side of unit)
510732	Utility light#1327 (by door)
511101-01	Light, docking, halogen, chrome bezel
511239	Light, stop, tail and turn
511240	Light, stop, tail, turn and back up
511154-02	Light strip, 3rd brake light, 1"x10"
510984-01	Light, clearance, red
511361	Light, license plate
511246-02	Head light, dual, RH
511246-01	Head light, dual, LH
500892	Light, turn & clearance, amber
511251-01	Lamp, front turn and parking, w/clear lens
511251-02	Socket, front turn and parking light
510984-02	Light, clearance, amber
511489	Driving light kit
510844-01	Relay, Bosch, driving light

# 2000 LAND YACHT XC 35FT.PUSHER

## ELECTRICAL

### 12-volt-MICS. EQUIPMENT

510804	Air horn, chrome #981-1
510804-01	Elbow kit, air horn
511512-01	Mirror, Velvac, remote, heated, RS, black
511512-02	Mirror, Velvac, remote, heated, CS, black
511305-10	Switch, remote, heated mirrors
511017-06	Monitor panel
511162-01	Keyless entry w/remote
511162-02	Transmitter, 4 channel
510802-01	Actuator, door lock, 5 wire
511412	Solar panel, 10 watt
511413	Light, solar panel
510781	Detector, smoke
511309	Detector, LPG
511343	Detector, carbon monoxide

# 2000 LAND YACHT XC 35FT.PUSHER

NOTES:



# 2000 LAND YACHT XC 35FT.PUSHER

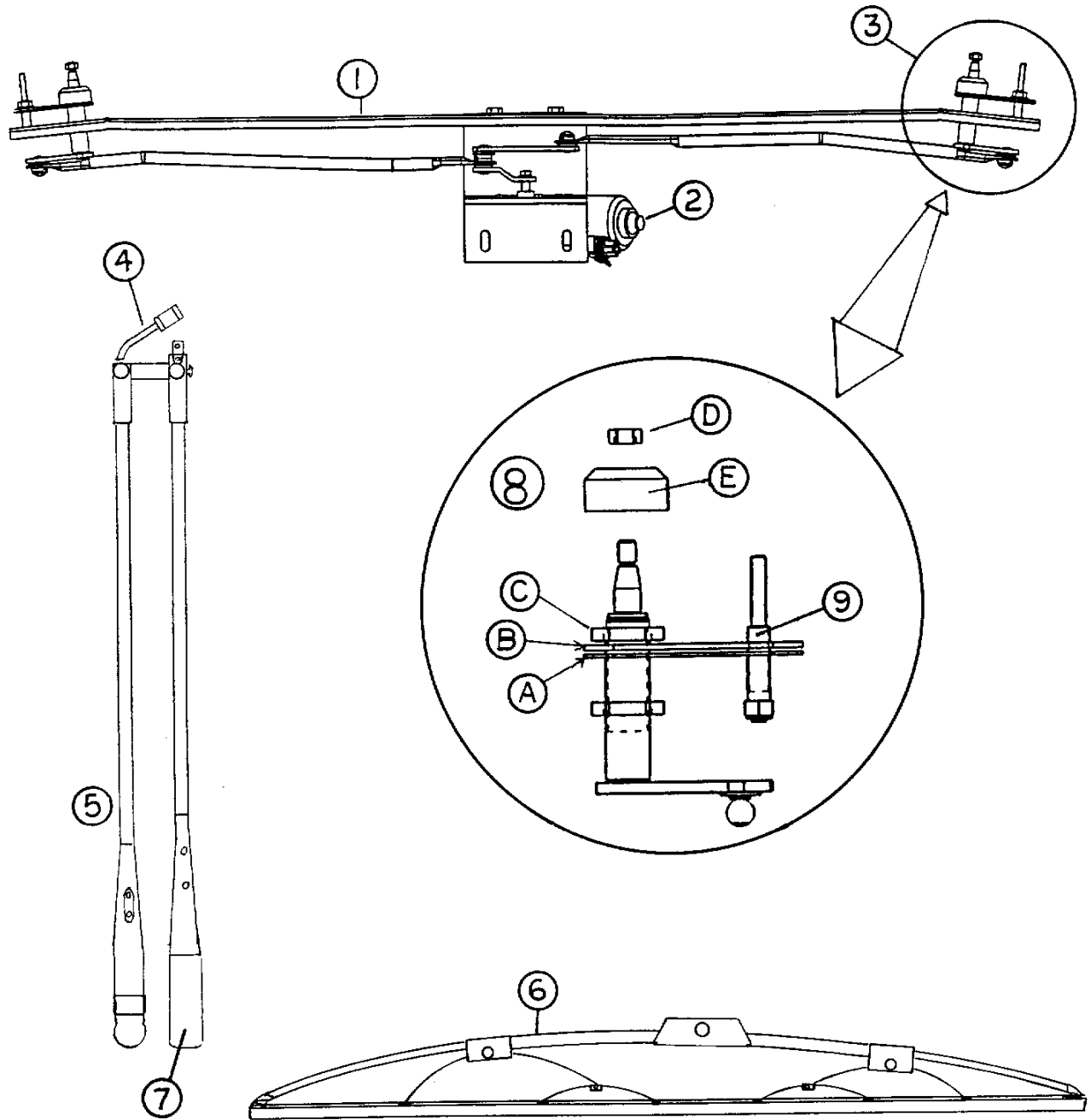

# 2000 LAND YACHT XC 35FT.PUSHER

## DASH-WINDSHIELD WIPER

- 1) 511440 Windshield wiper assy, XL & XC
- 2) 511440-100 Wiper motor, Ford/Freightliner
- 3) 511440-102 Pivot and link assembly, Trico
- 4) 511419-103 Washer jet and tubing, Trico
- 5) 511419-104 Pantograph arm assembly, Trico
- 6) 511419-105 Blade assembly, 28", Trico
- 7) 511419-106 Head cover, main arm, black, Trico
- 8) 511440-107 Hardware kit, includes the following:
  - a) gasket
  - b) face plate
  - c) thin nut
  - d) 8 mm nut
  - e) rain shield
- 9) 511440-108 Swivel assembly, slave arm, Trico

# 2000 LAND YACHT XC 35FT.PUSHER

## ENTERTAINMENT

510788-01	Antenna, TV, Winegard
510788-03	Amplifier, TV antenna
500976	Outlet, TV jack
500996	Jack, TV/phone, gray
500994	Antenna, radio
690427	TV, 19" stereo
203166	Trim ring, TV , front
511373-01	Theatre sound system, 2-18 watt amplifiers (puts TV through front speakers)
690398	TV, RCA, 13"
511464-01	Headphone control
500975	Headphones, lightweight
511464-02	Speaker, 4', 5watt
511464-03	Grill, speaker, black
511423	Plug-earphone
511383-01	Radio w/cassette/changer, XR C6100
511048	Speaker, Coustic, #HS-402
511385	Mobile theater sound system, Sony
511383-02	Remote control, Sony, wireless
511385-02	Amplifier module, Theater sound system
511385-10	Speaker, flush mount, 3"
511385-12	Grill, 3", speaker, white
511385-04	Speaker, 6" x 9", Theater sound
511385-05	Grill, for 6" x 9" speaker
511191	CD changer, 10 disc, Sony CDX-606
690337	Video cassette player, Audiovox
511310	Video control center

## 2000 LAND YACHT XC 35FT.PUSHER

510918-01	Monitor, Sony Watchman
510929-08	Switch, momentary, rear camera
511044-03	Actuator, two position, rear camera
201888	Closeout, monitor camera, interior
203032	Close out monitor camera, exterior

# 2000 LAND YACHT XC 35FT.PUSHER

## SECTION III

### F through H

FASTENERS (common fasteners available locally are not listed)

Rivets .....	III-1
Screws .....	III-3

### FLOOR COVERING

Carpet.....	III-4
Hardwood flooring.....	III-4
Tile .....	III-4
Mats .....	III-4

### FURNITURE

Interior doors .....	III-5
Mirrors .....	III-6
Drawer face .....	III-7
Drawer box .....	III-7
Bedroom furniture.....	III-8
Bath, slide out .....	III-9
Galley, slide out.....	III-10
Lounge, slide out .....	III-12
Cab .....	III-13

### HARDWARE

Exterior locks .....	III-14
Main door/screen door .....	III-15
Exterior access doors.....	III-17
Slide out room.....	III-19
Awning hardware .....	III-21
Interior hardware.....	III-22



# 2000 LAND YACHT XC 35FT.PUSHER

## \*FASTENERS



330126-02  
rivet, pop  
dia. 1/8 "  
grip range .126-.187  
stainless steel body  
stainless steel mandrel

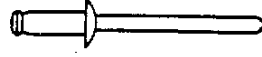

330126-03  
rivet, pop  
dia. 1/8 "  
grip range .126-.250  
stainless steel body  
stainless steel mandrel

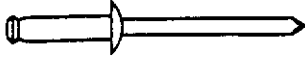

330136-04  
rivet, pop  
dia. 1/8 "  
grip range .313-.375  
stainless steel body  
stainless steel mandrel

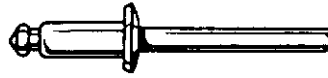

330031-03  
rivet, pop  
dia. 3/16 "  
grip range .125-.250  
stainless steel body  
stainless steel mandrel



330031-03  
rivet, pop  
dia. 3/16 "  
grip range .126-.250  
stainless steel body  
steel mandrel



320108-01  
rivet, bulb tite, w/washer  
dia. 3/16 "  
grip range .050-.187  
aluminum body  
aluminum mandrel

\*Common bolts and screws readily available at local hardware outlets have not been listed.

# 2000 LAND YACHT XC 35FT.PUSHER

## \*FASTENERS

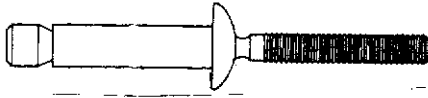

330139-02  
dia. 1/4"  
grip range .350-.625  
stainless steel body  
stainless steel mandrel

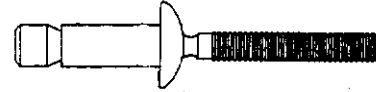

330139-01  
dia.1/4"  
grip range .080-.375  
stainless steel body  
stainless steel mandrel

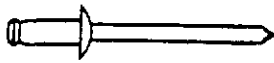

330127-03  
dia. 1/8"  
grip range .063-.125  
aluminum body  
aluminum mandrel



300101  
1/8" I.D.  
washer, aluminum

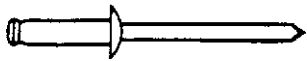

330127-05  
dia. 1/8"  
grip range .251-.312  
aluminum body  
aluminum mandrel

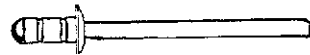

330137  
dia. 1/8"  
grip range .039-.189  
aluminum body  
steel mandrel

\*Common bolts and screws available at local hardware outlets have not been listed.



# 2000 LAND YACHT XC 35FT.PUSHER

## \*FASTENERS



3201223

screw, pan head, Phillipsscrew wood oval head, Phillips  
black  
#4 x 1/8" (glove box tray)



20114-04

screw wood oval head, Phillips  
antique brass  
#5 x 1/2'



320114-05

screw wood, oval head, Phillips  
antique brass  
#5 x 5/8"



320115-06

screw wood, flathead, Phillips  
stainless steel  
#6x1.00"

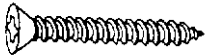

320124-06

screw, flathead, Phillips  
stainless w/white head

\*Common bolts and screws readily available at local hardware outlets have not been listed.

# 2000 LAND YACHT XC 35FT.PUSHER

## FLOOR COVERING

702793-07	*Carpet, Regal/Shadow, Roman Sands
700173	Carpet padding
701538	Carpet, Velour gray, storage compartments
201709-02	Extrusion, trim molding, black, baggage com.
702903-01	Tile, Idaho Beige-13x13
702903-02	Thin set, glue, powder form
702903-03	Matt, tile support
702903-04	Epoxy grout
702903-05	Schluter strip
702550-01	Mat, entrance
702549	Matt, entrance, w/Airstream logo
702812-02	Step, tread, round, black
702893	Step tread, smooth rubber
381346	Floor mats

\*See sample chart provided to your sales department for more carpet and upholstery part numbers.

# 2000 LAND YACHT XC 35FT.PUSHER

## FURNITURE DOORS-INTERIOR

		Inches
800557-394	Door frame	9.75 x 33.00
800557-334	Door frame	11.50 x 19.00
800557-304	Door frame	11.75 x 42.00
800557-094	Door frame	12.75 x 60.00
800557-104	Door frame	22.00 x 60.00
800597-744	Door, raised panel	10.25 x 29.50
800597-174	Door, raised panel	11.50 x 15.75
800597-774	Door, raised panel	11.50 x 18.00
800597-594	Door, raised panel	11.50 x 18.50
800597-764	Door, raised panel	11.50 x 19.00
800597-504	Door, raised panel	12.00 x 29.50
800597-034	Door, raised panel	16.50 x 20.00

## MISCELLANEOUS DOORS

801225-014	Door panel, refrigerator, upper, Oak
801225-034	Door panel, refrigerator, lower, Oak
964413-03	Door, slider, bath, 35' w/slide-out
703034-01	Shower door
702681	Foldette door, Irvine
381563-01	Track, formed, foldette door
381563-02	Track curved, foldette door
800881-144	Door louvered, Oak, 33.25 x 12.00

# 2000 LAND YACHT XC 35FT.PUSHER

## FURNITURE

### MIRRORS

		Inches
372210-04	Mirror, beveled 4 sides	5.50 x 71.75
372210-01	Mirror, beveled 4 sides	6.88 x 30.13
372210-11	Mirror, beveled 4 sides	7.75 x 19.59
372210-02	Mirror, beveled 4 sides	8.62 x 16.62
372210-03	Mirror, beveled 4 sides	8.88 x 39.13
372211-02	Mirror, beveled 3 sides	14.00 x 16.75
372211-01	Mirror, beveled 3 sides	15.25 x 16.75
372212-01	Mirror, beveled 2 sides	12.25 x 25.0
371262-15	Mirror, safety glass	10.56 x 17.12
372203-13	Mirror, safety glass	16.25 x 29.00
371262-04	Mirror, safety glass	22.00 x 60.00

# 2000 LAND YACHT XC 35FT.PUSHER

## FURNITURE

### DRAWER FACES

		Inches
800599-584	Drawer face	4.75 x 21.5
800599-404	Drawer face	7.00 x 10.25
800599-024	Drawer face	7.00 x 11.75
800599-384	Drawer face	7.00 x 21.5
800599-634	Drawer face	7.75 x 60.75
800599-684	Drawer face	10.5 x 24.75
800597-594	Drawer face	11.50 x 18.50
800597-504	Drawer face	11.75 x 29.5
800599-704	Drawer face	12.50 x 21.50
800599-034	Drawer face	16.50 x 20.00

### DRAWER BOXES

964906-05	Drawer box	2.75 x 14.00 x 13.25
964906-02	Drawer box	2.75 x 18.00 x 19.50
964910-05	Drawer box	5.00 x 8.50 x 18.00
964910-02	Drawer box	5.00 x 10.00 x 18.00
964910-08	Drawer box	5.00 x 14.00 x 13.25
964910-03	Drawer box	5.00 x 19.50 x 18.0
964908-03	Drawer box	8.00 x 13.00 x 20.00
964908-04	Drawer box	8.00 x 19.50 x 14.00

964008 Lounge drawer box

# 2000 LAND YACHT XC 35FT.PUSHER

## FURNITURE

### BEDROOM

963959-02	Wardrobe, CS rear
964429	Face frame, CS rear wardrobe
962818-01	Frame, wardrobe shelf
381527	Speedy shelf strip
963959-01	Wardrobe, RS rear
964428	Face frame, RS rear wardrobe
962818-01	Frame, wardrobe shelf
381527	Speedy shelf strip
963861-02	Roof locker, rear
964430-01	Face frame, rear roof locker
381449-04	Rail, decorative, brass
381449-05	Post, decorative rail, brass
964979-02	Bed assembly
964974	Engine box assembly
964977	Top, engine box
964976-01	Side, RH engine box
964976-02	Side, LH engine
963975	Forward wall, engine box
801232	Close out. TV, Oak, 16.25 x 15.25
964556	Shelf, TV support, RCA

# 2000 LAND YACHT XC 35FT.PUSHER

## FURNITURE

\*BATH, 35;' PUSHER

201999	Shower stall, almond
201902	Ceiling liner, shower
381631-01	Sky light, plastic, neo angle, 22x22
203154-01	Inner dome, sky light, neo angle
964178	Laundry/TV cabinet
964437	Face frame, TV/laundry cabinet
964195-02	Lavy assembly
964422	Face frame, lavy
964366-01	Lavy top, Corian
964180	Wardrobe assembly, CS
964420	Face frame, CS wardrobe assembly
964193	Medicine cabinet, forward assembly
962674-01	Face frame, forward medicine cabinet
964194	Medicine cabinet, aft assembly
962728-01	Face frame, aft medicine, cabinet assembly

\*Bath fixtures may be found in the hardware section. If part is connected to or drains water look in plumbing

# 2000 LAND YACHT XC 35FT.PUSHER

## FURNITURE GALLEY AREA

964494	Dinette seat base, RH
964496	Dinette back, RH
964498	Dinette cushion support, RH, 37.63
964334-02	Flex spring seat, 21.63 x 38.0
964493	Dinette seat base, LH
964497	Dinette back, LH
964499	Dinette cushion support, LH 37.63
964334-02	Flex spring seat, 21.63 x 38.0
962720-01	Dinette table, fixed
801054-004	Table top, No-mar finish, 24"
922177-03	Leg, hardwood, 30.50
963654-02	Backsplash, dinette table
964549-01	Roof locker, dinette aft
962709-01	Face frame, dinette roof locker, aft
964549-02	Roof locker, dinette, forward
962708-01	Face frame, dinette roof locker, forward
964548-01	Roof locker, dinette, center
963872-01	Face frame, dinette roof locker, center
964216	Microwave cabinet
964417	Face frame, microwave cabinet
964074-01	Refrigerator cabinet w/pantry
964421	Face frame, refrigerator cabinet w/pantry
381551-01	Pantry rack
381551-02	Wire basket

(continued)



# 2000 LAND YACHT XC 35FT.PUSHER

## FURNITURE

### GALLEY AREA-35'W/SLIDE OUT

964213-02	Galley assembly , forward
964424	Face frame, forward galley assembly
964570	Galley assembly, aft
964569	Face frame, aft galley assembly
964967-01	Galley top, Corian
601633-01	Sink, porcelain, almond
964411-01	Sink cover, RH
964410-01	Sink cover, LH
964215	Roof locker, galley
964418	Face frame, galley roof locker
963990	Magazine rack

# 2000 LAND YACHT XC 35FT.PUSHER

## FURNITURE LOUNGE AREA-35' W/SLIDE OUT

964191	Roof locker, lounge, 59"
964425	Face frame , lounge roof locker
964196	Roof locker, lounge, 68.5"
964423	Face frame, lounge roof locker, 68.5"
702901-01	Swivel chair, Villa
*702899-399	Sofa, jackknife, 68", Roman Sands
964210	End table
964416-004	Face frame, end table
964260-004	Top, end table
964227	Letter rack

\*Changing the-(dash) number to:

318 = Blue Bayou  
258 = South Beach  
248 = Vintage Leaf  
379 = Mosaic Blue  
389 = Tropical Isle

# 2000 LAND YACHT XC 35FT.PUSHER

## FURNITURE/TRIM

### CAB AREA

964135	Arm rest, CS
200892	Cupholder, chrome plastic
963985-01	Arm rest, RS
203111-06	Top, RS armrest w/LP generator
964109	Roof locker, front(above windshield)
964444-01	Face frame, front roof locker
964111	Bottom, front roof locker
964986	Cabinet assembly, below TV
964985-004	Face frame, cab cabinet
801193	Beverage holder, Oak
203011-01	Beverage tray cup holder, LH
203011-02	Beverage tray cup holder, RH
203234	Cup holder, pop-out, black
702897-05	Driver seat, power
702898-02	Passenger seat, non-power
511503	Kit, vibrasonic seat
964136	Step cover assembly
800631	Handrail, Oak
964984	Close out, upper cab, RS
964983	Close out, upper cab, CS
381515-04	Visor, front windshield
203158-61	Cover, A-post, RS
203139-01	Cover, A-post, CS
203040	Cover, center windshield post

# 2000 LAND YACHT XC 35FT.PUSHER

## HARDWARE EXTERIOR-MAIN/SCREEN DOOR

### TRIMARK main door lock

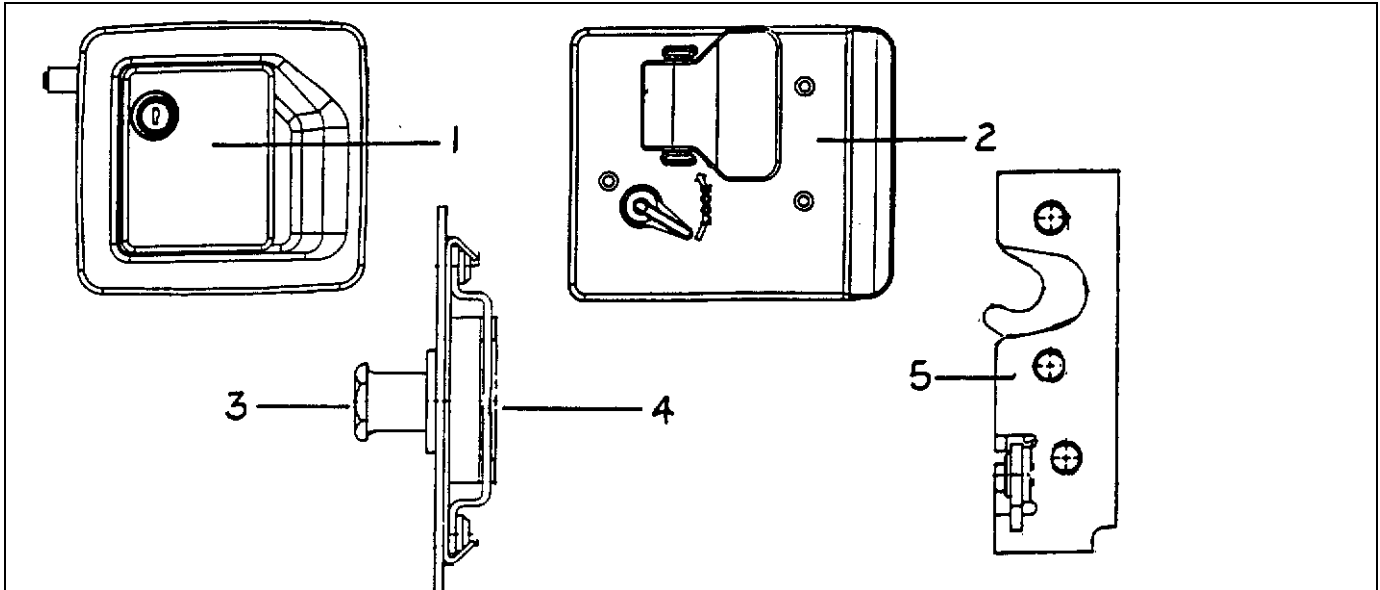

- |              |                                 |
|--------------|---------------------------------|
| 1) 381521-01 | Outside lock housing            |
| 2) 381521-02 | Inside lock plate               |
| 3) 381284    | Striker bolt                    |
| 4) 381521-04 | Caged nut                       |
| 5) 381521-03 | Rotary latch                    |
| 381521-05    | Screws, inside lock plate       |
| 203127       | Cover, inner door lock, plastic |

### Dead bolt-Trimark

- |           |                                    |
|-----------|------------------------------------|
| 510802-01 | Actuator, door lock, 5-wire        |
| 381323-01 | Dead bolt assembly                 |
| 452030    | Bolt, Trimark dead bolt            |
| 381326    | Striker, 10007-w/Trimark dead bolt |
| 345321-12 | Screw, #8-32, flat head, black     |
| 200772    | Pan, plastic, dead bolt, interior  |

# 2000 LAND YACHT XC 35FT.PUSHER

## HARDWARE EXTERIOR-MAIN/SCREEN DOOR

- 381334 Hinge leaf, jamb, main door
- 381336 Hinge leaf, door, main
- 381377 Hinge leaf, screen door
- 385599-075 Bearing, sleeve, main door hinge
- 300118-01 Washer, nylon, main door hinge
- 310024 Hinge pin, .250 x 6.0"

- 381632 Prop, gas spring, 30#(bottom of main door)
- 381634 Bracket, prop, LH curve
- 381633 Bracket, prop, 2"
- 381632-01 Safety clip, end fitting
- 203156 Cover, black, bottom main door prop

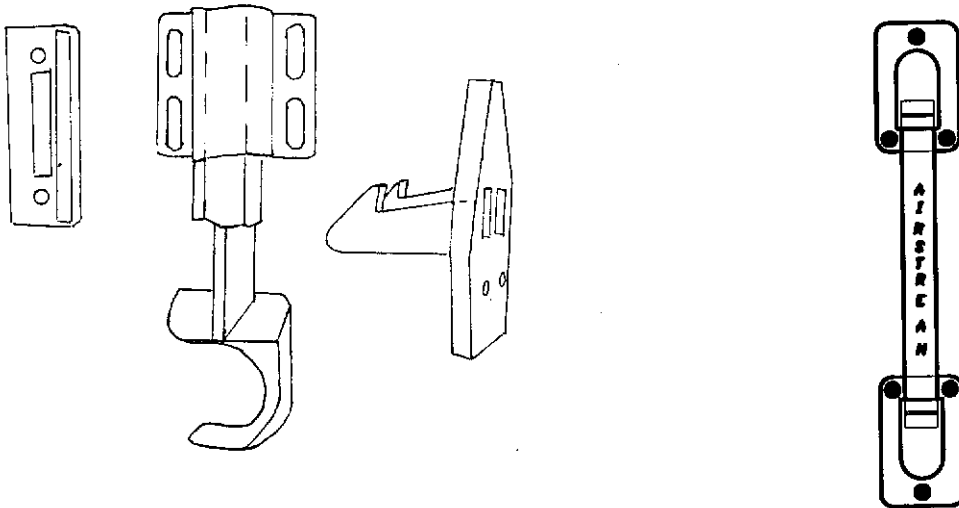

- 381454 Latch, screen door,  
Bullet

- 381696 Grab handle  
embossed "AIRSTREAM"

# 2000 LAND YACHT XC 35FT.PUSHER



380004 Handle, screen door

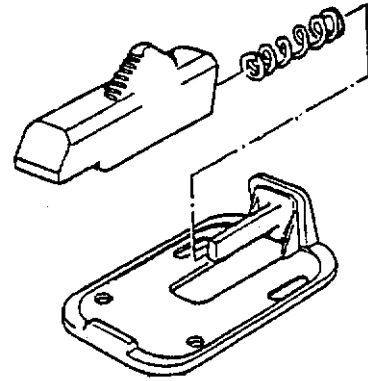

380291 Main door hold back  
Used w/housing #380290

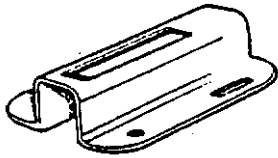

380290 Latch housing,  
main door hold back

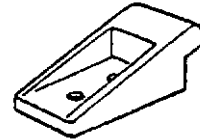

201056 Catch, main door  
hold back

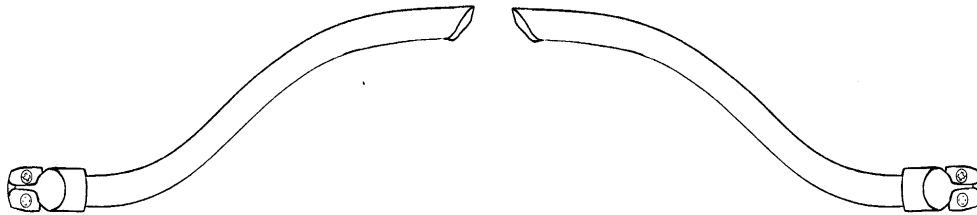

381699 Handle, exit, interior, doorjamb mount

# 2000 LAND YACHT XC 35FT.PUSHER

## HARDWARE

### EXTERIOR-BAGGAGE COMPARTMENT

381569-01	Prop, spring, gas.50#
381569-02	Prop, spring, gas, 60#
381569-03	Prop, spring, gas, 40#
381262	Bracket, prop w/ball, mounts on jamb
914163	Bracket, door prop, mounts on door
381565-01	Handle assembly, locking w/collar
381565-02	Handle assembly, non locking
381565-04	Plunger bolt assembly
381484	Strike, compartment door
381456	Cable, coated
381455	Loop sleeve, crimp on cable clamp
381523-01	Hinge, baggage door
365232	Seal, baggage door
203122	Cover, compartment latch, inside

### EXTERIOR-REAR LOUVERED DOORS

381434	Hinge, stainless, 3" x 3"
381227-01	Latch, vise action, curved pawl
114827	Plate, rear door latch

# 2000 LAND YACHT XC 35FT.PUSHER

## HARDWARE EXTERIOR-FRONT HOOD

400890	Hinge arm, hood
400895	Brace, hinge arm
453377	Hood hinge stop
400889	Bracket, hood latch
381580	Compression spring
385587	Cap, hood bumper
453374	Clip, alignment, hood
381579-02	Paddle latch
385945	Grommet, hood stop
453405	Extension, hood release
203108	Cap, vinyl, hood release, white



# 2000 LAND YACHT XC 35FT.PUSHER

## HARDWARE EXTERIOR-SLIDE OUT ROOM

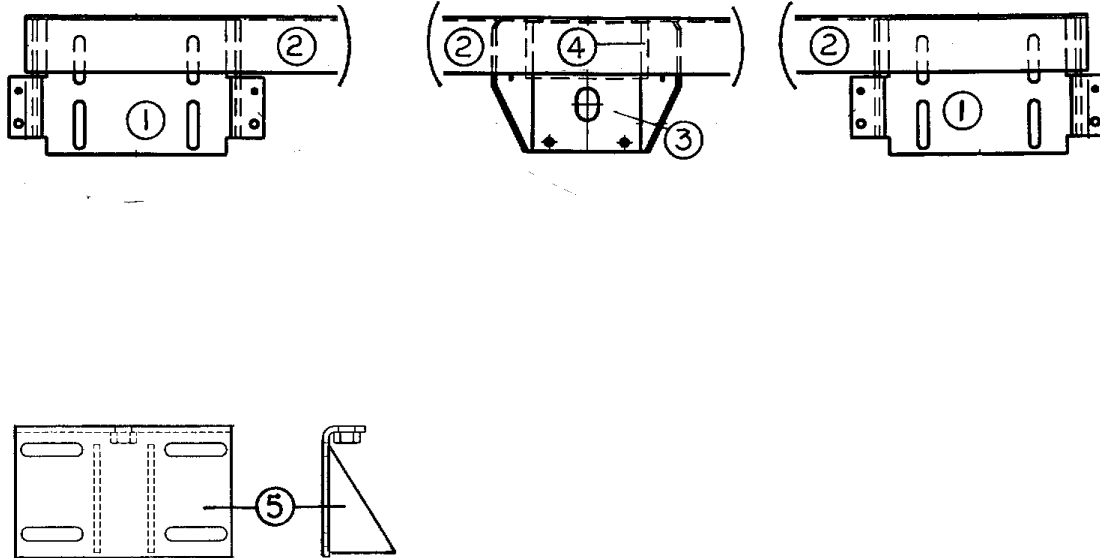

- 1) 915470 Mounting bracket, slide out room
- 2) 915390 Mounting angle
- 3) 915334 Mounting bracket, rod/room
- 4) 915391 Mounting angle, 6.50 x 3.25 x 6.50
- \*5) 915471 Bracket, slide out arm

\*Note: Item 5 acts as the connector between the slide-out arms and the angle, item 2, that runs across the bottom of the room.

## INTERIOR-SLIDE OUT ROOM

- 381592-01 Bar, travel lock, 10.25", adjustable
- 381623 Roller, floor slide out

# 2000 LAND YACHT XC 35FT.PUSHER

## HARDWARE EXTERIOR-SLIDE OUT ROOM

FOR REFERENCE ONLY - Airstream does not stock  
DeWald parts.



### DEWALD MANUFACTURING INCORPORATED

1823 WEST EIGHTH STREET • MISHAWAKA, INDIANA 46544-0783  
FAX: (219) 255-5829 • TOLL FREE: 800-332-7343 • PHONE: (219) 255-4776

#### DEWALD HYDRA-SYNC SYSTEM

**NOTE:** Slide Tube Assemblies and Cylinder may be above, below or through the frame main-rails.

**NOTE:** To allow for independent room seals, there is generally a space between the nylock nut and the jam nuts. THIS SPACE MUST BE MAINTAINED!

Patented System  
(Additional Patents Pending)

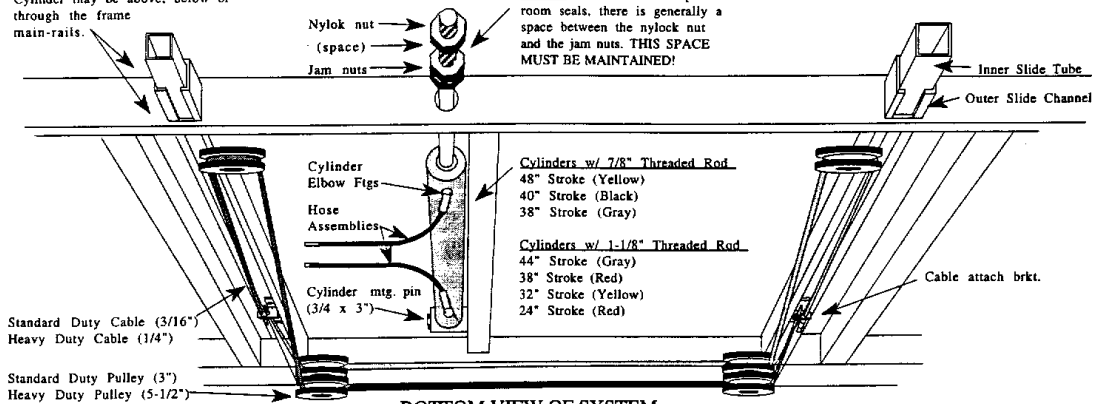

**BOTTOM VIEW OF SYSTEM  
ON VEHICLE FRAME**

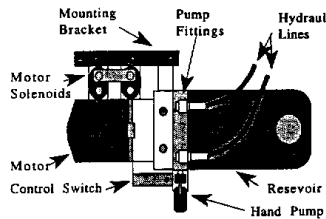

**POWER UNIT**  
For Single Room System  
(No Modular Valve Blocks)

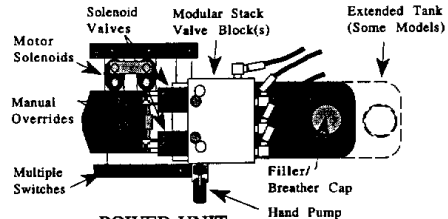

**POWER UNIT**  
(With Valve Block  
for Multiple Functions)

## 2000 LAND YACHT XC 35FT.PUSHER

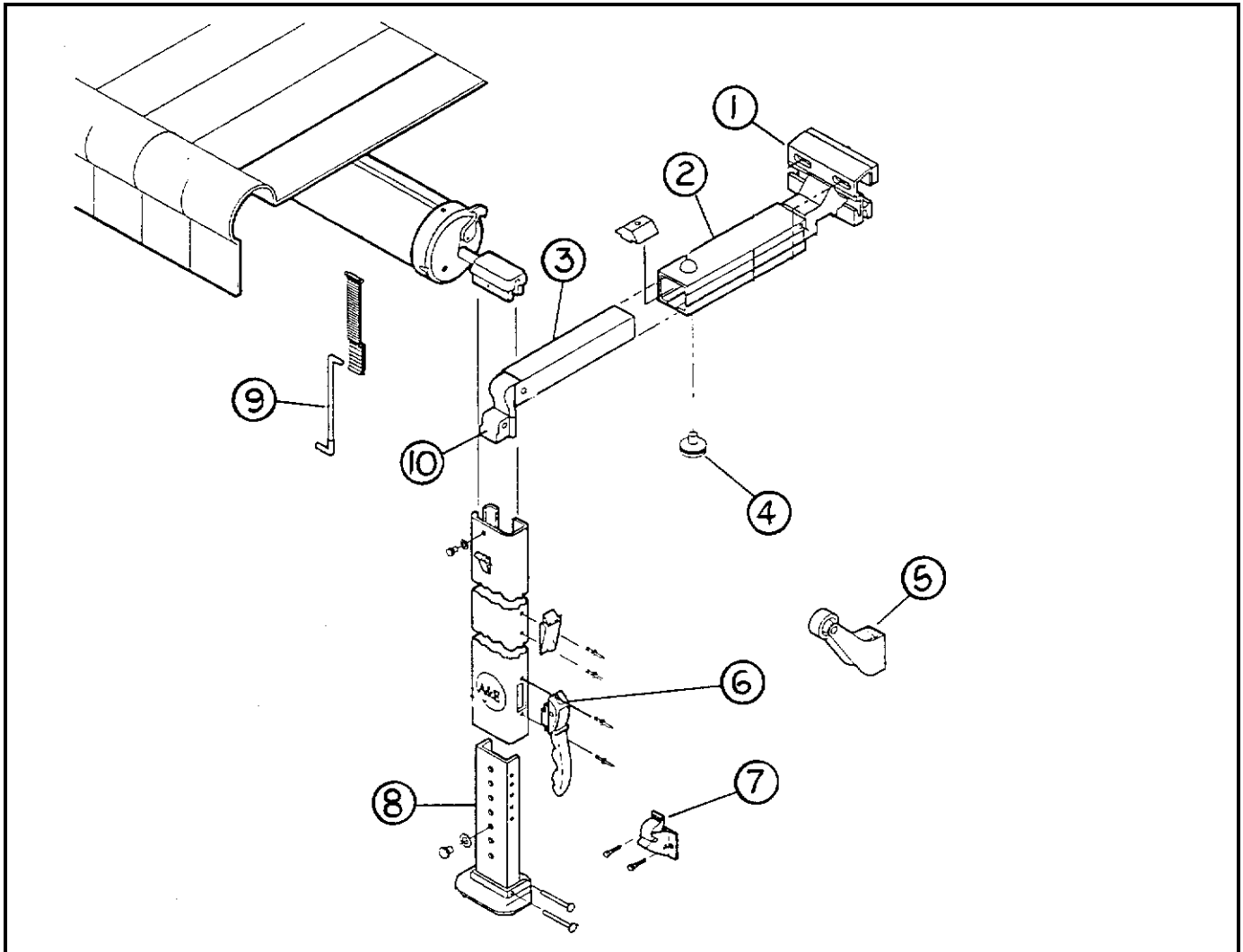

- |                |                                      |
|----------------|--------------------------------------|
| 1) 702679-104  | Bracket top, A&E awning              |
| 2) 702679-103  | Rafter, main, A&E awning             |
| 3) 702679-105  | Secondary rafter, A&E awning         |
| 4) 702679-106  | Knob , adjustment, 1 7/8" A&E awning |
| 5) 702679-109  | Door roller, A&E awning              |
| 6) 702679-111  | Lift handle, A&E awning              |
| 7) 702679-108  | Bracket, bottom mounting, A&E awning |
| 8) 702679-107  | Arm, adjustable, A&E awning          |
| 9) 702679-102  | E-Z pull rod, A&E awning             |
| 10) 702679-110 | Slider assembly, A&E awning          |

# 2000 LAND YACHT XC 35FT.PUSHER

## HARDWARE INTERIOR

381526-01	Drawer slide, 950RV, 14"
381526-03	Drawer slide, 950RV, 18"
381526-05	Drawer slide, 700RV, 22"
381526-06	Rear bracket, adjustable, drawer slide
380203-01	Piano hinge, 1/8" pin, clear anodized
381000-06	Hinge, .092 stainless, 2.0" open, 56"long
380210	Hinge, 2", bed top
381443-01	Sliding door set, includes carriers, top plate and track
200009	Sliding door guide
*381385	Dual lock #400
*381386	Dual lock #170

\*These two parts work similar to Velcro but have interlocking knobs rather than hooks and loops.

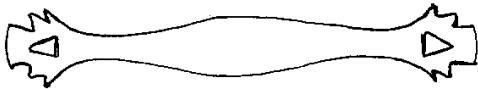

381599 Pull handle,  
drawer/door, antique brass

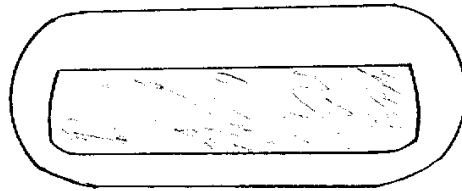

381576 Pull handle,  
brass

# 2000 LAND YACHT XC 35FT.PUSHER

## HARDWARE INTERIOR

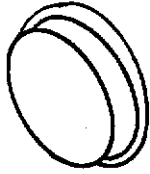

201427 Finger pull,  
light brown

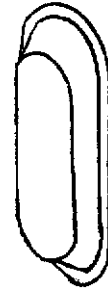

381603 Pull, three finger  
Antique brass

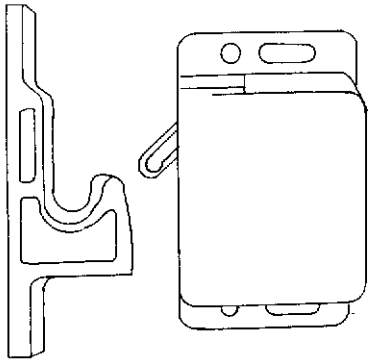

381228 Grabber door latch  
w/catch, 10 lb. Rating  
381228-01 Grabber door latch  
w/catch, 3 lb. rating



381228-100 Catch  
only, grabber door latch

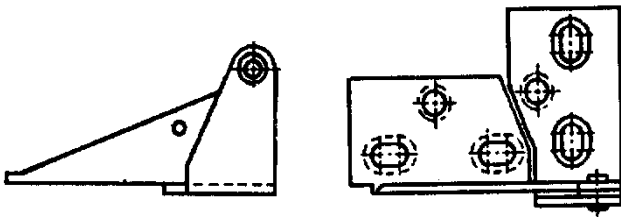

385935 Hinge, pivot, brass  
for bath mirror

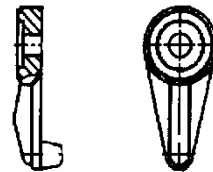

381612 Clip, mirror  
retainer, clear

# 2000 LAND YACHT XC 35FT.PUSHER

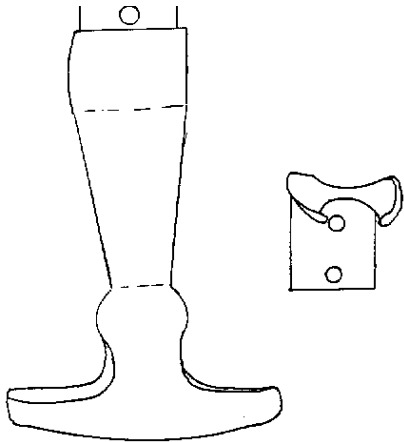

381021 Rubber T latch  
w/catch

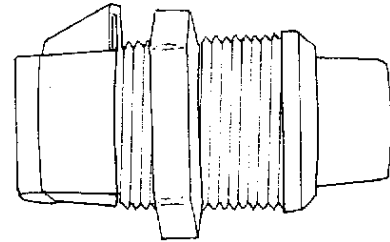

381408 Latch, push button  
black, pantry

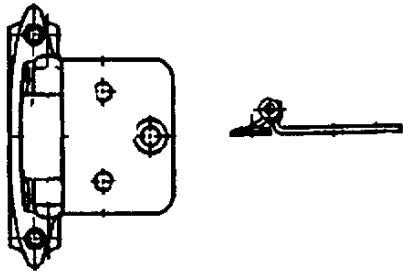

381601 Hinge, Antique brass  
spring loaded

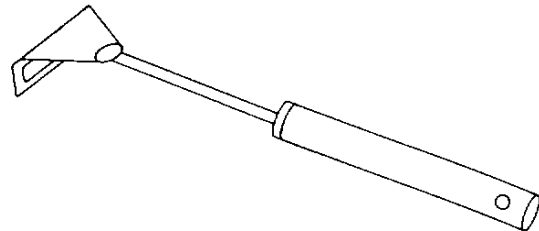

381147 Door support

## 2000 LAND YACHT XC 35FT.PUSHER

381527	Speedy shelf strips
380045	Clothes rod
200975-04	Conduit, flexible, black plastic(covers rod)
380046	Clothes rod mounting bracket
381298	"J" bracket, center clothes rod support
340088	Retainer clip, medicine cabinet door mirrors
381612	Mirror clip, holds mirror in wood frame doors
381263	Bracket, prop w/ball, straight(rear bed top)
381262	Bracket, prop w/ball, angled
381549	Gas spring, SPD-GS-2300-150
381158	Lift handle, rear bed top
381530	Drawer latch, flexible black T handle
381626-02	Towel bar, chrome and brass
380248	Soap holder, chrome
380034	Toilet paper holder, chrome
380017	Holder, toothbrush and tumbler

### WINDOW, SE-GI CO.

371366-100	Weep hole cover, SE-GI window
371366-101	Sweep latch, SE-GI window





# 2000 LAND YACHT XC 35FT.PUSHER

## SECTION III

F through H

FASTENERS (common fasteners available locally are not listed)

Rivets .....	III-1
Screws .....	III-3

### FLOOR COVERING

Carpet.....	III-4
Hardwood flooring.....	III-4
Tile .....	III-4
Mats .....	III-4

### FURNITURE

Interior doors .....	III-5
Mirrors .....	III-6
Drawer face .....	III-7
Drawer box .....	III-7
Bedroom furniture.....	III-8
Bath, slide out .....	III-9
Galley, slide out.....	III-10
Lounge, slide out .....	III-12
Cab .....	III-13

### HARDWARE

Exterior locks .....	III-14
Main door/screen door .....	III-15
Exterior access doors.....	III-17
Slide out room.....	III-19
Awning hardware .....	III-21
Interior hardware.....	III-22



# 2000 LAND YACHT XC 35FT.PUSHER

## LABELS AND TAGS

385103	Plate, RVIA
385531	FMVSS certification label
385815	Name plate, motorhome hitch rating
385095	Tag registry#11999
385465	Label, exit warning (English)
385463	Label, warning label/cooking appliance
385464	Label, LP gas warning label (odor)
385788	Warning label, pilot light/refuel
385101	Tag, auxiliary tank dump valve handle
385099	Tag, black tank dump valve handle
385063	Label, drain cap
385062	Decal, 110-125 voltage AC
385309	Decal, fuel fill
385547	LP gas warning/fill label
385141	Tag, seat, clear w/black letters
385518	Label, dimension and clearance
385193	Label, 12Volt distribution inside
385560	Air conditioner rating label
385561	Generator rating label
385565	Label, holding tank flushing
385805-01	A/C priority switch label-front
385805-02	A/C priority switch label-rear
385812	Label, Calif. hazardous substance
385609	Label, smoke detector
385612	Label, parking brake warning
385829	Decal, fuse and relay
385828	Decal, fuse panel warning
385851	Label, cellular phone

(continued)

# 2000 LAND YACHT XC 35FT.PUSHER

## LABELS AND TAGS

385933	Label, name set relay
385941	Label, waste water holding
385942	Label, sewage holding tank
385943	Label, "cap must be in place"
385947	Label, 10-amp fuse maximum
385098	Label, seat occupancy
385608	Label, sewer hose
385829	Decal, fuse and relay
385828	Decal, fuse panel
385931	Decal sheet, utility compartment
385966	Label, inverter circuit
385988	Decal, water heater
385989	Decal, mirror heat
385946	Label, warning, slide out operation

# 2000 LAND YACHT XC 35FT.PUSHER

## OPTIONS

690413	VCR, Sony Hi-Fi
203153-01	Skylight, 22 x 22 clear
203152-03	Skylight trim out 22 x 22 x 4
702804-02	Shade, pleated, 20.25 x 21.00
*690352-01	Washer/dryer, Combo Matic 2000
962662	Laundry cabinet assembly
381564	Vent w/wall thermostat, Fantastic #2000TRS
690425-03	Refrigerator, 10CF, 2-way, RH, NDR1062, w/ice
801278-044	Refrigerator door insert, 54.88 x 16.69
801278-034	Refrigerator door insert, 54.88 x 10.38
511303	Generator, Onan 7.5 QD
511303-02	Remote start switch w/panel
203111-05	Top RS armrest, diesel
702679-xx	Awning, front door, 4' (see awnings page II-13)
702679-19	Hardware, awning, front bus door
702679-20	Air foil kit, 4' Dometic awning
203245	Armor, body, (front nose shield)
963421-03	Table assembly, free standing dinette
703009	Chair, dinette, folding, Oak

\*Do to availability, Kariba #WDS1043 may be substituted unless otherwise specified. Kariba and Combo Matic both fit in the same cabinet and have the same hook-ups.

# 2000 LAND YACHT XC 35FT.PUSHER

## OPTIONS

690330-30	Air conditioner, 1500 Briskair, w/heat strip
690323-26	Electronic kit, Briskair
690323-21	Heat strip
690380-04	Thermostat
690380-08	Remote sensor
690323-12	Cover, return air, Polar White
410825-02	Leveling kit complete, semi-auto
702897-07	Seat, passenger, w/foot rest & Vibrasonic
511503	Kit, vibrasonic seat
702625-01	Recliner, leather, Villa
703036	Love seat 52", leather, Villa
511511-01	Mirror, cab, exterior, chrome, RS
511511-02	Mirror cab, exterior, chrome, CS

# 2000 LAND YACHT XC 35FT.PUSHER

## PLUMBING

### LPG

601681	LP tank, 50.3 gal, liquid/vapor
511229	Sending unit, 90 ohm, Snap-on
601277	Regulator, LP gas, 2 stage, Marshal Brass
425546	Bracket, LP regulator
201649	Access cover, LP regulator
601335	LP hose, tank to regulator, 35 in.
601527-02	LP hose, high-pressure liquid, 51in.
601527-01	LP hose, high-pressure liquid, 56in.
601279	LP hose, low pressure, 18in.
601412-08	Connector, 1/2" pipe to 3/8" flare
601412-12	Connector, 1/2" pipe to 5/8" flare
601515	Fitting, brass 1/4" x 1/4" inverted flare
601523-23	Fitting, 1/2" hose x 1/2" MPT, brass
601280	Fitting, brass elbow, 1/4" MPT x 1/4" FPT
600008	Tubing, copper, 3/8 in.
600435	Flare nuts, forged, 3/8 in.

# 2000 LAND YACHT XC 35FT.PUSHER

## PLUMBING FRESH WATER-UTILITY COMPARTMENT

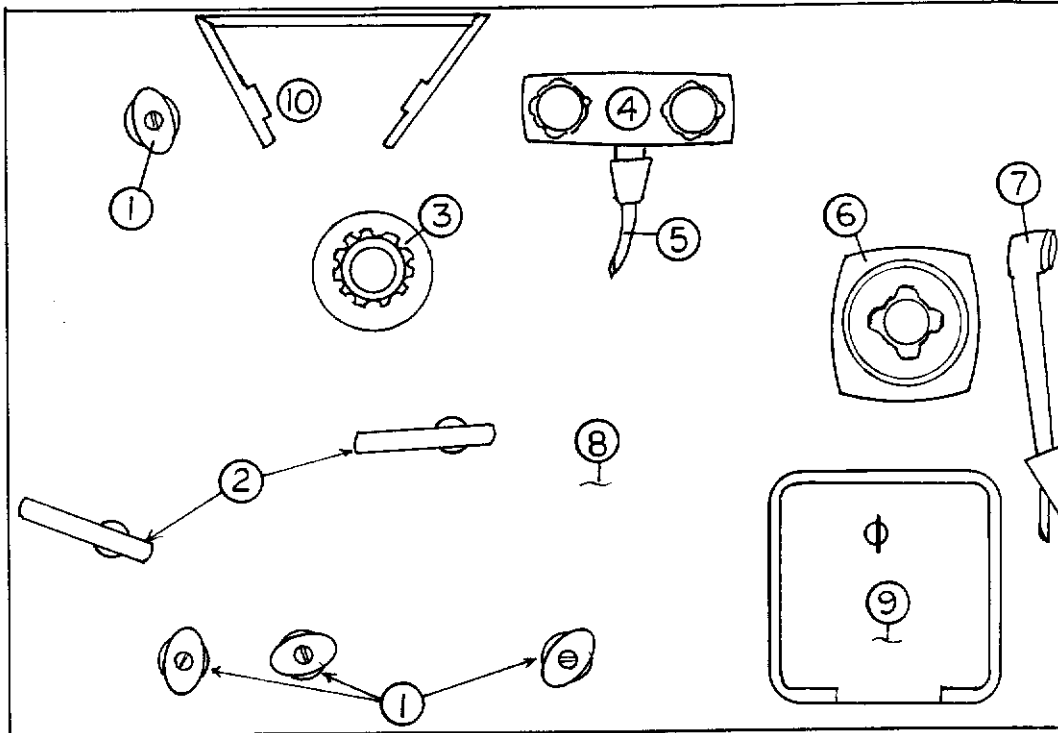

- 1) 601698-07 Shut-off, 1/2" barb x 1/2" barb
- \*2) Dump valve rods
- \*3) 601197-01 Water hook up, black tank flush
- 4) 601592-03 Shower valve
- 5) 601592-02 Shower hose, white, 59in.
- 6) 601392 City water hook-up w/regulator
- 7) 601592-01 Shower head, white
- 8) 386013 Plumbing panel, utility, stainless steel
- 9) 601229-01 Compartment, sewer hose(no metal hose)
- 601610 Metal conduit, 4" x 10'-hose carrier
- 601610-03 Ell, 45 degree-4"
- 601610-04 Cap w/stop-4"
- 10) 203035 Holder, paper towel

\*See drainage for more detail



# 2000 LAND YACHT XC 35FT.PUSHER

## PLUMBING FRESH WATER

- 601612-01 Tank, fresh water, 60gal.
- 601743-01 Tank, fresh water, 75gal. (starts ser.#710679)
- 601709 Check valve, w/rubber flap(over flow)
- 600139 Check valve, brass
- 601061-03 Water pump, Shurflo
- 600668 Filter, pre water pump
- 601392 City water hook-up w/regulator

### FITTINGS

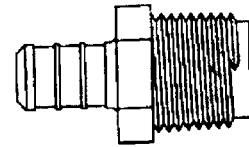
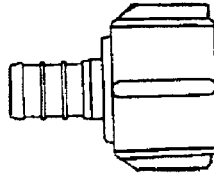
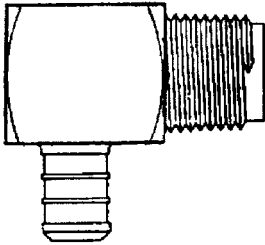

601698-04  
Elbow, 1/2" barb  
x 1/2" MPT

601698-03  
Coupler, 1/2" barb  
x 1/2" FPT

601698-02  
Coupler, 1/2" barb  
x 1/2" MPT

Continued.

# 2000 LAND YACHT XC 35FT.PUSHER

## PLUMBING FRESH WATER-FITTINGS

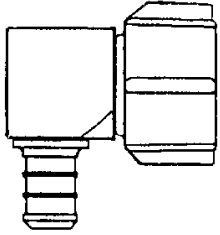

601698-05  
Elbow 1/2" barb x  
1/2" FPT

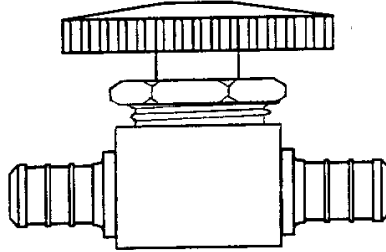

601698-07  
Shut-off, 1/2" barb x  
1/2" barb

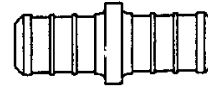

601698-08  
Coupler  
1/2" x 1/2" barb

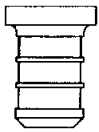

601698-09  
Plug, 1/2" barb

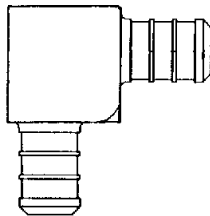

601698-10  
Elbow 1/2" barb x  
1/2" barb

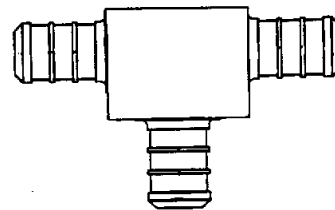

601698-11  
Tee, 1/2" x 1/2" x  
1/2" barb



601698-15  
Crimp ring, 1/2  
E-Pex, 1/2 (black)



601698-01  
E-Pex tube, 1/2"

(continued)

# 2000 LAND YACHT XC 35FT.PUSHER

## PLUMBING FRESH WATER-FITTINGS



601698-16  
Crimp ring,  $\frac{3}{4}$ "  
E-Pex, black



601698-12  
E-Pex tube,  $\frac{3}{4}$ "

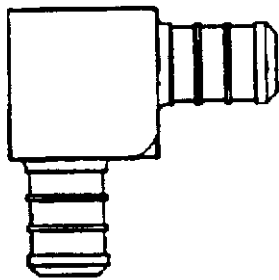

601698-13  
Elbow,  $\frac{3}{4}$ " x  $\frac{3}{4}$ " barb

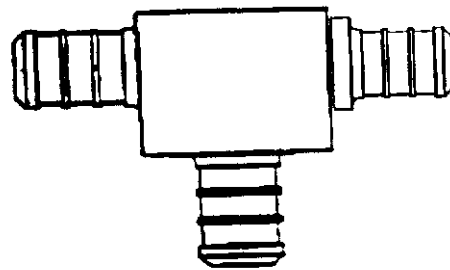

601698-18  
Tee,  $\frac{3}{4}$ " x  $\frac{1}{2}$ " x  $\frac{3}{4}$ " barb

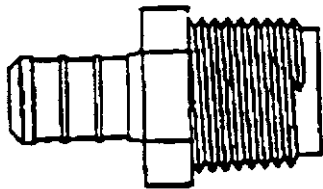

601698-19 Coupler,  $\frac{3}{4}$ " barb x  $\frac{3}{4}$ " MPT

# 2000 LAND YACHT XC 35FT.PUSHER

## PLUMBING FRESH WATER

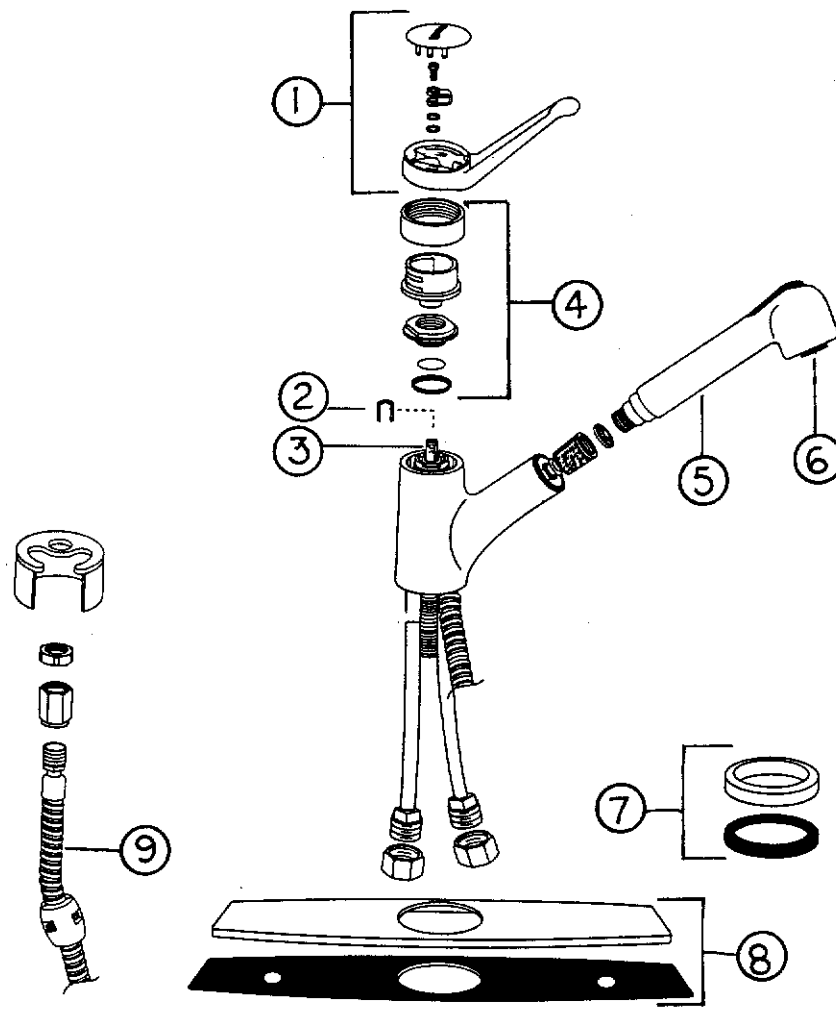

601579-01 Faucet, One Touch, Moen, sand

- |               |                           |
|---------------|---------------------------|
| 1) 601579-103 | Lever handle kit          |
| 2) 601579-105 | Retainer clip             |
| 3) 601579-106 | Cartridge                 |
| 4) 601579-104 | Collar and pivot retainer |
| 5) 601579-100 | Spout                     |
| 6) 601579-101 | Aerator                   |
| 7) 601579-107 | Escutcheon, small         |
| 8) 601579-108 | Escutcheon, large         |
| 9) 601579-109 | Hose                      |

# 2000 LAND YACHT XC 35FT.PUSHER

## PLUMBING FRESH WATER-FAUCETS

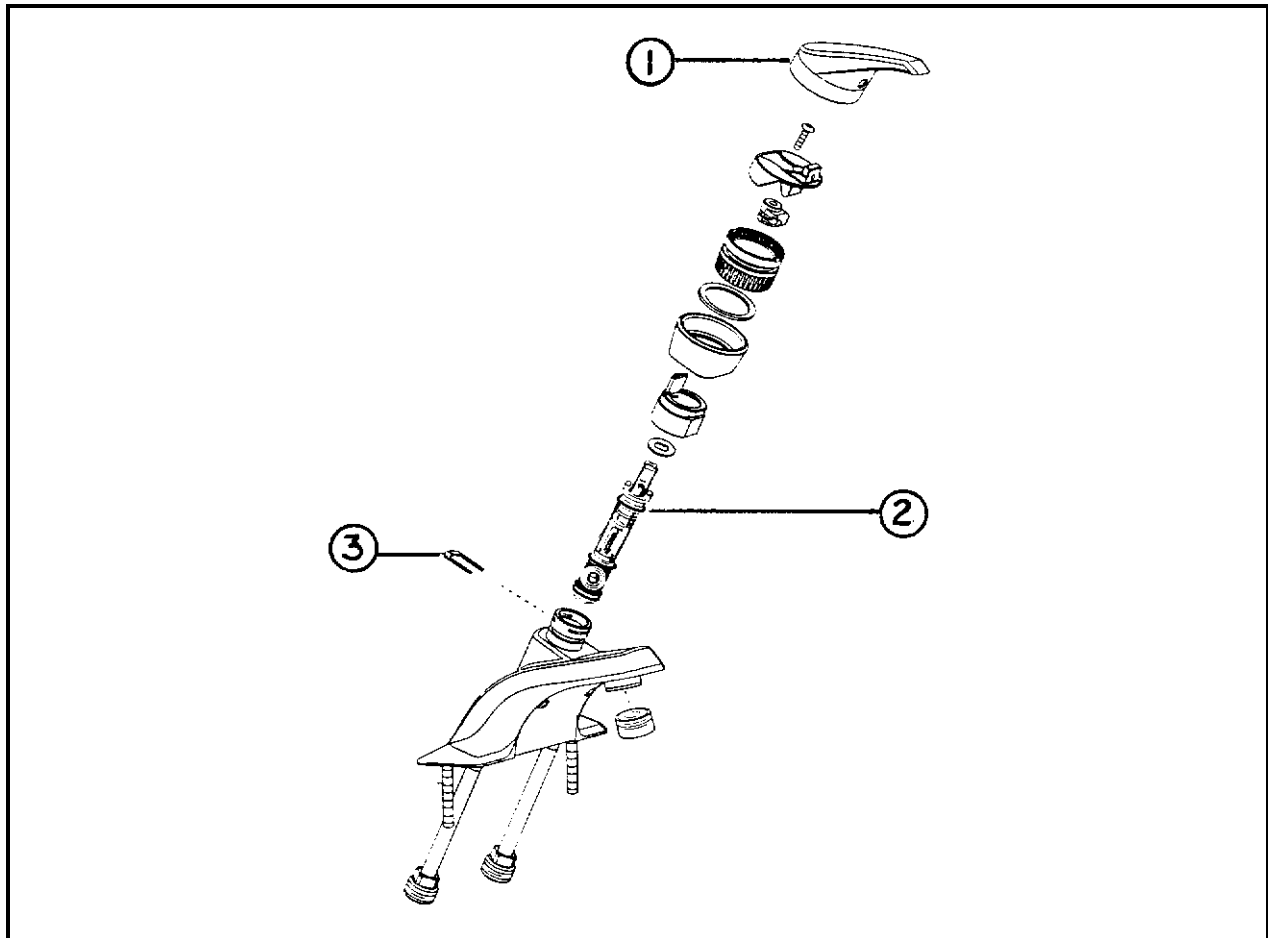

690390-02Faucet, lavatory, Moen, brass/chrome

- |               |               |
|---------------|---------------|
| 1) 690390-100 | Lever handle  |
| 2) 601579-105 | Cartridge     |
| 3) 601579-104 | Retainer clip |

# 2000 LAND YACHT XC 35FT.PUSHER

## PLUMBING FRESH WATER-FAUCETS

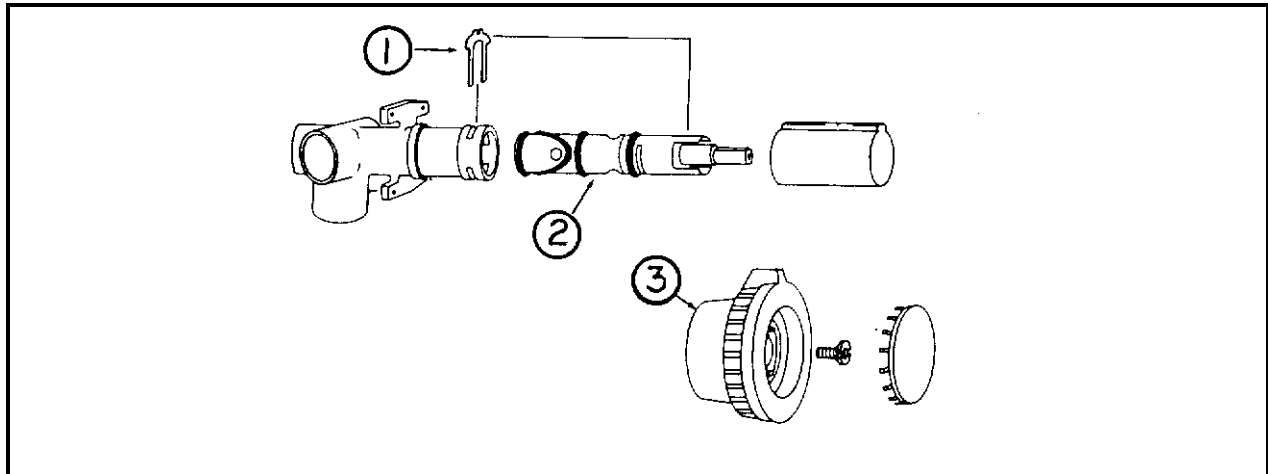

601420-02Faucet, shower

- 1) 000883
- 2) 601420-100
- 3) 001041

Retainer clip  
Cartridge  
Handle

- 601358-100
- 600330
- 600332

Shower head , chrome  
Shower hose, chrome  
Vacuum breaker, chrome

# 2000 LAND YACHT XC 35FT.PUSHER

## PLUMBING FRESH WATER-FAUCETS

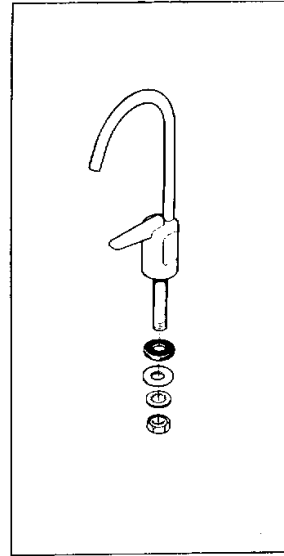
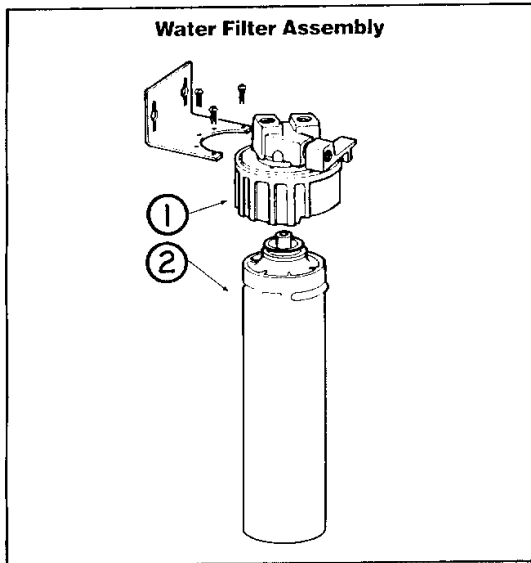

- |           |                    |        |               |
|-----------|--------------------|--------|---------------|
| 1) 005273 | Head, water filter | 601401 | Faucet, water |
| 2) 960112 | Cartridge, filter  |        |               |

# 2000 LAND YACHT XC 35FT.PUSHER

## PLUMBING DRAIN SYSTEM

601644-01	Holding tank, gray
601604-05	Holding tank, black
601441	Tank flush, no-fuss (vacuum breaker and check valve)
601441-01	Nozzle, tank mounted, no-fuss flush
601197-01	Water hook-up, chrome, black tank flush
601607-08	Sewer hose, 20', w/hose adaptor
601229	Compartment, sewer hose storage(less metal housing)
601610	Metal conduit, 4" x 10'-hose carrier
601610-0	Ell, 45 degree-4"
601610-04	Cap with stop-4"
601607-02	Valve assembly, 3"
601607-10	Dump valve rod extension, 19"
601607-04	Extension rod, threaded, 5½"

### FITTING-BELOW FLOOR

195329-229	Reducer adapter, 3" to 1.5"
601251	Adapter.3" termination
0310107	Waste valve adapter
600820	3" Single socket, 90 degree
601160-02	Pipe, ABS, 1.5"
601160-04	Pipe, ABS, 3.0"
601607-06	Bayonet ring, glue on, 3"
601607-07	Bayonet cap, 3"



# 2000 LAND YACHT XC 35FT.PUSHER

## PLUMBING DRAIN SYSTEM-ABOVE FLOOR

- 601266 Closet flange, 3" x 4", slip fit, tank to toilet adp.
- 201999 Shower stall, almond-35 slide out  
601362-02 Drain, polished chrome  
600594 Strainer w/rubber stopper
- 203037 Shower/tub, fiberglass-35 non slide  
601362-02 Drain, polished chrome  
600594 Strainer w/rubber stopper
- 200406-06 Lavy bowl, oval-includes tail, basket and stopper
- 601663-06 Sink, galley, porcelain, almond  
600968 Sink strainer
- 601700 Hose, drain, Kaf-Flex 1.5, galley slide out  
964233 Plumbing support, galley slide out

### FITTINGS, 1.5' PLASTIC

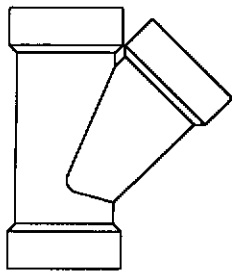

**WYE  
#2301  
600094**

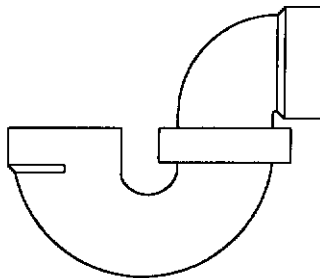

**P-TRAP  
1.5" W/O SLIP NUT  
600144**

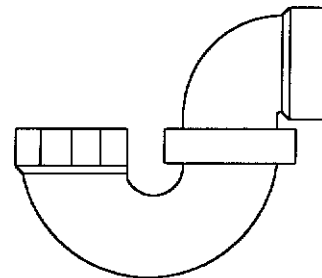

**P-TRAP  
1.5" WITH SLIP NUT  
600622**

(continued)

# 2000 LAND YACHT XC 35FT.PUSHER

## PLUMBING FITTINGS, 1.5" PLASTIC

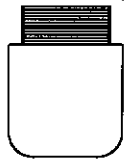

**VENT 1.5"**  
**600538**



**PLUG 1.5"**  
**600155**



**CAP 1.5"**  
**601677**

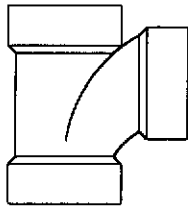

**TEE-SANITARY**  
**1.5"**  
**600156**

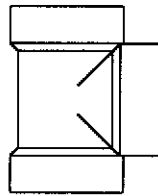

**TEE-BI DIRECTIONAL**  
**CLEAN-OUT 1.5"**  
**601318**

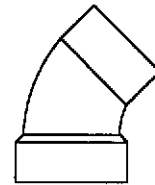

**ELBOW 45D**  
**LONG ST**  
**600027**

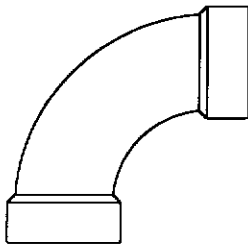

**ELBOW 90D**  
**LONG TURN**  
**600035**

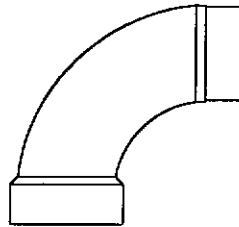

**ELBOW 90D**  
**LONG ST**  
**600431**

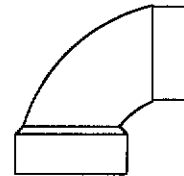

**ELBOW 90D**  
**SHORT ST**  
**600662**

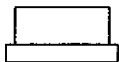

**REDUCER 1.5" TO 1.25"**  
**601263**



**ADAPTER**  
**601676**

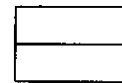

**ADAPTER**  
**W/FEMALE THREADS**  
**600308**

(continued)

# 2000 LAND YACHT XC 35FT.PUSHER

## PLUMBING

### FITTINGS, 1.5" PLASTIC

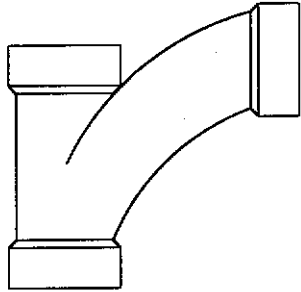

**WYE 1.5"  
1/8" BEND  
600182**

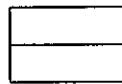

**COUPLING  
1.5"  
600227**

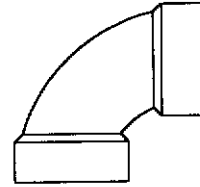

**ELBOW 90D  
SHORT SWEEP  
601636**

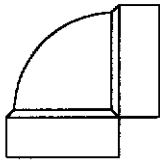

**ELBOW VENT  
90D  
600033**

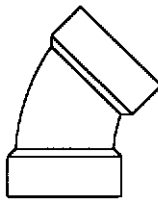

**ELBOW 45D  
LONG TURN  
600030**

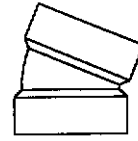

**ELBOW 22.5D  
SHORT TURN  
600116**

# 2000 LAND YACHT XC 35FT.PUSHER

## PLUMBING

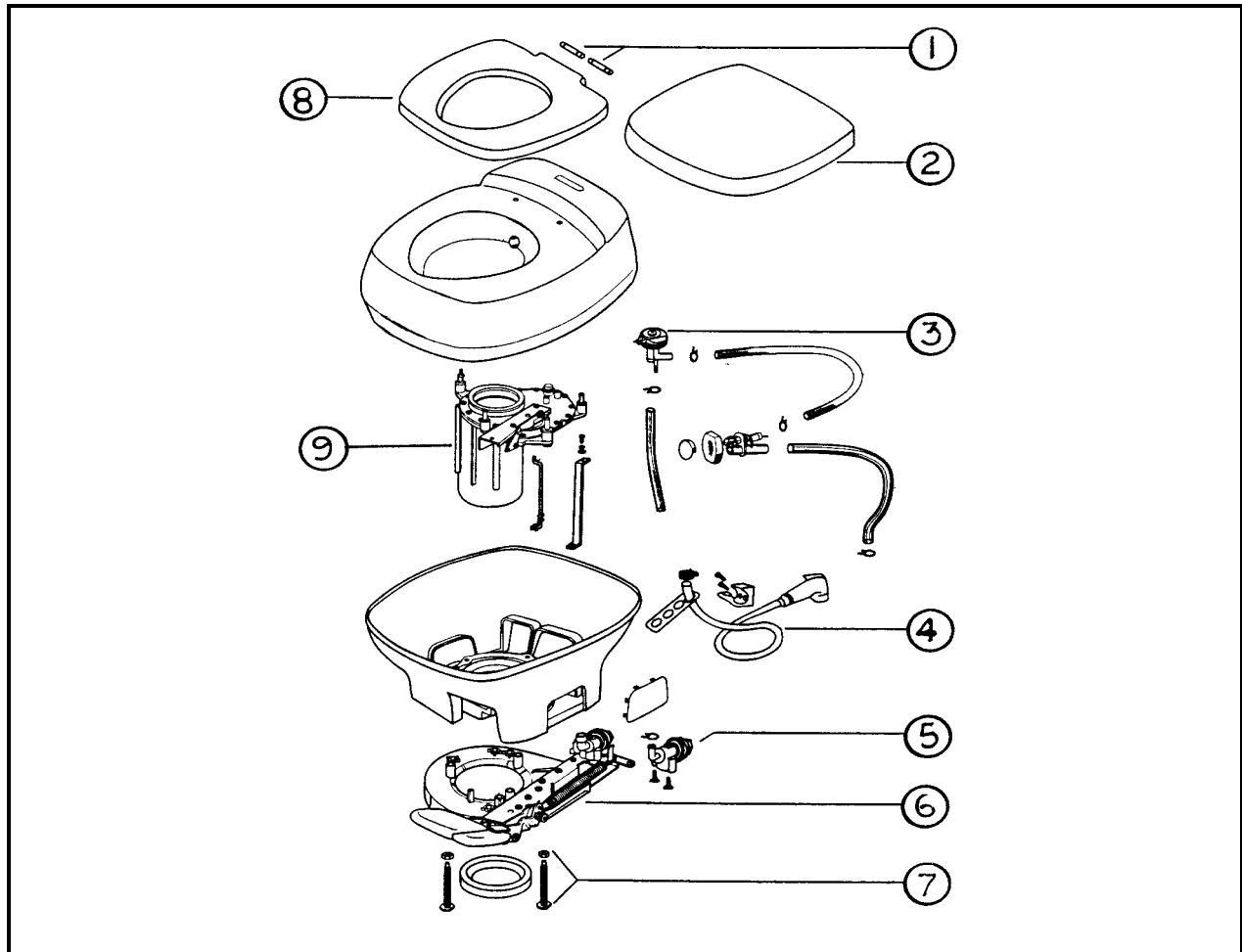

690386 Toilet, Thetford China, Aurora, bone

- |               |  |
|---------------|--|
| 1) 690386-101 | Hinge pins, seat, Aurora               |
| 2) 690386-102 | Seat cover, bone, Aurora               |
| 3) 690386-103 | Vacuum breaker, Aurora                 |
| 4) 690386-104 | Hand spray kit, Aurora                 |
| 5) 690386-105 | Ball valve kit, Aurora                 |
| 6) 690386-106 | Lower mechanism assembly, bone, Aurora |
| 7) 690386-107 | Closet flange seal & bolt kit          |
| 8) 690386-108 | Seat, bone, Aurora                     |
| 9) 690386-109 | Upper mechanism assembly, bone, Aurora |

# 2000 LAND YACHT XC 35FT.PUSHER

## SAFETY EQUIPMENT

510781	Detector, smoke #1056 w/silencer
511343	Detector, carbon monoxide-9 volt
511309	Detector, LPG
510734	Alarm, back-up
381069	Seat belt kit, cocktail chair
690381-01	Fire extinguisher 10 B:CUL
690381-02	Fire extinguisher 10 B:CULC (Canadian)
380188	Emergency warning triangle, set of 3

# 2000 LAND YACHT XC 35FT.PUSHER

## SEALER, GASKETS, PAINT, ADHESIVES GASKETS



1) 365205



2) 365237-01



3) 365232



4) 365214



5) 201260



6) 381524



7) 381665



8) 365013-01



9) 365009

- 1) 365005
- 2) 365237-01
- 3) 365232
- 4) 365214
- 5) 201260
- 6) 381524
- 7) 381655
- 8) 365013-01
- 9) 365009

- Gasket, weather strip, rear trunk door
- Seal, dust, compartment door edge
- Seal, main door/compartment door jamb
- Gasket, seal-compartment door hinge and main doorjamb
- Insert, windshield gasket, rubber
- Gasket, windshield, includes center strip
- Gasket, window to body, door jamb
- Gasket, screen door, low-density foam
- Gasket, screen door, at bottom notch

# 2000 LAND YACHT XC 35FT.PUSHER

## SEALS

Sealer, gaskets, paint, adhesives

### GASKETS-SE-GI WINDOWS



1) 371366-103



2) 371366-102



3) 371366-104



4) 371366-105

- 1) 371366-103
- 2) 371366-102
- 3) 371366-104
- 4) 371366-105

- Track, window screen, Se-Gi
- Track, sliding pane, Se-Gi
- Wiper seal, vertical, Se-Gi
- Screw cover, clamp ring, Se-Gi

# 2000 LAND YACHT XC 35FT.PUSHER

## SEALER, GASKETS, PAINT, ADHESIVES

### SEALER

360052	Vulkem sealer, black,
360180	Sika flex #221
360268-01	Liqua Seal, roof, white
360216	Caulk, latex, brown
365001	Tape, double coated foam
360074	Sealant, GE RTV, white
360002	Vulkem sealant, gray
360176	Sealant, almond, bathroom
360210	Sealant, paralastic #4334-04 (refrigerator compartment sealer)
360283	Silicone sealer, Corian bone



# 2000 LAND YACHT XC 35FT.PUSHER

## SEALER, GASKETS, PAINT, ADHESIVES

### ADHESIVES

702791	Border adhesive
800639-02	Adhesive, Oak plank flooring
360270	Adhesive spray, Sta-put, ceiling panels (reference only, not available for shipment)
360261	Glue, urethane

### PAINT

Each vehicle has been provided with a sheet listing the paint color codes on that particular motorhome. Also, each motorhome is shipped with touch-up paint for each color.

A back up color chart for each motorhome is kept in Airstream's files. If calling Airstream for this information ask for "Sales" and have the serial number available for them.

360292	Stain, Saratoga Oak (new for year 2000)
365244	Lacquer, clear, used on wood

### MISCELLANEOUS

360179	Undercoat, Pennzoil II
6000329	Tape, silver, 2" wide
200518	Spline, gray, screen insert
380079	Screen, gray

# 2000 LAND YACHT XC 35FT.PUSHER

## UPHOLSTERY/FOAM/MATTRESS

702675 Mattress, 60 x 80" w/45 degree corner  
701611 Pillow 21 x 31"

\*702677-399 Bedspread , Roman Sands

963096 Head board, 62"wide

702901-01 Swivel chair, Villa

\*702899-399 Sofa, jackknife, 68", Villa, 35' slide out, Roman Sands

702897-01Seat, driver, power w/belts

702898-01Seat, passenger, non-power, w/belts

\*Changing the-(dash) number to:

318 = Blue Bayou  
258 = South Beach  
248 = Vintage Leaf  
379 = Mosaic Blue  
389 = Tropical Isle

# 2000 LAND YACHT XC 35FT.PUSHER

## UPHOLSTERY/FOAM/MATTRESS

### PILLOW KIT- ROMAN SANDS

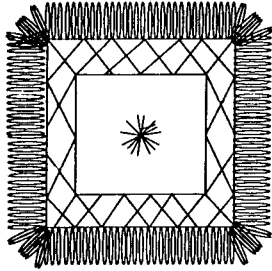

703032-01 Lounge accent pillow

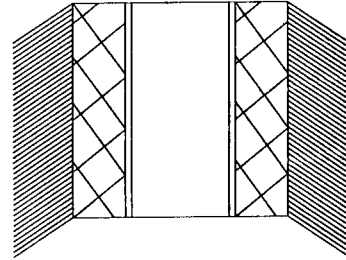

703032-02 Lounge accent pillow

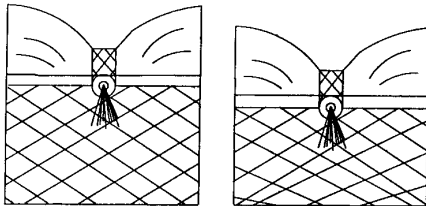

703032-03 Lounge accent pillows

703032-04(chair)

703032-05 Sham, Queen

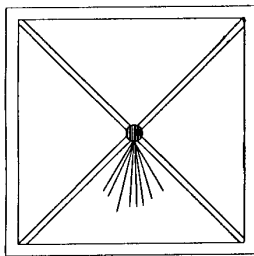
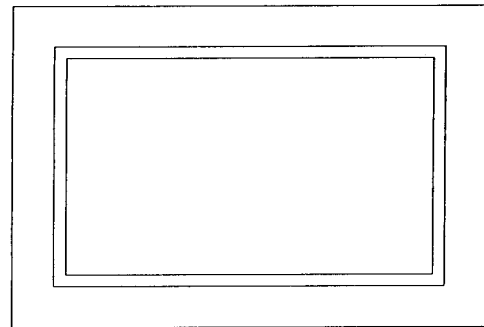

703032-06 Bedroom accent pillow

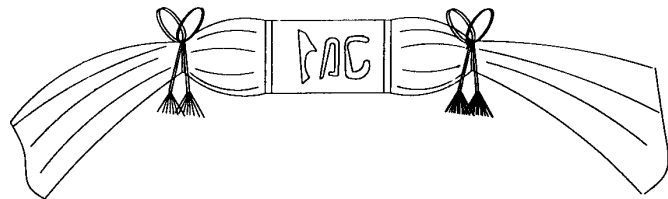

703032-07 Bedroom accent pillow

# 2000 LAND YACHT XC 35FT.PUSHER

## UPHOLSTERY/FOAM/MATTRESS

### PILLOW KIT-VINTAGE LEAF

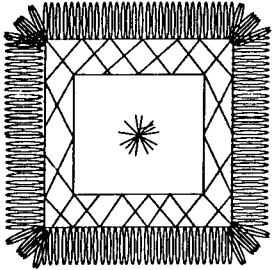

703031-01 Lounge  
accent pillow

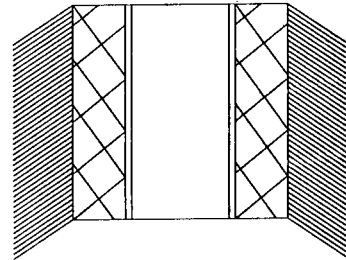

703031-02 Lounge  
accent pillow

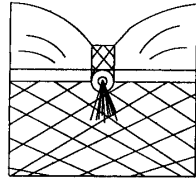
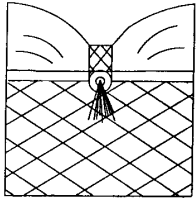

703031-03  
Lounge accent pillows

703031-04(chair)

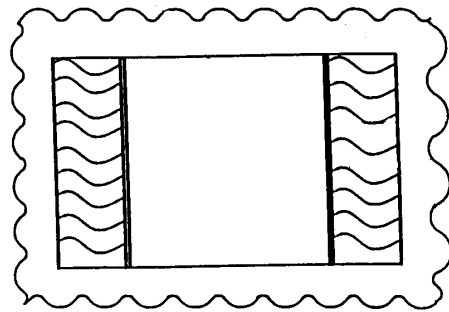

703031-05 Sham, Queen

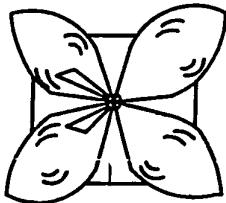

703031-06 Bedroom  
accent pillow

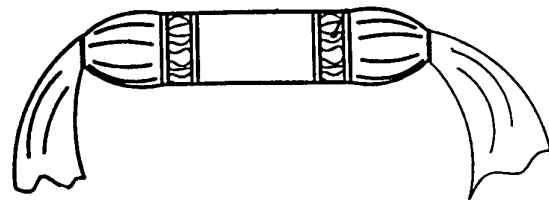

703031-07 Bedroom accent pillow

# 2000 LAND YACHT XC 35FT.PUSHER

## UPHOLSTERY/FOAM/MATTRESS

### PILLOW KIT-MOSAIC BLUE

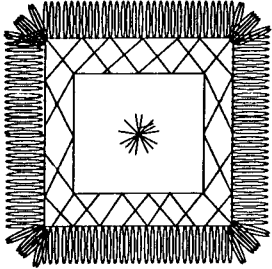

703033-01 Lounge  
accent pillow

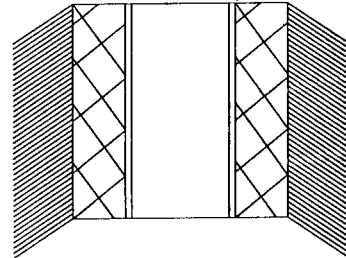

703033-02 Lounge  
accent pillow

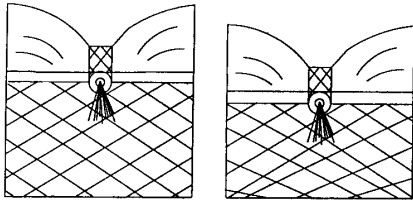

703033-03703033-04(chair)  
Lounge accent pillows

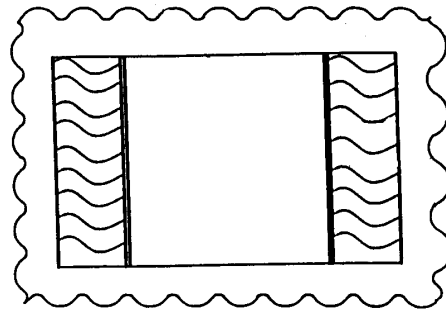

703033-05 Sham, Queen

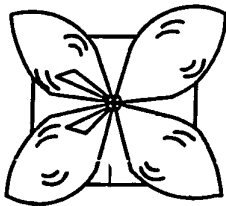

703033-06 Bedroom  
accent pillow

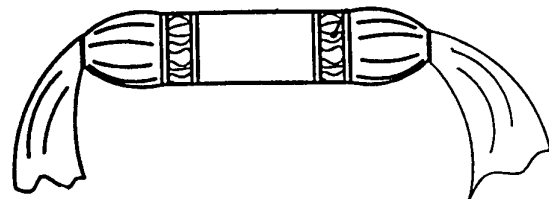

703033-07 Bedroom accent pillow

# 2000 LAND YACHT XC 35FT.PUSHER

UPHOLSTERY/FOAM/MATTRESS

PILLOW KIT- SOUTH BEACH

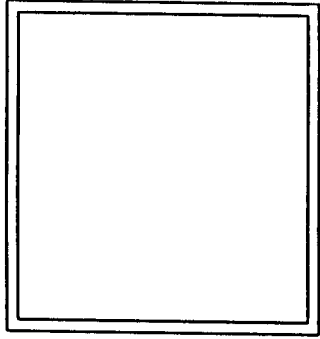

702926-01 Lounge accent pillow

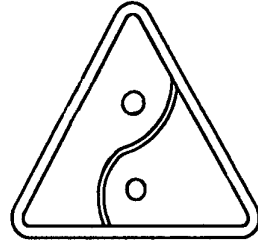

702926-02 Bedroom accent pillow

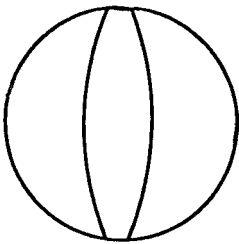

702926-03 Bedroom accent pillow

# 2000 LAND YACHT XC 35FT.PUSHER

UPHOLSTERY/FOAM/MATTRESS

## PILLOW KIT- SOUTH BEACH

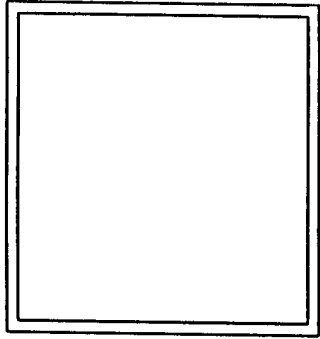

702926-01 Lounge accent pillow

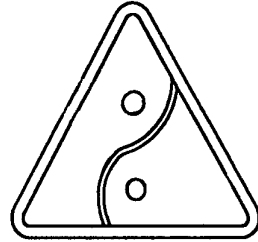

702926-02 Bedroom accent pillow

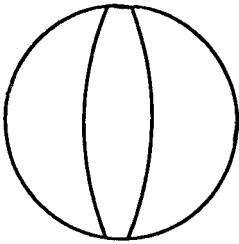

702926-03 Bedroom accent pillow

# 2000 LAND YACHT XC 35FT.PUSHER

UPHOLSTERY/FOAM/MATTRESS

PILLOW KIT- BLUE BAYOU

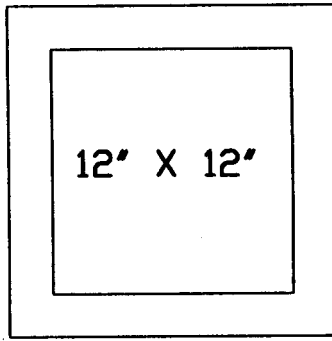

702896-01 Lounge accent pillow

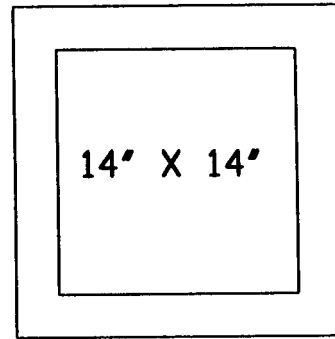

702896-02 Bedroom accent pillow

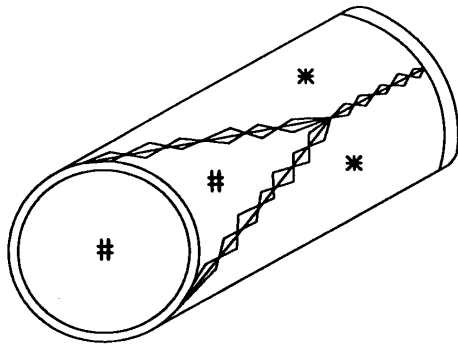

702896-03 Bedroom accent pillow



# 2000 LAND YACHT XC 35FT.PUSHER

## UPHOLSTERY/FOAM/MATTRESS

964500	Upholstered back, aft dinette
702464-19	Foam, dinette, upper back, RH
702464-07	Foam, dinette, lower back
964501	Upholstered back, forward dinette
702464-20	Foam, dinette, upper back, LH
702464-07	Foam, dinette, lower back
998070	Cover, seat, side dinette
702464-09	Foam, dinette, aft seat
702464-11	Foam, dinette, forward seat
998071	Cover, back, side dinette

# 2000 LAND YACHT XC 35FT.PUSHER

## VENTS/FANS

381207-02	Vent w/screen, refrigerator, roof
511152-11	Range exhaust, w/monitor
511152-01	Vent cover, exterior, range exhaust
203148-01	Skylight, heavy duty, 14.5" x 22.5"
203148-02	Trim dome, inner, skylight, 14" x 22"
381541-06	Roof vent w/power lift
381541-02	Switch, roof vent
381450	Vent, roof, Fantastic #6000RBT
511376	Fan, defrost, oscillating
381631-01	Skylight, plastic, neo-angle 22" x 22"

# 2000 LAND YACHT XC 35FT.PUSHER

## WOOD/INTERIOR TRIM

801261	Paneling, interior wall, 1/8" x 4'x8', Antiquity Buff
203159-02	Trim, divider bar, interior panels, Antiquity Buff
800507-01	Paneling, Luan, 1/8" x 4'x8'
800397-01	Cedar, planked, 5/32" x 4'x8'
201728-01	Extrusion, ceiling trim retainer
201728-04	Extrusion, ceiling trim
801283-01	Paneling 1/2" x 4' x 8', G2S, Antiquity Buff
801274	Paneling 1/2" x 4' x 8', G1S, Antiquity Buff
801180-004	Paneling 1/2" x 4' x 7', G2S, Oak/Oak
801179-004	Paneling, 1/2" x 4' x 7', G1S, Oak/raw
801182-004	Paneling 5/32" x 4' x 7', G2S, Oak/Oak
801181-004	Paneling 5/32" x 4' x 7', G1S, Oak/raw
801229	Laminate, Oak, 4' x 8'
365251-01	Tape, seam, Antiquity Buff, 1 1/8" wide
365251-02	Tape, seam, Antiquity Buff, 8" wide
365251-03	Tape, seam, Antiquity Buff, 12" wide
800631	Handrail, Oak, 23"
963990	Magazine rack

# 2000 LAND YACHT XC 35FT.PUSHER

## WOOD/INTERIOR



1) 801206-014



2) 964152-014

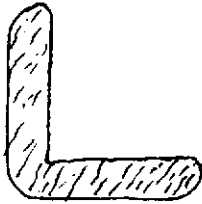

3) 801175-04



4) 800571-014



5) 800617-014



6) 801172-014

6a) 801172-04



7) 801173-034



8) 801173-044

1) 801206-014

Molding, floor, Oak, 43"

2) 964152-014

Molding, chair rail, Oak

3) 801175-04

Molding, corner, Antiquity Buff

4) 800571-014

Molding, Oak, flat 1/4" x 33/64" x 80"

5) 800617-014

Molding, wainscoat, Oak

6) 801172-014

Molding, flexible corner, Oak

6a) 801172-04

Molding, flexible corner, Antiquity Buff

7) 801173-034

Molding, flat radius, .88" Oak

8) 801173-044

Molding, flat radius, 1.13" Oak

(trim continued)

# 2000 LAND YACHT XC 35FT.PUSHER

## WOOD/INTERIOR TRIM

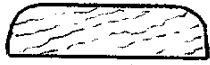

1) 800573-014



2) 800572-01



3) 201728-03

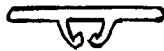

4) 201728-01



5) 203159-02



6) 201666

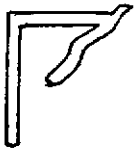

7) 201790-01

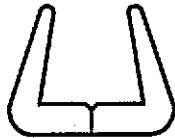

8) 203138-03

1) 800573-014

2) 800572-01

3) 201728-03

4) 201728-01

5) 203159-02

6) 201666

7) 201790-01

8) 203138-03

Molding, door edge 1 3/32 x 80"

Molding, panel edge, Oak 23/32 x 80"

Extrusion, ceiling trim, beige

Extrusion, ceiling trim retainer

Trim, divider bar, interior panels,  
Antiquity Buff

Molding, J 3/16", plastic

Molding, cove, white, ceiling to wall

Extrusion, wall, plastic, beige (panel edging)

# 2000 LAND YACHT XC 35FT.PUSHER

## WOOD/INTERIOR TRIM

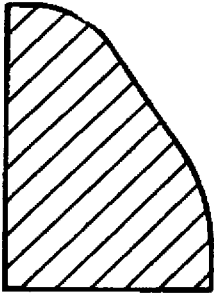

1) 800576-014



2) 801189

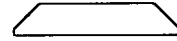

3) 801178-03

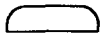

4) 801173-014

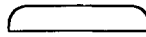

5) 801173-024

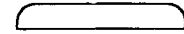

6) 801173-034

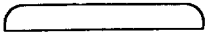

7) 801173-044

- |               |   |
|---------------|---|
| 1) 800576-014 | Molding, bath doorstop, Oak                 |
| 2) 801189     | Trim, bath doorjamb, Oak                    |
| 3) 801178-03  | Flat molding, vinyl wrapped, Antiquity Buff |
| 4) 801173-014 | Flat molding, vinyl wrapped, Oak, .50 wide  |
| 5) 801173-024 | Flat molding, vinyl wrapped, Oak, .75 wide  |
| 6) 801173-034 | Flat molding, vinyl wrapped, Oak, .88 wide  |
| 7) 801173-044 | Flat molding, vinyl wrapped, Oak, 1.13 wide |

## SLIDE OUT ROOM INTERIOR TRIM

- |            |  |
|------------|--|
| 964267-004 | Molding, decorative Oak, slide out trim, 84"   |
| 964267-014 | Molding, decorative Oak, slide out trim, 120"  |
| 964101-024 | Facia, decorative Oak, corner block, slide out |

# 2000 LAND YACHT XC 35FT.PUSHER

## WOOD/INTERIOR TRIM



1) 801289

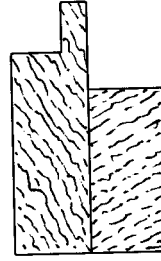

2) 801290

1) 801289 Trim, step, entrance

2) 801290 Trim w/ledge, step, entrance







